

CULTURE AND PROPAGATION OF STRIPED BASS AND ITS HYBRIDS

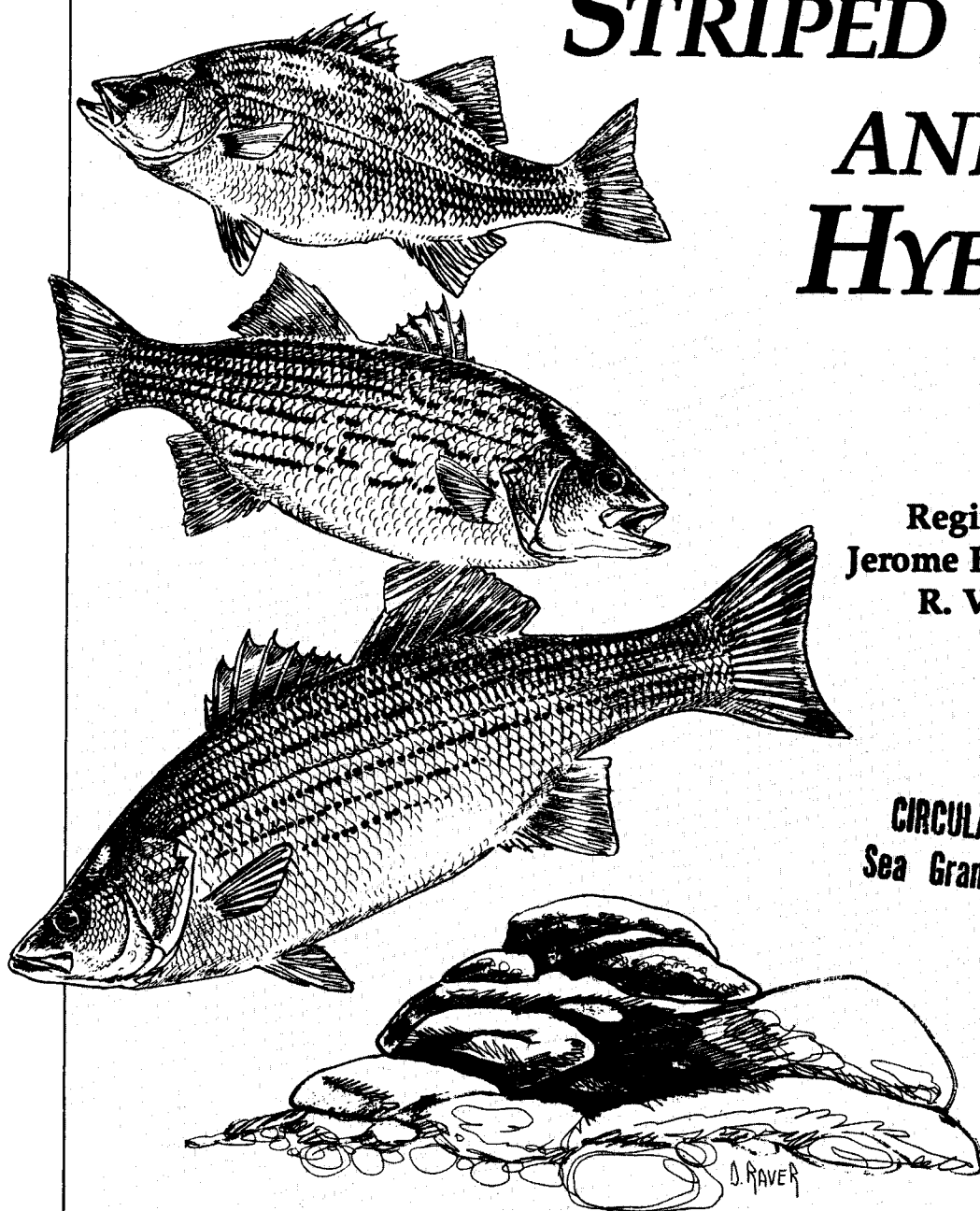

Edited by

Reginal M. Harrell
Jerome Howard Kerby
R. Vernon Minton

CIRCULATING COPY
Sea Grant Depository

LOAN COPY ONLY

CULTURE AND PROPAGATION OF STRIPED BASS AND ITS HYBRIDS

Edited by

Reginal M. Harrell
University of Maryland
Center for Environmental and Estuarine Studies
Horn Point Environmental Laboratories

Jerome Howard Kerby
Fish Culture Research Laboratory
U.S. Fish and Wildlife Service

R. Vernon Minton
Alabama Department of Conservation
and Natural Resources
Marine Resources Division

NATIONAL SEA GRANT DEPOSITORY
PELL LIBRARY BUILDING
URI, NARRAGANSETT BAY CAMPUS
NARRAGANSETT, RI 02882

Striped Bass Committee
Southern Division
American Fisheries Society
Bethesda, Maryland

Harrell, Reginal M., Jerome Howard Kerby, and R. Vernon Minton, editors. 1990. Culture and Propagation of Striped Bass and its Hybrids. Striped Bass Committee, Southern Division, American Fisheries Society, Bethesda, Maryland.

Copyright © 1990 by the Striped Bass Committee
Southern Division, American Fisheries Society
Bethesda, Maryland

Designed and prepared by the Maryland Sea Grant College
University of Maryland, College Park

Second Printing, 1992

Library of Congress Catalog Card Number: 90-083071
ISBN 0-913235-66-0
Printed in the United States of America

University of Maryland Center for Environmental
and Estuarine Studies Contribution No. 2132

Address orders to:

American Fisheries Society
5410 Grosvenor Lane, Suite 110
Bethesda, Maryland 20814

\$ 36.⁰⁰ non-members

* \$ 30.⁰⁰ -members AFS

payable to : American Fisheries Soc.

Dedication

In 1965, a group of individuals with tremendous vision met to discuss and share their experiences and understanding of a promising species, striped bass. This group was formed as a subcommittee of the Reservoir Technical Committee of the Southern Division, American Fisheries Society. It soon became a full Technical Committee of the Division and began synthesizing available information about the culture, life history, and management of this fish. In 1976 the committee published the first comprehensive manual on the culture of striped bass, *Guidelines for Striped Bass Culture*. The Committee is still strong today and, as evidenced by this new manual, its original focus on information dissemination has not changed from the original charter.

We proudly dedicate this updated and revised manual to the memory and honor of the original striped bass subcommittee members and editors of the first manual. The first manual was authored by the 1975 members of the Striped Bass Committee and their names are provided in the original manual.

Original Subcommittee Members

Alabama, Sam Spencer
Arkansas, Ed McGill*
Florida, Forrest Ware
Georgia, Glenn McBay*
Kentucky, Charles Bowers*
Louisiana, Arthur Williams*
Maryland, Charlie Fresbie
Mississippi, Billy Joe Grantham*
Missouri, Charles Suppes*
North Carolina, Hilton Phillips*
Oklahoma, Jack Harper*
South Carolina, Jack Bayless*
Tennessee, David Bishop*
Texas, Ed Bonn
Virginia, Jack Hoffman*
USFWS, Robert Stevens*

Guidelines Editors

Edward W. Bonn
William M. Bailey
Jack D. Bayless
Kim E. Erickson
Robert E. Stevens

* *Members who attended the organizational meeting.*

**Members of the 1990
Striped Bass Technical Committee
Southern Division, American Fisheries Society**

Richard. O Anderson, *U.S. Fish and Wildlife Service*
Robert L. Curry, *North Carolina*
Thomas A. Curtis, *South Carolina*
Robert S. Early, *Maryland*
Benjamin Florence, *Maryland*
T. Michael Freeze, *Keo Fish Farms*
James G. Geiger, *U.S. Fish and Wildlife Service*
Michael D. Gibson, *Arkansas*
Reginal M. Harrell, *University of Maryland*
Michael C. Hearn, *Kentucky*
Lynn T. Henry, *North Carolina*
Jerome Howard Kerby, *U.S. Fish and Wildlife Service*
Fred D. Leckie, *West Virginia*
Robert E. Legler, *Missouri*
Janice H. Little, *Louisiana*
Roger L. McCabe, *Texas*
R. Vernon Minton (Chairman), *Alabama*
Larry C. Nicholson, *Mississippi*
Robert A. Rees, *Georgia*
Wilmer A. Rogers, *Auburn University*
James M. Smith, *Tennessee*
Theodore I. J. Smith, *South Carolina*
Steven L. Spade, *Oklahoma*
Charles C. Starling, *Florida*
Curtis G. Summerlin, *Mississippi*
Raj Tilak, *District of Columbia*
Charles J. Turner, *Alabama*
Gene E. Vaughn, *Duke Power Company*
David K. Whitehurst, *Virginia*
L. Curry Woods, III, *University of Maryland*
William B. Wrenn, *Tennessee Valley Authority*
David M. Yeager, *Florida*
Constance H. Young, *Mississippi State University*

Contributing Authors

Daniel L. Brewer

Kentucky Fish and Wildlife Service
Minor Clark Hatchery
120 Fish Hatchery Road
Morehead, Kentucky 40351

Terry E. Cheek

Tennessee Wildlife Resources Agency
P.O. Box 40747
Ellington Agriculture Center
Nashville, Tennessee 37204

James G. Geiger

U.S. Fish and Wildlife Service
Division of Fish and Wildlife
Management Assistance
1849 C Street, N.W., 820 ARLSP
Washington, D.C. 20240

Reginal M. Harrell

University of Maryland
Center for Environmental and
Estuarine Studies
Horn Point Environmental Laboratories
P.O. Box 775
Cambridge, Maryland 21613

Janice Little Hughes

Louisiana Department of Wildlife
and Fisheries
P.O. Box 4004
Monroe, Louisiana 71211

Wallace E. Jenkins

South Carolina Wildlife and Marine
Resources Department
Marine Resources Research Institute
P.O. Box 12559
Charleston, South Carolina 29412

Jerome Howard Kerby

Fish Culture Research Laboratory
U.S. Fish and Wildlife Service
P.O. Box 700
Kearneysville, West Virginia 25430

Gerald T. Klar

U.S. Fish and Wildlife Service
Marquette Biological Station
446 E. Crescent
Marquette, Michigan 49855

Fred D. Leckie, Jr.

Virginia Game and Inland
Fisheries Commission
P.O. Box 11104
Richmond, Virginia 23230

Ronald E. Lewis

Duke Power Company
Production Environmental Services
Route 4, P.O. Box 351
Huntersville, North Carolina 28078

Roger L. McCabe

Texas Parks and Wildlife Department
1601 E. Crest Drive
Waco, Texas 76750

R. Vernon Minton

Alabama Department of Conservation
and Natural Resources
Marine Resources Division
P.O. Drawer 458
Gulf Shores, Alabama 36542

Andrew J. Mitchell

U.S. Fish and Wildlife Service
P.O. Box 860
Stuttgart, Arkansas 72160

Jerry L. Moss

Alabama Department of Conservation
and Natural Resources
P.O. Box 163
Tuscaloosa, Alabama 35402

Anthony W. Mullis

North Carolina Wildlife Resources
Commission
Route 2, P.O. Box 166
Denton, North Carolina 27239

Larry C. Nicholson
Gulf Coast Research Laboratory
P.O. Box 7000
Ocean Springs, Mississippi 39564

Nick C. Parker
U.S. Fish and Wildlife Service
Texas Cooperative Fish and Wildlife
Research Unit
Texas Tech University
Lubbock, Texas 79409-2125

Robert A. Rees
Georgia Department of Natural Resources
Fisheries Section
Route 2, P.O. Box 219-R
Richmond Hill, Georgia 31324

James M. Smith
Tennessee Wildlife Resources Agency
Eagle Bend Fish Hatchery
1201 Moore Street
Clinton, Tennessee 37716

Theodore I. J. Smith
South Carolina Wildlife and Marine
Resources Department
Marine Resources Research Institute
P.O. Box 12559
Charleston, South Carolina 29412

Robert E. Stevens
U.S. Fish and Wildlife Service
Department of Interior
18th and C Streets, NW
Washington, DC 20240

Gregory L. Summers
Oklahoma Department of Wildlife
Conservation
Fisheries Research Laboratory
500E Constellation
Norman, Oklahoma 73072

James E. Van Tassel
Maryland Department of Natural Resources
Tidewater Administration
P.O. Box 1136
Prince Frederick, Maryland 20678

Charles J. Turner
Alabama Department of Conservation
and Natural Resources
Game and Fish Division
64 N. Union Street
Montgomery, Alabama 36756

Harry J. Warren
Texas Parks and Wildlife Department
Dundee Fish Hatchery
Route 1
Electra, Texas 76360

Thomas L. Wellborn
Route 2, P.O. Box 149A
Florence, Alabama 35633

David K. Whitehurst
Virginia Game and Inland Fisheries
Commission
P.O. Box 11104
Richmond, Virginia 23230

John G. Woiwode
AquaMatrix, Incorporated
P.O. Box 2437
Jackson, Wyoming 83301

L. Curry Woods, III
University of Maryland System
Agricultural Experiment Station
Crane Aquaculture Facility
P.O. Box 1475
Baltimore, Maryland 21203

Charles M. Wooley
U.S. Fish and Wildlife Service
1405 South Harrison Road, Room 302
East Lansing, Michigan 48823

David M. Yeager
Florida Game and Fresh Water Fish
Commission
Route 1, P.O. Box 79F
Holt, Florida 32564

Contents

Page	
ix	Preface
xi	Acknowledgements
1	Chapter 1: History and Overview of Striped Bass Culture and Management
7	Chapter 2: Design Considerations for Striped Bass and Striped Bass Hybrid Hatching Facilities
17	Chapter 3: Design of Rearing Facilities for Striped Bass and Hybrid Striped Bass
29	Chapter 4: Collection, Transportation, and Handling of Striped Bass Brood Stock
43	Chapter 5: Artificial Spawning and Fry Production of Striped Bass and Hybrids
73	Chapter 6: Tank Spawning Methodology for the Production of Striped Bass
79	Chapter 7: Pond Fertilization and Zooplankton Management Techniques for Production of Fingerling Striped Bass and Hybrid Striped Bass
99	Chapter 8: Pond Culture of Phase I Striped Bass Fingerlings
121	Chapter 9: Production of Advanced Fingerling and Subadult Striped Bass and Striped Bass Hybrids in Earthen Ponds
141	Chapter 10: Intensive Culture Techniques for the Striped Bass and Its Hybrids
159	Chapter 11: Hybridization, Genetic Manipulation, and Gene Pool Conservation of Striped Bass
191	Chapter 12: Special Considerations in the Culture of Striped Bass and Striped Bass Hybrids
217	Chapter 13: Parasites and Diseases of Striped Bass and Hybrids
239	Chapter 14: Overview and Considerations for Management of Striped Bass and Striped Bass Hybrids
243	Chapter 15: The Culture of Striped Bass and Hybrids in Brackish Water

253	Chapter 16: Striped Bass and Striped Bass Hybrid Culture: The Next Twenty-Five Years
263	References
295	Appendix A
313	Appendix B

Preface

In 1976, the Striped Bass Committee of the Southern Division, American Fisheries Society, published *Guidelines for Striped Bass Culture* (Bonn et al. 1976). This manual first consolidated and documented information on successful techniques for culturing striped bass and hybrid striped bass. Even though there have been literature reviews and symposia since, there has been no comprehensive culture manual since the *Guidelines* book was published.

This publication represents the first major effort to update *Guidelines for Striped Bass Culture* or include the considerable advances that have been made in the last 14 years. While there are likely to be some repetitions, inconsistencies, and even contradictions in this manual, the reader must remember that the various chapters were prepared by a large number of authors who have had different experiences under different circumstances. Please remember also that all of the authors were invited to contribute, based on their extensive experience in the culture of striped bass and hybrid striped bass. Contradictions or inconsistencies do not necessarily mean that one author is wrong and that another is right; rather, they have different perspectives due to their different circumstances. As editors, we have tried to reduce these inconsistencies and contradictions where we believed it desirable to do so, but we could not, in good faith, eliminate them all without imposing our own biases to a greater degree than we are comfortable with. Likewise, we felt that information which is repeated in the various chapters merits emphasis; thus, repetitions remain.

The reader will quickly notice that the chapters are a blend between cookbook and scientific writing — this is by design. Our intention was to develop a manual that can be generally understood by the layman and, at the same time, provide background and references for those who wish to further pursue the ideas presented. We chose to use the standard English units of measurement (e.g., pounds, inches, gallons) where everyday language would dictate a better understanding. This approach was dictated by the duality of the intended audience. Where specific recommendations and procedures are derived from scientific literature, or English measurements were not readily translated into metrics, metric units were employed. Readers familiar with the literature published in the Proceedings of the Annual Southeastern Association of Fish and Wildlife Agencies, should notice that the date of publication is the actual date the proceedings became available, and it is the official publication date recognized by the American Fisheries Society editorial office.

In both the scientific and general literature there has always been confusion over which hybrid cross an author is discussing. Often the cross is not presented or it is not clear which parent is the female and which is the male. In this manual we have standardized the names of the F₁ striped bass hybrids that are commonly produced. We have followed the accepted procedure of listing the female of the cross first. These common names were adopted by the Striped Bass Committee at its winter meeting in 1988: original hybrid (striped bass x white bass) — palmetto bass; reciprocal hybrid (white bass x striped bass) — sunshine bass; white perch hybrid

(striped bass x white perch) — Virginia bass; reciprocal white perch hybrid (white perch x striped bass) — Maryland bass; and striped bass x yellow bass — paradise bass. More detailed information about the crosses and descriptions can be found in Chapter 11. These names have been recognized by the American Fisheries Society Names of Fishes Committee, and will appear in the Fifth Edition of *Common and Scientific Names of Fishes* (Robins et al. 1991).

Finally, it is important to note that this manual has undergone considerable peer review; not only by the authors of the chapters, but by selected individuals whose research and experiences provided considerable insight to the development of the final product. We, the editors, are deeply indebted to all who contributed to the realization of this manual.

Reginal M. Harrell
Jerome Howard Kerby
R. Vernon Minton
May 1990

Acknowledgements

This manual is the result of cooperation, assistance, and a great deal of effort on the part of many individuals. We thank those individuals who critically reviewed the various chapters, especially Gary Carmichael, Ray Simon, and Ray Morgan for their valuable comments on Chapter 11 and Paul Eschmeyer for his invaluable editorial comments on numerous chapters. Special thanks are extended to the authors, Committee members (especially Chuck Starling), and the American Fisheries Society editorial office (in particular, Robert Kendall and Sally Kendall) for their critical review of the entire document.

We particularly want to thank the following individuals for their contributions: Joyce Mann, Lora McKenzie, and Violet Catrow of the National Fisheries Center-Leetown for their painstaking review and verification of most of the reference section; and Deborah Weber, Maryland Sea Grant Extension Program, University of Maryland Cooperative Extension Service, and Susan Barger, National Fisheries Center-Leetown, for their tireless efforts in proofing and typing the various corrections to this manual. Our gratitude is extended to Merrill Leffler and Sandy Harpe of the University of Maryland Sea Grant College Program for their efforts in preparing the final draft and artwork for publication.

The Striped Bass Technical Committee, the authors, and the editors are deeply indebted to the talents and graciousness of Mr. Duane Raver for contributing his artistic creation for the cover.

Publication of this manual would not have been possible without the financial support of private, state, and federal agencies. We would like to extend our deepest appreciation and thanks to the following contributors:

The United States Fish and Wildlife Service
Alabama Department of Conservation and Natural Resources
Arkansas Game and Fish Commission
Baltimore Gas and Electric Company
Duke Power Company
Florida Game and Fresh Water Fish Commission
Kentucky Department of Fish and Wildlife
Louisiana Department of Wildlife and Fisheries
Maryland Department of Agriculture
Maryland Department of Natural Resources
Mississippi Department of Wildlife Fisheries and Parks
Missouri Department of Conservation
North Carolina Wildlife Resources Commission
Oklahoma Department of Wildlife Conservation
South Carolina Wildlife and Marine Resources Department

xii • *Acknowledgements*

Texas Department of Parks and Wildlife

University of Maryland System:

 Horn Point Environmental Laboratories

 Maryland Cooperative Extension Service

 Maryland Sea Grant College Program

Virginia Commission of Game and Inland Fisheries

West Virginia Department of Natural Resources

History and Overview of Striped Bass Culture and Management

David K. Whitehurst and Robert E. Stevens

The striped bass, *Morone saxatilis* (Walbaum), is a member of the family Moronidae (Johnson 1984), which consists of both freshwater and anadromous species. The family is represented in North America by four species within the genus *Morone*. The striped bass is the largest and longest-lived of the species within the group. It has been known to live for 35 years and to attain weights exceeding 100 pounds (Smith 1907, as cited by Raney et al. 1952), although such weights have not been reported in recent years.

The original range of the striped bass was from the St. Lawrence River in Canada to northern Florida, and along the Gulf coast from western Florida to Louisiana (Raney et al. 1952). Distribution included nearshore waters, bays, and coastal rivers.

Historical Background

Striped bass have long been utilized as food, and more recently as a superb sport fish and commercially cultured product. The Massachusetts Bay Colony passed the first legislation in Colonial America to protect a fish species in 1639, when the use of striped bass as fertilizer was prohibited. A tax was levied on the striped bass fishery in 1670 that partially funded the establishment of the first public schools in the New World (Setzler et al. 1980). Anthropogenic effects on this species in terms of excessive harvest, destruction of habitat, and pollution have been discussed in literature for more than 100 years (Worth 1884; Raney et al. 1952; Mansueti 1962; Coutant 1985a; Goodyear 1985; Price et al. 1985). In recent years, anthropogenic influences have likely been responsible for dramatic declines in several of the largest coastal populations, most notably Chesapeake Bay and Albemarle Sound (Mehrle et al. 1982).

Striped bass have been considered desirable for transfer to other areas since they were first successfully introduced to the Pacific coast. In 1879 and 1881, 435 yearling fish were seined from the Navesink and Shrewsbury Rivers in New Jersey, transported across the country by train, and released in San Francisco Bay. Within 10 years, an important fishery had developed in central California (Raney et al. 1952). This population subsequently expanded from southern California to the Columbia River in Oregon.

Early Cultural Efforts

Striped bass culture began on the banks of the Roanoke River at Weldon, North Carolina, in 1884 at a hatchery constructed by the U. S. Fish Commission (Worth 1884). Eggs were incubated in standard MacDonald jars, which were widely used along the Atlantic Coast for culturing American shad (*Alosa sapidissima*) eggs. Ripe brood fish were caught by fishermen using skim nets in small boats and from fish traps in the falls at Weldon. Fish were transported to the hatchery where eggs were taken, fertilized, and placed in hatching jars. During the first year of operation, 2.4 million eggs were collected, 298,000 fry were hatched, and 280,500 fry were stocked into the Roanoke River (Worth 1884). This hatchery has been in operation almost continuously, first by Federal fisheries agencies, and later by the North Carolina Wildlife Resources Commission. Until the late 1960s, fry produced at Weldon were used almost exclusively to stock the Roanoke and other coastal rivers in North Carolina.

Several subsequent attempts to artificially propagate striped bass in Maryland and California failed in the early 1890s. In 1937, fry produced at Weldon were successfully reared to small fingerlings in earthen ponds at the Edenton National Fish Hatchery, North Carolina (Raney et al. 1952).

Early Freshwater Experiences

The first introduction of striped bass into freshwater impoundments occurred in New Jersey during the mid-1930s. The New Jersey Department of Conservation and Economic Development stocked young striped bass in a number of impoundments in the southern portions of the State; however, few striped bass were caught in these lakes (Surber 1958). Efforts to establish striped bass populations in freshwater impoundments continued into the early 1950s with little to no success.

Santee-Cooper

In 1941, the Santee-Cooper Reservoir system was created by the construction of a hydroelectric dam on the Cooper River, South Carolina. The dam impounded 160,000 acres of water and inundated portions of the Cooper and Santee Rivers which had historically supported populations of striped bass. By 1949, a large population of small striped bass was present, and by 1952 a sport fishery was established. Scruggs and Fuller (1954) determined the population was land-locked. The Wateree and Congaree Rivers above the system provided spawning grounds for the species, and conditions within the reservoirs were suitable for survival and growth. During the next 5 years, the population increased rapidly and produced one of the largest populations of striped bass per volume of water ever observed (Stevens 1958).

Kerr Reservoir

As the striped bass population was developing in the Santee-Cooper system, another impoundment was being constructed on the Roanoke River, along the North Carolina-Virginia border. Kerr Reservoir, a 48,900-acre impoundment, was completed in 1952. From 1953-1955, the North Carolina Wildlife Resources Commission stocked 3 million striped bass fry from its

Weldon Hatchery (Surber 1958). By the late 1950s a successful striped bass fishery had developed. Whether the fishery developed from the larval introductions or successful reproduction of landlocked fish is unclear, but the latter is considered more likely. The Roanoke and Dan Rivers entering the reservoir provided adequate spawning grounds, and successful reproduction was documented by the late 1950s (Neal 1969, 1971; Whitehurst and Carwile 1982). A major sport fishery developed, and the Virginia Department of Game and Inland Fisheries established a striped bass hatchery at Brookneal, Virginia, in the early 1960s.

Recognition of Management Potential

Development of landlocked populations of striped bass created intense interest by sport anglers and fishery biologists. However, biologists were concerned with the potential impacts of striped bass on native fish populations in reservoirs. Fortunately, studies by the South Carolina Department of Wildlife and Marine Resources (Stevens 1958) and the Virginia Department of Game and Inland Fisheries (Neal 1969) indicated that negative interactions with native fish communities would be minimal. These studies further suggested promise for striped bass as a sport fish and for biological control of gizzard shad (*Dorosoma cepedianum*). By the mid-1950s, inland fisheries agencies in southern states were cognizant of the potential these fish represented, and interest in establishing the species in reservoirs increased considerably. By the early 1960s, most of these fisheries agencies had embarked on programs to establish striped bass fisheries in their inland waters.

Renewed Interest in Culture and Significant Breakthroughs

Early attempts to establish striped bass populations were seriously hampered by unavailability of sufficient numbers of striped bass for stocking. In the 1960s, this problem was addressed individually by southeastern state fisheries agencies and the U.S. Fish and Wildlife Service, and collectively through the Reservoir Committee (Striped Bass Subcommittee), Southern Division, American Fisheries Society.

Development of a satisfactory technique for hormone-induced spawning by Stevens and his co-workers (Stevens et al. 1965; Stevens 1966, 1967) represented a major breakthrough in striped bass culture. This work was accomplished at the Moncks Corner, South Carolina, Striped Bass Hatchery where the first hatchery non-ripe females were successfully spawned. The techniques later refined by Bayless (1972) enabled production of over 100 million fry per year and stimulated the construction of additional striped bass hatcheries in the United States.

In initial attempts to establish inland striped bass populations, larval striped bass were introduced directly into reservoirs; however, these introductions were usually not successful. As a result, pond culture methods were explored as a means of producing fingerling striped bass (1-2 inches) to improve survival after reservoir stocking. After several years of cooperative efforts by state and federal agencies (coordinated by the Striped Bass Committee) and intensive studies at the Edenton National Fish Hatchery, successful pond culture techniques were developed (Regan et al. 1968; Bowker et al. 1969; Ray and Wirtanen 1970; Wirtanen and Ray 1971;

Braschler 1975; Bonn et al. 1976). By the early 1970s, production facilities were sufficient to produce adequate numbers of fingerlings for stocking the larger reservoirs in most southern states.

Inland striped bass programs grew rapidly following the development of culture methodologies and facilities, and seven striped bass fisheries had been established in impoundments by 1970, and 23 by 1973 (Bailey 1975). By 1981, striped bass fisheries were established in 100 lakes and reservoirs with a total area slightly greater than 2.4 million acres, while hybrid striped bass fisheries were present in 179 impoundments (Axon and Whitehurst 1985). Inland striped bass and hybrid programs increased from two established fisheries, which totaled 210,000 acres in the mid-1950s, to 279 lakes (3,953,600 acres) in 1981. Crude estimates indicated these fisheries were yielding annual recreational harvests of over 5.5 million pounds of striped bass and hybrids by 1981.

Coastal Considerations

Although enhancement stocking of striped bass fingerlings in some southern estuaries has been practiced for almost 20 years, interest in this management practice has expanded tremendously since 1980. This interest coincided with the precipitous decline of striped bass in several major estuaries on both coasts. Enhancement efforts are currently underway in the Chesapeake Bay, Delaware Bay, Albemarle Sound, Gulf of Mexico, San Francisco Bay, and the Hudson River in New York (as mitigation for power plant operations).

As the large-scale coastal stock enhancement programs are projected to extend through the 1990s in Chesapeake Bay, Hudson River, and San Francisco Bay. By that time, hundreds of thousands of phase II (ca. 3-10 inches long) fingerlings will be marked with binary coded wire tags and stocked in each system. Subsequent recapture efforts should demonstrate the efficacy of these coastal enhancement efforts by the end of the decade.

Formation and History of the Striped Bass Committee

The interest in developing striped bass populations in freshwater impoundments stimulated the formation of a Striped Bass Subcommittee within the Reservoir Committee of the Southern Division, American Fisheries Society. An organizational meeting of the subcommittee was held July 18, 1967, in Atlanta, Georgia. Representatives from eleven states and two federal agencies were present. The Striped Bass Subcommittee was elevated to full technical committee status in 1970.

The committee's purpose was defined in a resolution presented to the Southern Division of the American Fisheries Society as: ". . . the Striped Bass Committee goes on record as being interested in all phases of hatching, rearing, stocking, and management of striped bass and hybrids thereof in suitable environments." Since its formation, the Committee has expanded to encompass virtually all aspects of the biology, culture, and management of striped bass in inland and coastal waters. The Committee has played a significant role in the success of culture and management efforts over the years and has been especially valuable in providing an open

forum for the exchange of information among agencies and companies working with this fish. A major accomplishment of the Committee was publication of the original *Guidelines for Striped Bass Culture* (Bonn et al. 1976). The primary objective of this endeavor was to consolidate and document information on successful techniques for culturing striped bass and hybrids and to provide a frame of reference for refining culture procedures.

Design Considerations for Striped Bass and Striped Bass Hybrid Hatching Facilities

Anthony W. Mullis and James M. Smith

Site selection is a critical initial step in the establishment of any hatchery, and the site for a proposed striped bass (*Morone saxatilis*) and hybrid fry production facility must be carefully evaluated to assure that critical needs are met. Proximity of the brood fish collection site to the fingerling rearing facility is highly desirable, although not essential. Site consideration should emphasize reduction of stress to fry or brood fish through reduced handling and transport, which will result in improved survival rates. Other factors to consider in site location include accessibility by support vehicles, hatchery staff and, if a government-operated facility, convenient access by the public for educational purposes. A practical means of excluding the public from dangerous or high-activity work areas may be desirable. An egg collection and hatching facility does not require a great deal of land area, but it does require a dependable supply of high quality water in large volumes.

Water Supply

It is not a trivial statement to say that water is one of the most important keys to the propagation and culture of striped bass. Not only is the quantity of water important but so is the quality. We will discuss the important characteristics that should be considered in selecting a site for locating a striped bass hatchery.

Water Source

Hatchery water sources may consist of surface water (streams or impoundments), or wells tapping underground water-bearing strata. Surface waters often carry a high load of suspended solids and exhibit widely fluctuating temperatures, particularly during the spring spawning period. Water levels of surface sources may also fluctuate, creating problems with the placement of withdrawal structures. However, surface waters are generally inexpensive water sources if impoundments are not constructed specifically for hatchery purposes.

Underground water sources are usually characterized by constant water flow with low temperatures, and often provide good water quality. Expensive temperature control, filtration, and water quality improvement systems are usually not required when water is supplied via wells. However, some subsurface water sources are high in dissolved solids or gases or have other poor water quality characteristics, such as very low alkalinity, which render the water unsuitable for hatchery use without prior treatment. Wells large enough to provide the volume of water necessary for egg hatching are very expensive to install.

Whatever the source, water may be withdrawn and transported to the hatchery by pump and enclosed pipes, or by gravity flow in pipes or open flumes. Obviously, the hatchery must be situated at a lower elevation in proximity to the water source for a gravity-flow water system to be used. If an underground water source, or a surface source that is lower in elevation than the hatchery, is used, the water must be pumped to the hatchery.

Generally, water is pumped into a head tank and then supplied to the hatchery by gravity flow. Systems using pumps are more expensive, and the potential for loss of eggs or fry is greater due to possible mechanical failure of the pump or power supply. Location of the pump and withdrawal structure on a water supply with a fluctuating surface may also present difficulties. Changes in the surface level of a lentic water source (i.e., lake) can affect the depth of the thermocline, which can result in pumping anoxic water through a stationary intake. Severe declines in water level can also leave stationary intakes exposed.

The pump horsepower (hp) required to lift water at a specific rate in gallons per minute (gpm) to a specific height (total head), assuming 100% efficiency, may be calculated using the following formula (Berkeley Pump Company 1965):

$$\text{hp} = \frac{\text{gpm} \times \text{total head (feet)}}{3,960}$$

Pumps vary greatly in their efficiency, but no pump is 100% efficient; therefore, the horsepower calculation must be adjusted by dividing by the percent pump efficiency. As a fluid flows through a piping system, it will experience a pressure loss depending on fluid velocity, pipe wall smoothness, internal surface area of the pipe, and total length of pipe. This pressure (head) loss is calculated using a modification of the Williams and Hazen formula (King 1967):

$$H = 0.2083 (100/c)^{1.852} \times (q^{1.852} / d^{4.8655})$$

Where H = friction head in feet of water per hundred feet of pipe
 q = flow (gpm)
 d = internal diameter of pipe (inches)
 c = surface roughness constant of the pipe (150 for thermoplastic pipe; available from pipe dealers for other kinds of pipe)

The friction head must be added to the total head in calculating pump horsepower. Fittings and valves, due to their more complex internal configuration, are also a significant factor in friction losses in a piping system. This loss is expressed as the length of pipe required to give the same friction loss as the same size fitting or valve. Equivalent pipe lengths for various fittings and valves may be obtained from piping handbooks or reference books.

Water Quality

The water quality parameter measurements recommended for striped bass/hybrid fry production are listed in Table 2.1.

Physical Requirements

General

A striped bass or hybrid striped bass fry production facility must include areas and equipment for processing brood fish. Brood fish may be held prior to spawning in permanent concrete or fiberglass tanks, raceways, or in circular tanks which can be easily arranged or removed when not needed. Holding facilities should be supplied with a steady flow of fresh or low salinity, well-oxygenated water at a constant temperature to control wastes and keep brood fish in good condition. They should be fitted with removable or external stand pipes at the drain to facilitate cleaning. A means of separating males from females and confining individual female brood fish in separate compartments is necessary for efficient spawning procedures. When spawning fish in tanks, additional holding facilities are not needed, except to hold extra male fish (see Chapter 6). Equipment for handling brood fish, such as dip nets, seines, and anesthetizing tanks should be maintained and readily available in the area.

A dry laboratory area should be close to the brood fish holding area for egg staging and hormone preparation. It should be equipped with a stereo-dissecting microscope with the proper light sources, catheter tubes, microscope slides and cover glasses, an accurate balance, and a supply of 3- and 5-cc (cubic centimeters) syringes (see Chapter 5 for uses). Other equipment and supplies which should be available include watch glasses, Petri dishes, various suction pipettes, 0.25 and 0.5-inch glass tubes for collecting water-hardened egg samples, hatchery record forms, pencils, measuring boards, and rulers. A separate chemical storage area should be maintained near this area.

Spawning and incubation of eggs are conducted in a production area, which should be located near (or adjacent to) the brood fish holding area. Tanks should be supplied with a forced air supply to provide water aeration, and bubble curtains to prevent egg chorions and dead eggs from clogging standpipe screens. A high-volume, low-pressure regenerative blower (without carbon vanes) will serve the needs of most hatcheries for forced air. The air can be transported by a system of 2- to 3-inch inside diameter (ID), schedule 40 polyvinyl chloride (PVC) pipe with droppers from "T" fittings reduced to 0.5 inch. The droppers should be fitted with adjustable valves to which 1/8-inch ID clear plastic airline is attached.

The hatchery facility should include an equipment storage and repair area, as well as office space with a desk, typewriter, calculator, and record-keeping facilities. Striped bass and

hybrid fry production require a 24-hour vigil on imminently spawning fish and incubating eggs, so living quarters for the hatchery staff should also be provided. Living quarters should include sleeping and toilet facilities, food storage and preparation area and facilities, and lounging area for off-duty staff.

Jar Culture Facilities

A production facility designed for incubating eggs in hatching jars requires a brood fish holding area, a spawning area, and a jar incubation area, all in close proximity. The spawning area must be equipped with a sturdy, well-drained, corrosion-resistant spawning table, with a readily available supply of fresh water from the same source as the incubation water. This table should be located near the anesthetizing tank so it can be used during egg stripping and as a platform for holding pans of eggs during fertilization, as described by Bayless (1972); it should be about 39 inches high.

As previously noted, incubation water should be stored in an elevated, constant level head tank and supplied to the incubating eggs by gravity flow to minimize pressure changes. The capacity of the head tank should be at least 1,000 gallons; however, it is recommended that the capacity be 2,000-3,000 gallons or more to provide a greater emergency water reserve in the event of pump or mechanical failure. Water is transported to the incubation area in PVC pipe. Water is supplied to individual jars through 0.5-inch ID rubber tubing into which an 18-inch length of 0.5-inch ID glass or plastic tube has been inserted.

Water temperature controls the hatching time and larval development rate (see Chapter 5). Suboptimal or rapidly changing temperatures can affect development and lead to low survival or malformation of fry. Therefore, temperature control of incubation water is essential, particularly if a surface water source is utilized. However, water heaters and chillers are expensive, and the costs of altering the temperature of the volume of water that passes through a hatching facility can be prohibitive.

Oxygen levels in the incubation water should be monitored regularly to assure that they conform to levels recommended in Table 2.1. Packed columns (Owsley 1981) can be used to provide additional aeration and to reduce the levels of ammonia, nitrogen, and other dissolved gases which may be at supersaturation levels in well or spring water. Waste incubation water is drained from the hatchery building through screened flumes or closed drainage pipes located under the building floor.

Jar incubation procedures commonly used for hatching striped bass and hybrid eggs are based on those originally described by Worth (1884). Hatching jars normally hold 1.8 gallons of water. MacDonald jars were the jars originally used for culture of striped bass, but now they are difficult to find. Midland Plastics, Inc. (Appendix B) makes a modified MacDonald jar (Figure 2.1) that is currently the standard used in striped bass culture. These plexiglass jars have a wider top, a broad base without the legs which were easily broken on the original MacDonald jars, and come with the "shad" tube (tube-within-a-tube) system that eliminates potential air bubble disturbance of the eggs.

Table 2.1. Water quality variable measurements recommended for striped bass and hybrid fry production. (Modified from Bonn et al. 1976.)

Variable ^a	Acceptable Range	Optimum
Temperature	58 - 75°F	62 - 65°F
pH	6.5 - 9.0	7.5 - 8.5
Dissolved oxygen	4 - 10	saturation
Total Hardness		200 - 250
Dissolved Nitrogen		< saturation
Salinity		0 - 5
Nitrates		<2.0
Nitrites		<0.2
Ammonia (un-ionized) ^b		<0.02
Carbon dioxide		<10.0
Copper		<0.1
Hydrogen sulphide		<0.3
Phosphates		<6.0
Potassium		<2.0
Sodium		<5.0
Zinc		<0.1
Iron		<0.5

^a Unless otherwise noted all measurements are ppm; pH is in pH units, and salinity is ppt.

^b At constant temperature, the concentration of total ammonia that contains 0.02 ppm of unionized ammonia (toxic) decreases as pH increases (U.S. Environmental Protection Agency 1976).

Water is fed through the 0.5-inch ID glass or plastic tubing described previously, which is placed inside the shad tube close to the bottom of the jar (Figure 2.1). Fins located at the base of the shad tube keep it positioned vertically. This design allows air bubbles to escape without washing eggs over the lip of the jar. Upwelling currents created by water inflow keep the eggs in constant suspension. Flow rates of about 0.5 gallon/minute per jar are required for the initial water hardening of striped bass eggs (see Chapter 5 for further details). MacDonald jars should be positioned to discharge into an aquarium, and the aquarium should be fitted with a drain standpipe equal in length to the desired water level. The drain standpipe should be surrounded by a stainless steel, perforated brass, or nylon screen cylinder which is slightly taller than the standpipe and which is completely sealed to the bottom of the aquarium or standpipe (Figure 2.2). The screen should be of sufficient diameter to provide 600 square inches per gallon per minute of water flow into the aquarium. Screening with approximately 500 μm openings will retain striped bass and palmetto bass (striped bass x white bass *M. chrysops*) fry. Mesh with 400 μm openings will retain sunshine bass (white bass x striped bass) fry, but 200 μm mesh will reduce impingement of fry on the screen (W. E. Jenkins, South Carolina Wildlife and Marine Resources Department, personal communication). A perforated air line, which can be made from 1/8-inch ID flexible plastic tubing, is attached around the base of the screen to provide a

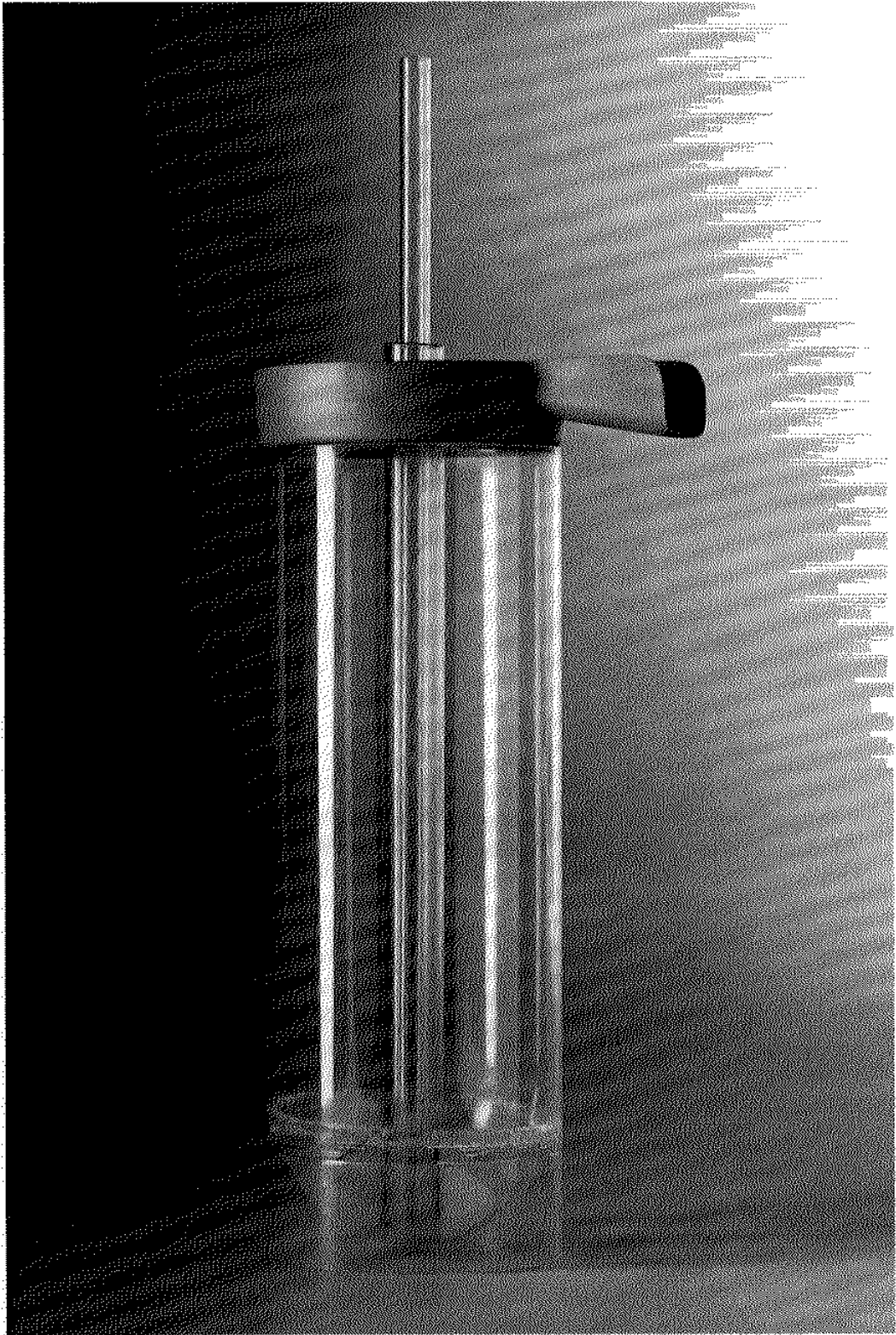

Figure 2.1. Modified MacDonal hatchling jar with tube-within-a-tube arrangement. Photo credit: North Carolina Wildlife Resources Commission.

bubble curtain to aerate the water and prevent fry or egg remains from clogging the screen. Water should be supplied at the rate of about 0.5 gallon/minute per 20-gallon aquarium.

Aquaria should be mounted on tables equipped with a central drain line into which the standpipes discharge (Figure 2.2). MacDonald jars are set on slightly raised (2.5 inches) platforms constructed parallel to the aquariums. The table can also be built with a recessed trough in which the aquaria fit, about 2.5 inches lower than the surface of the table. A working space of approximately 30 square feet of floor area is required per million eggs in incubation.

Tank Culture Facilities

A tank culture facility for striped bass must incorporate many of the same features as a jar culture facility; however, some features do differ. A minimum number of brood fish holding tanks are required because brood fish are maintained within the spawning tanks. No spawning area is required for producing striped bass fry, but if hybrids are to be produced, a spawning area similar to that for jar culture is necessary.

Water for tank culture is stored in a head tank and delivered to the spawning tanks by gravity flow through 0.5-inch ID PVC or glass tubes (Figure 2.3). Water clarity is recommended for tank spawning to prevent clogging of screens and to allow observation of spawning activity; therefore, water with a high load of suspended solids (particularly surface water) must be filtered before entering the spawning tanks. A large volume (525 gallons) sand and gravel swimming pool filter will usually provide adequate filtration. Water temperature should remain constant, with the optimum temperature being in the range of 63-68°F (Table 2.1). Water can be warmed in the storage tank utilizing solar energy, or temperature can be manipulated inside the hatchery with heat exchangers. If water is heated, care must be taken that heating does not result in gas (especially nitrogen) supersaturation. Water must be supplied to each spawning tank at the rate of 3-10 gallons/minute. A maximum of three million eggs can be incubated in a 6 foot x 2 foot circular tank using 1-3 gallons/minute per million eggs.

Spawning tank layout can be designed to conform to an existing facility. Each spawning tank (assuming 6-foot diameter tanks) requires approximately 56 square feet of floor area including working space. The tanks should be located in an area of minimal activity and traffic to minimize disturbing spawning fish. Lighting should be overhead incandescent bulbs which can be extinguished or dimmed during periods of spawning activity.

Bishop (1975) recommended the use of 6-foot diameter circular fiberglass tanks as the most desirable size tank for striped bass spawning (Figure 2.3). He reported that approximately one million fry per tank could be produced per week (see Chapter 6 for specific production details). Each tank should be fitted with a center drain and removable standpipe. The standpipe can be of any height, but it should be at least 4 inches shorter than the depth of the tank. The standpipe should be enclosed within a circular screen 15-18 inches in diameter, with mesh openings of 500 μm . A screen frame can be constructed from 1.5-inch ID diameter PVC pipe (Figure 2.4) and covered with fine-mesh stainless steel screen, which can be obtained from a



Figure 2.2. Excluder screen (nylon) surrounding drain standpipe in aquarium. Photo credit: Monte Stuckey.



Figure 2.3. Circular spawning tank with screened standpipe. Photo credit: Tennessee Wildlife Resources Agency.

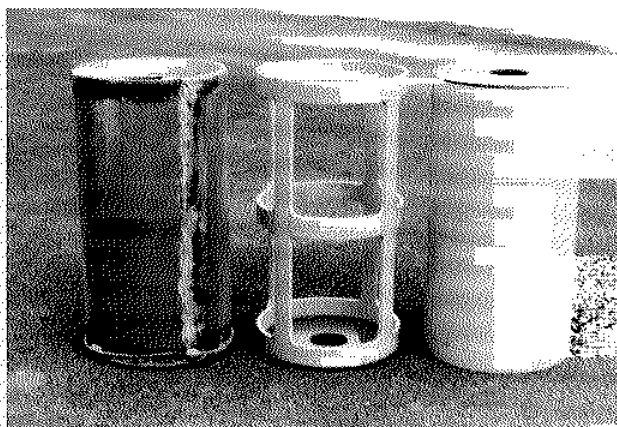

Figure 2.4. Construction of standpipe screen for circular tank made from 15 inch PVC pipe. Photo credit: Tennessee Wildlife Resources Agency.

paper mill. The screen must be completely sealed to the tank bottom to prevent fry from escaping. A perforated 1/8-inch ID plastic air line should be attached around the perimeter of the bottom of the screen to provide a bubble curtain that will help prevent fry and egg remains from clogging the screen. If they are not constructed with PVC legs or skirts, spawning tanks should be set on metal or wooden stands that can be leveled and allow drainage into a below-floor drain line. Movable crowding screens should be available to facilitate removal of brood fish and fry from the spawning tanks.

Portable Hatchery

Striped bass and hybrid fry production facilities utilizing jar or tank culture procedures may be designed for portability and temporary use. Portable facilities are generally established using surface water sources. The site is usually convenient to the spawning area, to reduce brood fish handling and transport stress. Water can be supplied to a jar facility directly from pumps through a manifold system or by gravity flow from a head tank to which the water has been pumped. The pump and manifold system is more portable, but it may cause supersaturation of dissolved gasses in the water, and constant water pressure to the jars is difficult to maintain. These problems are not usually encountered with a gravity flow system, but a gravity system is more difficult to relocate and is restricted to an area of suitable gradient. The pump system is recommended for tank facilities since constant water pressure in the lines is not critical. Dependence on a pump for water supply requires a backup pump and power supply in the event of equipment or electrical failure.

Design of Rearing Facilities for Striped Bass and Hybrid Striped Bass

Harry J. Warren, Reginal M. Harrell,
James G. Geiger, and Robert A. Rees

Site selection, sufficient water quantity and quality, and soil profiles are important factors to consider in the design of a striped bass (*Morone saxatilis*) rearing facility, whether it is an intensive indoor closed or flow-through facility, or a semi-intensive or extensive pond culture facility. The terrain should lend itself to minimal soil removal to minimize costs, soils should be such that they hold water, and there must be enough water in excess of normal needs to provide for emergency situations.

Design Considerations

Westers (1983) summarized the major criteria that should be considered in hatchery design:

1. Site selection (primarily in terms of water quality)
2. Water treatment (pre- and post-culture)
3. Pathogen control (sanitation, disinfection, quarantine)
4. Quality rearing environment (reducing stress)
5. Hatchery management and operation (closely tied to reducing stress).

Although Westers (1983) approached facility design from a perspective of disease prevention, the concept of providing a quality rearing environment that reduces environmental and biological stress on the target fish is extremely important for intensive and extensive culture operations. The objective of successful fish culture is to provide, at reasonable cost, large quantities of a high quality fish for use in management, restoration, or commercial purposes. This objective requires a rearing facility to be flexible in adapting to new species, techniques, and technologies, and, unfortunately, to finite amounts of water. In addition, reductions in water quality (and possibly quantity), and increases in environmental regulation of effluent discharge should be expected over the operational life of the facility.

It is not our intention here to design the ultimate rearing facility for the striped bass or its hybrids. Numerous available papers and books provide valuable information and reference points for ideal design (e.g., Lewis et al. 1981; Piper et al. 1982; Meyer et al. 1983; Dupree and Huner 1984; Stickney 1986; and others). Our primary objective is to highlight specific areas where new technologies and design options may allow more adaptability of facilities for increased production and efficiency. We also mention critical areas that should be addressed in any proposed renovation or new construction.

The recent Wallop-Breaux expansion of Sport Fish Restoration funding (originally Dingell-Johnson Act) has generated considerable new hatchery and rearing facility construction and renovation by many states. We highly recommend that fisheries administrators, managers, and engineering staffs visit as many of these modern facilities as possible to see firsthand what works, what does not, and how operational personnel view their facilities from the standpoint of efficiency, economy of operation, and maintenance requirements.

The primary concern in site selection must be the quality and quantity of groundwater (spring, well) and surface water supplies (stream, reservoir, river, city). Typical water quality standards for fish culture are listed in Table 3.1 (Daily and Economon 1983). The site selection for any facility should be based on thorough knowledge of local and regional hydrology, geology, weather, and climate (Piper et al. 1982). Design and operation should maximize the use of any gravity-flow, to reduce pumping except in emergencies.

Intensive Systems

Water quantity and quality. Consideration must be given to the type of facility desired. Intensive culture operations utilizing semi-closed or closed recirculating culture systems require substantial amounts of makeup water (Lewis et al. 1981; Piper et al. 1982; Stickney 1986). In many situations, where existing facilities are being renovated or converted for rearing new species requiring different temperatures, flows, or water quality, existing water sources may be only marginal.

Pre-treatment of water which may improve its chemical and physical characteristics and control possible pathogens sometimes involves several operations: oxygenation, degassing (to remove harmful levels of nitrogen, carbon dioxide, or other gasses), iron removal (by oxidation and precipitation), filtration (reduction in solids), temperature control (heating, chilling, blending), and pH modification by buffering (Westers 1983). If contamination of surface waters by pathogens is a possibility, disinfection by ultraviolet radiation (Legan 1982) or ozonation (Rosenthal and Kruner 1985) should be considered. New generation ultraviolet light sterilizers and ozonation equipment are more reliable and cost effective than earlier systems.

Design provisions should be made to add the necessary filtration, sterilization, or disinfection equipment to proposed rearing facilities. It is considerably more economical to adequately plan for future additions of space, and electrical, mechanical, and plumbing requirements rather than retrofit (if possible) the completed facility at a later date.

Table 3.1. Water quality standards for fish culture (adapted from Daily and Economon 1983).

Criterion	Standard
	(ppm) ^a
Alkalinity (hardness as CaCO ₃)	≥20.0
Aluminum (Al)	<0.01
Ammonia (NH ₃)	<0.02
Arsenic (As)	<0.05
Barium (Ba)	5.0
Cadmium (Alkalinity ≤100)	0.0005
(Alkalinity >100)	0.005
Calcium (Ca)	≥52.0
Chlorine (Cl)	<0.003
Chromium (Cr)	0.03
Carbon dioxide (CO ₂)	1.5 (not >15)
Copper (Alkalinity ≤100 ppm)	0.006
(Alkalinity >100 ppm)	0.03
Dissolved oxygen (DO)	75% of saturation, never <5.0
Fluoride (F)	<0.5
Hydrogen cyanide (HCN)	<0.005
Hydrogen sulfide (H ₂ S)	<0.003
Iron (Fe)	<0.1
Lead (Pb)	<0.02
Magnesium (Mg)	<15.0
Manganese (Mn)	<0.01
Mercury (Hg)	<0.2
Nitrogen (N)	<103% nitrogen gas
Total gas pressure	<110% total gas
Nitrate (NO ₃)	<1.0
Nitrite (NO ₂)	<1.0
Nickel (Ni)	<0.01
PCB	0.002
pH	6.7 - 8.6
Potassium (K)	<5.0
Salinity	<5.0 ^a
Selenium (Se)	<0.01
Silver (Ag)	<0.003
Sodium (Na)	<75.0
Sulfur (S)	<1.0
Sulphate (SO ₄)	<50.0
Total Dissolved Solids (TDS)	<400.0
Total Suspended Solids (TSS)	<80.0
Uranium (U)	<0.1
Vanadium (V)	<0.1
Zinc (Zn)	0.005
Zirconium (Z)	0.1

^a Exceptions: standard for salinity is in parts per thousand; pH is in pH units.

Contaminants. Pesticides and other contaminants may be present in ground and surface water sources. It is prudent to analyze proposed water sources for nutrients, pesticides, and herbicides by using EPA approved techniques before committing resources for design and construction. Johnson and Finley (1980) provided information on toxicities of numerous compounds to fish and aquatic invertebrates important in fish culture operations.

Heating and chilling. Successful intensive rearing of striped bass and their hybrids will inevitably involve heating or chilling water for various life history stages. Heating can be controlled by a variety of methods, including heat exchangers (column or flat plate) in combination with oil, natural gas, or propane-fired boilers; water-to-water heat pumps (Fuss 1983); and immersible electric heaters. Care must be taken that any in-line heating system be constructed of non-toxic materials (stainless steel in fresh water or titanium in saltwater) and that materials containing copper be avoided. At least one agency has experimented with the economic and technical feasibility of using salt-gradient solar ponds to produce heat and generate electricity (Siegel et al. 1985). Other cost-effective options for supplemental heating of water may include practical use of waste heat from continuously operated mechanical equipment, such as low pressure/high volume air blowers.

Economic considerations. Efficient, cost effective, rearing facilities are mandatory in the fuel conscious 1990s and beyond. We highly recommend that the biological field staff, administrative staff, and in-house or outside architectural and engineering staffs be involved with all aspects of conceptual design of the facility, and that options be developed for critical selection or rejection on the basis of biological and economic considerations.

In intensive systems, serious consideration should be given to reconditioning and reuse of up to 90% or more of the rearing water by recycling it through mechanical and biological filters (to remove suspended solids and accumulated waste products), heat exchangers or chillers (to re-establish optimum temperature regimes), and disinfection or sterilization systems to remove pathogens (Piper et al. 1982).

The final step in this process is to reoxygenate the water. New technology centered on packed columns (Colt and Bouck 1984), in combination with the use of liquid or gaseous oxygen, has proven effective for simultaneously increasing dissolved oxygen levels and removing excess nitrogen from the water. Supersaturating water with oxygen increases fish rearing capacity per unit volume of water; thus, if significant quantities of water must be heated or chilled, the amount of water can be significantly reduced (Visscher and Godby 1987).

Even if economic considerations do not allow the implementation of a full reuse system, we recommend that adequate water supply and drain lines, appropriate valves, and required electrical and mechanical systems be included during initial facility design to allow increased reuse capability later. In facilities with reuse and open (pond) culture facilities, good quality water discharged from the reuse rearing units can be used for semi-intensive pond culture operations. Initial settling of solids, disinfection, and aeration may be required to ensure good water quality and to prevent introducing unwanted or undesirable "variables" into pond pro-

duction. Although the considerations mentioned above are primarily intended for intensive indoor systems, application could be beneficial in semi-intensive pond culture. However, the economic cost-benefit ratios should be evaluated before implementation.

Site Selection: Open Systems

Semi-intensive and extensive culture operations employing large numbers of ponds must have water available to offset leakage and evaporation. There must also be sufficient amounts of water to allow for inflows into ponds during periods of high temperature, low dissolved oxygen concentrations, or harvesting. In general, we recommend that the facility have a minimum of 50 gallons per minute per surface acre to adequately meet the projected needs of pond production.

Site Location

Topography determines not only the amount of soil that will be moved during pond construction, but also the size and configuration of resulting ponds. If possible, ponds should have similar sizes, shapes, and orientation (Figure 3.1). Pond construction costs (movement of cubic yards of soil) are lower on flat terrain than on terrain with relief (Jensen 1988). Practical site location ensures that ponds can be completely drained by gravity during any time of the year, and that the selected location is not subject to flooding and runoff. Suitable commercial electrical power (three-phase is the more cost effective) and telephone access should be available (Jensen 1988). Because of increasing regulations pertaining to effluent, one or more settling ponds equipped with electrical power and aeration systems should be provided to allow removal of settling solids and to allow oxidation of chemical treatments before discharge.

Soil types and the underlying strata must be considered in site selection and design. Geotechnical investigations are extremely beneficial to evaluate subsurface conditions of a proposed site, and the impact of any proposed improvements on these conditions. Soils composed of loose, wet, silts and sands typically have low shear strength and high compressibility, which can adversely affect berm design, short-term stability, and long-term settlement. A competent geotechnical investigation provides valuable information that can be used to accept or reject a site, and to make informed management decisions about costs of construction.

Pond Liners

Natural liners. If soils do not contain enough clay, seepage losses can be reduced by using natural (clay) lining materials or synthetic liners. A clay blanket should contain at least 23% clay. The thickness of the natural liner will depend on the depth of water in the pond, and the frequency of pond filling and draining (U.S. Department of Agriculture 1973).

The addition of bentonite is another method of reducing excessive seepage in soils containing high percentages of coarse-grained particles and insufficient clay. Bentonite is a fine-textured colloidal clay that swells as much as 8 to 20 times its original volume when wet. Ponds sealed with excessive amounts of bentonite sometimes crack as they dry, increasing the danger of seepage (U.S. Department of Agriculture 1973).

Synthetic liners. Acceptable synthetic liners (Figure 3.2) include high density polyethylene, 40-60 mils thick, and hypalon (chlorosulfonated polyethylene), 36-45 mils thick. Thicker liners offer increased durability and resistance to puncture. Both types of liners are resistant to ultraviolet light and are generally easy to install.

All types of synthetic liners require a smooth, uniform subgrade free of exposed rock and rock fragments to protect the liner and to minimize installation costs. A minimum thickness of 4 inches of bedding material (clay, silt, or sand material free of stones, rock, etc.) is recommended.

A perimeter gas venting system must be provided to release any gas buildup under the liner from the decomposition of underlying organic material. A subgrade drain system may also be necessary if high ground water conditions are present. Liners must be properly anchored to earthen berms and any concrete harvest structures.

Synthetic liners control seepage, provide a uniform pond environment, reduce or eliminate rooted aquatic vegetation, enhance pond draining and maintenance, and can enhance solar thermal gain. Their major disadvantage is cost. However, many state and federal hatchery systems are installing synthetic pond liners with excellent results.

Pond Design

Ideally pond design for production of striped bass and striped bass hybrids should include the following criteria:

- (1) We recommend that ponds for fingerling culture should be 0.5 to 1.0 surface acre, with a minimum depth of 2.5 feet at the shallow end and 6 feet at the deep end. If the soils will compact properly, berms should have 2.5 to 3.0:1 maximum side slopes to reduce earthwork. There should be about 2 feet of freeboard from the operational water level to the top of the berm.
- (2) Design should emphasize uniformity regarding pond size, shape, solar orientation, and wind direction. Such uniformity should reduce the number of variables that influence fish production and variability between ponds. Irregular pond shapes should be avoided, if possible.
- (3) Water distribution systems should supply both the shallow and deep ends of the pond to allow water to be introduced from either end. This will help more rapidly and effectively improve water quality during critical culture phases.
- (4) Drainage systems should be centrally located to reduce piping; settling ponds will allow for water quality improvement before discharge.
- (5) It is highly desirable to be able to fill and drain a pond within 24 hours. The pipe size of fill and drain lines will depend on the size and number of ponds to be simultaneously filled

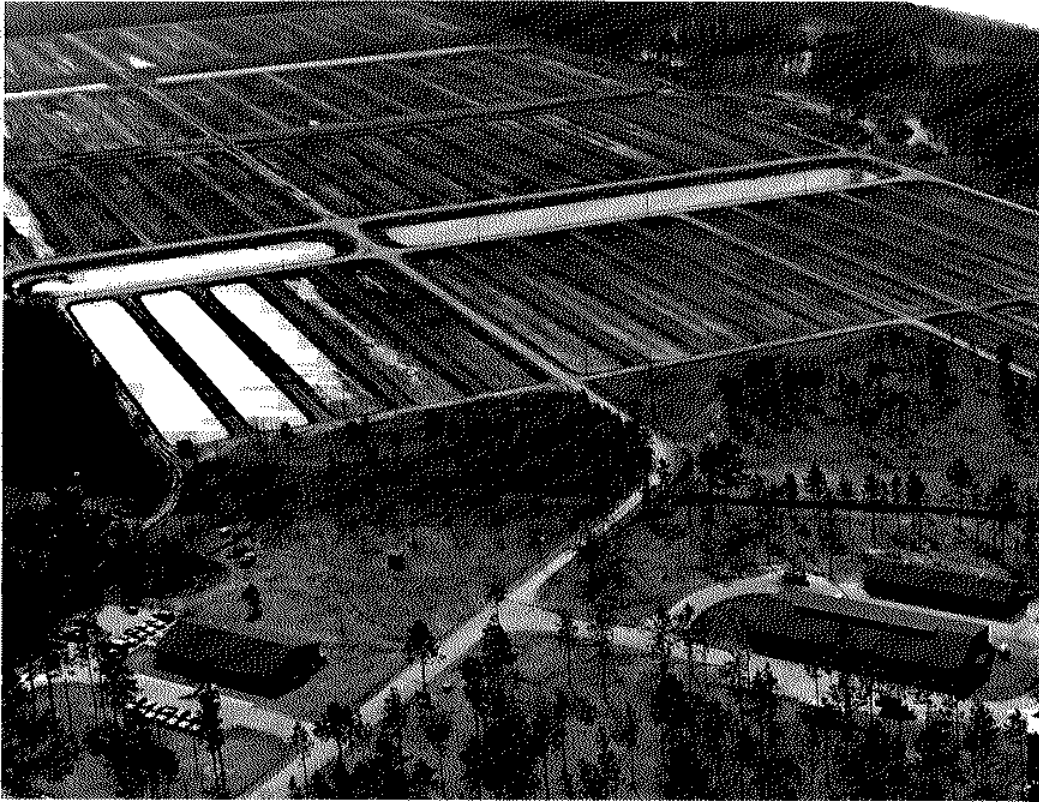

Figure 3.1. Pond design and lay-out for semi-intensive fingerling striped bass and hybrids striped bass ponds. Note pond orientation and common berms to minimize costs. Photo Credit: South Carolina Wildlife and Marine Resources Department.



Figure 3.2. Synthetic pond liner in fingerling production pond. Photo Credit: Texas Parks and Wildlife Department.

Table 3.2. Water flow rates equivalent to acre-feet of water per day^a (from Jensen 1988).

Flow rate (Gal/min)	Acre-feet/day ^b	Flow rate (Gal/min)	Acre-feet/day ^b
50	0.22	1,000	4.42
100	0.44	1,500	6.63
200	0.88	2,000	8.84
300	1.33	2,500	11.05
400	1.77	3,000	13.26
500	2.21	4,000	17.68
750	3.31	5,000	22.09

^a Values are not corrected for precipitation, evaporation, and seepage.

^b To determine filling time for a pond, divide the estimated total acre-feet of water in the pond by continuous pumping rate in acre-feet per day.

Table 3.3. Estimated pond filling time in days at different pumping rates (from Jensen 1988)^a.

Pond size (acres)	Pumping rate (gpm)					
	200	500	1,000	1,500	2,000	3,000
1	4.5	1.8	0.9	0.6	0.5	0.3
2	9.0	3.6	1.8	1.2	0.9	0.6
5	23.0	9.0	4.5	3.0	2.3	1.5
10	45.0	18.0	9.0	6.0	4.5	3.0
20	90.0	36.0	18.0	12.0	9.0	6.0

^a Average water depth of 4 feet is assumed. Values do not include losses or gains from rainfall, seepage or evaporation.

and drained. Design must consider the operational labor required during filling and draining procedures. Tables 3.2 and 3.3 provide water flow rates necessary to fill a specific pond volume per day, and estimated filling time in days at different pumping rates (Jensen 1988).

(6) Concrete harvest kettles (catch basins) allow fish to be rapidly collected and removed during harvest, thus reducing stress and improving quality of fish. Harvest kettles should be equipped with steps and walkways to improve harvest operations. Dam boards, gate valves, and butterfly valves are commonly used to adjust and regulate water flows through harvest kettles. Dam boards in combination with a perforated screen and an adjustable foot-valve behind the screen will not clog, and thus provide a safe means of regulating water flow (Figure 3.3). Recent kettle design incorporates a built-in raceway with its own continuous flow of fresh water and drain (Figure 3.4). As the pond is drained, fish are collected in the raceway section. Additional features, such as availability of 110- and 208-v electrical service and low pressure air lines, allow the culturist to maintain optimum water quality, dissolved oxygen, and temperatures, during critical harvest operations. In addition, electrical power at the harvest kettles allow use of emergency aerators, automatic feeders, pumps, lights, and balances.

(7) All-weather access roads with gravel surfaces should be constructed between ponds on the harvest kettle sides to allow vehicular access to the harvest structures for applications of fertilizers, chemicals, and feed, fish harvesting, and general maintenance.

(8) Individual pond kettle structures also offer the opportunity to install remote data acquisition features, such as sensors for dissolved oxygen, temperature, water depth (with high and low level alarms), and drain and fill valve controls. Signals can be transmitted by burial of shielded cable to a central remote terminal unit. Suitable numbers of cable pairs can be laid in trenches with existing low pressure air or water lines. At some later point, sensors and remote terminal units can be installed relatively easily and interfaced to the main facility microcomputer.

Support Facilities

A separate feed storage area is recommended for dry feed. This building should be easily accessible, and have wide double doors on each end for loading, unloading, or drive-through. Feed storage buildings should be air-conditioned, vermin-proof, and have concrete floors with recessed, centered drains for cleaning. If moist pellets are used, a cold storage facility with the capability of maintaining 10°F and the capacity to hold a 60- to 90-day food supply is recommended. An elevated loading dock with mechanical unloading equipment should also be provided (Piper et al. 1982). No other materials, such as chemicals or fertilizers, should be stored in the same area with fish feed.

A general storage area should be located near rearing ponds to store pipe, fittings, lumber, screens, nets, and other hardware. The use of wall space with shelves and built-in storage cabinets is suggested.

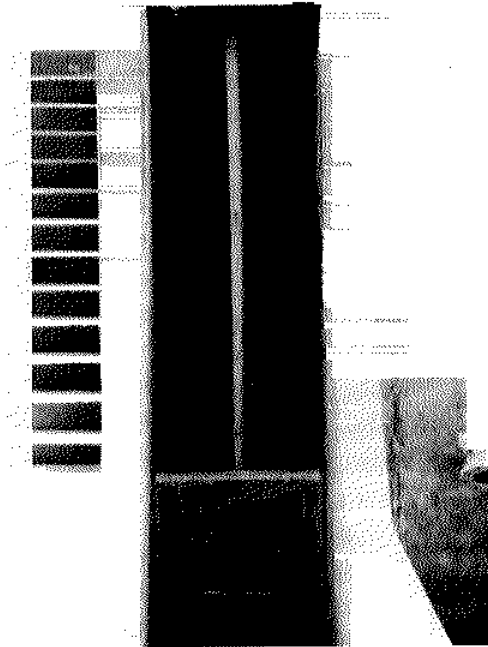

Figure 3.3. Water control structure in semi-intensive earthen ponds. Note water control dam boards and gate valve opening at bottom of structure. Photo Credit: Texas Parks and Wildlife Department.

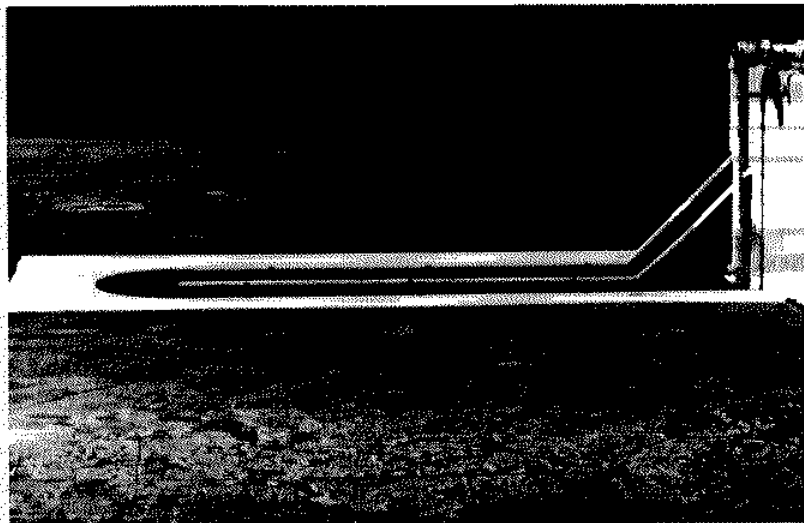

Figure 3.4. Concrete harvest kettle in plastic lined earthen ponds. Note harvest kettle is lower than pond elevation to allow for complete drainage and inflow pipe to provide continuous supply of fresh water during harvest. Photo Credit: Texas Parks and Wildlife Department.

A laboratory should be sized and equipped to analyze water quality, prepare samples for fish pathology, and count zooplankton samples. Basic laboratory equipment should include compound and stereomicroscopes, a spectrophotometer, pH meter, dissolved oxygen meter, salinity/conductivity meter, analytical scales, small centrifuge, and vacuum pumps. The laboratory should be temperature controlled and supplied with air, water, electricity, and gas. Sufficient storage areas for glassware, equipment, reference materials, and chemicals must be available. In addition, a safety cabinet should be provided for the storage of hazardous and flammable chemicals. Safety equipment should also be available for use in handling chemicals, and for treatment of personnel in the event of an accident.

A defined crew area provides space for meals and meetings, and provides locker space for each employee. Shower and restroom facilities should be provided. Sleeping quarters may also be necessary for employees assigned duty during specific operations when they cannot commute to and from home.

A garage and shop area large enough to store all trucks, tractors, fish transportation equipment, and other vehicles is recommended. The shop area should have an area of at least 500 square feet, with facilities for heating and cooling. It should be provided with 110- and 208-v power, non-skid concrete floor, at least two overhead doors, ample storage for tools, and adequate work space. All parts of the shop should be well lighted. Basic equipment includes a bench grinder, drill press, vise, table saw, circular saw, hand drill, air compressor, and an assortment of small hand tools.

A separate fertilizer and storage room should be equipped with explosion proof electrical fittings and positive ventilation to meet Occupational Safety and Health Agency (OSHA) requirements. The building size should be determined by predicting the maximum fertilizer storage requirements and calculating the necessary area. The floor should be concrete, with a slope of 1:10-inches to a center drain. A drive-through area or loading dock for trucks is recommended. Fertilizers and chemicals should be kept separate, because spillage can cause contamination or chemical reactions which may result in fire or explosions. For example, potassium permanganate (an oxidizer) should never be stored near fertilizers, chemicals, or petroleum products.

Collection, Transportation, and Handling of Striped Bass Brood Stock

David M. Yeager, James E. Van Tassel,
and Charles M. Wooley

Virtually every state in the Southeast produces striped bass (*Morone saxatilis*) or hybrid striped bass. For production purposes, states capture their brood stock from the wild, spawn them in hatcheries and return spent fish to the wild. However, some state, private, and U.S. National Fish Hatcheries have experimented with, or are now experimenting with, using domestic brood stock for striped bass production (i.e., Waddell Mariculture Center, South Carolina; Baltimore Gas and Electric Company, Maryland; Mammoth Springs National Fish Hatchery, Arkansas; Warm Springs National and State Fish Hatchery, Georgia). Domestication of brood stock can reduce or eliminate the need for collecting wild fish, thus reducing the expense, including personnel, associated with collection efforts. However, if the offspring of domestic brood fish are used to enhance or supplement wild populations, the resultant progeny could deleteriously affect natural populations of striped bass (see Chapter 11).

Collecting Sites and Methods

Collection site selection will depend on proximity to spawning grounds, presence of gravid adults on or near the site, water conditions, accessibility, a means to capture the fish, and temperature. Striped bass have been reported to spawn at temperatures from 54-72°F, with peak spawning between 61 and 66°F (Shannon and Smith 1968).

Inland collection sites for striped bass populations are typically river headwaters and above and below dams. At times, swift currents and water discharges below dams make it too dangerous to collect fish in tailrace areas. It is important to note that collecting in the vicinity of tailrace discharges, from hydroelectric or spillway effluents, can be *extremely dangerous*. Unpredictable currents, upwellings, and backwashes have resulted in individuals being killed or seriously injured. Therefore, *extreme caution should always be exercised*.

During periods of high discharge, it may be possible to coordinate collection activities with dam operators. Some operators are able to reduce flow for short periods, enabling collection crews to operate safely in these areas.

Striped bass brood fish are also collected in the tidal portions of some coastal rivers. Fish in these areas are generally associated with points of land, deep holes, large "flats," creek mouths, or some sort of structure such as bridge pilings. They are usually found in ripe, spawning condition in low salinity of 2 ppt or less waters.

Capture Methods

Brood stock of the various species of *Morone* can be captured from various inland and coastal systems. White bass (*M. chrysops*), white perch (*M. americana*) and yellow bass (*M. mississippiensis*) can all be readily caught by hook and line or trap nets, while striped bass are better caught by electrofishing or gill nets.

Electrofishing

Electrofishing can be defined as the use of an electrical current to capture, guide, or block the movement of fish. During the striped bass spawning season, when fish are concentrated in finite areas, electrofishing is one of the most efficient methods used for collection of brood stock. Brood stock collected by electrofishing are rarely subjected to rigorous struggling during the capture phase (as in a gill net), and often demonstrate electronarcosis for one to several minutes during the critical pick-up and initial holding period.

The use of electrofishing equipment to collect striped bass brood stock has been an accepted and useful practice for several years (Bayless 1972; Harrell 1984a) (Figure 4.1). The equipment can be locally designed or purchased as a partial or complete package from a commercial supplier. Great variation exists in techniques and performance of electrofishing gear, yet the basic premise of any electrofishing system design is to produce a sufficient response to an electrical stimulus to allow easy capture of fish with dip nets. Most collection systems consist of a boat, a gas powered alternating current (AC) generator that powers a voltage booster, a pulse shaper to provide AC or direct current (DC), and a series of electrodes which deliver the current into the water.

When DC is applied, striped bass demonstrate three basic responses. With the initial shock, they line up in the direction of the electrical current. Fish parallel to the electrical current swim toward the anode. Fish in other positions are forced to line up parallel to the current and are "attracted" to the anode. As striped bass approach the anode, their ability to move is greatly impaired and they will turn "belly-up" exhibiting galvanonarcosis. Therefore, fish shocked with DC exhibit a forced swimming (anodictaxis) toward the anode. This fish response is why pulsed DC is an effective means of capturing striped bass brood stock in tailwaters or high flow areas. Also, in most DC electrofishing systems, the electrical flow can be interrupted for short periods (pulsed). These pulses may be adjusted in frequency (pulses per second) to maximize electrofishing efficiency.

When fish are exposed to AC, they do not exhibit galvanotaxis, but instead align in a position transverse to the electrical current to receive a minimum amount of voltage, a phenomenon termed oscillotaxis. When shocked with AC, the electrical effect response is more

violent, and the reaction lasts longer. As a result of fish being immobilized without being attracted to electrodes, dip net handlers may be required to dip fish from considerable depths or distances from the boat. Brood stock often are immobilized at depths beyond the reach of the dip netter.

Unmodified AC voltage is more damaging to fish than DC voltage and may result in hemorrhaged tissue, ruptured swim bladders, and fractured vertebrae (Reynolds 1983). Damage of this magnitude generally renders striped bass unfit for use as brood stock. Pulsed or fully rectified AC voltage elicits a response similar to pulsed DC voltage, but is not as potentially harmful as unmodified AC. Alternating current has the largest range of action, especially in clear, shallow water with a sand or gravel substrate. Occasionally, if fish are being stunned too far from the electrodes, better performance can be obtained by reducing the output.

Advantages of electrofishing are that it is cost effective, and a large diversity of areas can be covered by most units. If used correctly, brood stock will be subjected to less stress which may result in increased potential for quality fry (see Chapters 5 and 12). However, electrofishing may result in lowered efficacy in collection, especially in deep water, streams and rivers with high velocities (5 feet/second), and very turbid waters (to which conductivity is

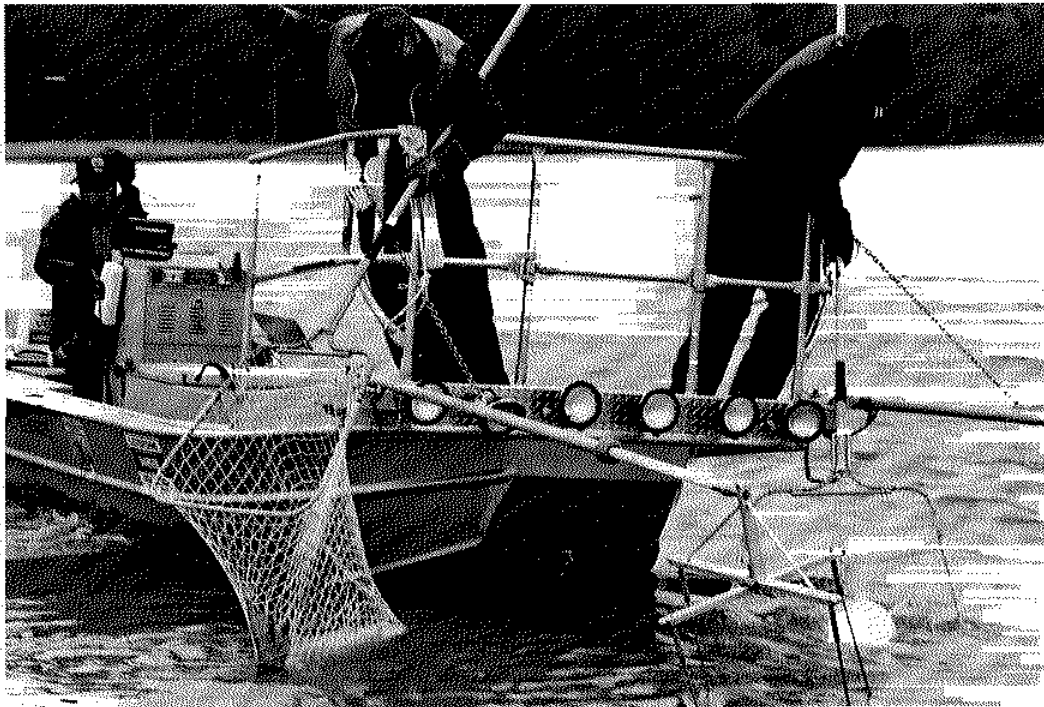

Figure 4.1. Electrofishing for striped bass brood stock. The electrofishing boat is usually accompanied by a second pick-up boat (not shown in this picture). Photo Credit: Wes Dixon.

correlated), or waters with high phytoplankton blooms where it may be difficult to observe fish. Basic considerations for the use of electrofishing as a collecting device for striped bass brood stock should include: location of the sampling site; depth of water; access; substrate; velocity; conductivity; size and abundance of fish; and the area of the spawning grounds.

Physiochemical and physiological factors affecting electrofishing efficiency include light and sound transmission in the water. Light penetration depends on phytoplankton levels, turbidity, and the amount of ambient light. Collection of brood stock at night may improve capture efficiency. Biologists assume this increased efficiency at night is due to striped bass generally being located close to the top of the water column then.

Striped bass of different sizes have been observed to respond differently to electrical current. Larger fish are more sensitive to electric current than smaller fish because they have a larger surface area and thus absorb more of the electrical current.

Water temperature governs fish metabolism and is a factor in fish vulnerability to electricity. As water temperature increases, the fish's metabolism increases. At optimal temperatures, the fish's reactions and swimming ability are maximized. However, it has been observed that as a female striped bass reaches the stage of 4-6 hours before ovulation, she becomes very docile, and response time decreases tremendously. Preliminary research indicates that as water temperatures change, voltage gradients and resistance to voltage that large fish encounter may fluctuate also. This change in the fish's resistance to electricity may account for differences in electrofishing efficiency over the course of a spawning season.

Safety precautions should always be observed while electrofishing. Electrofishing procedures and safety precautions have been well documented (Berry et al. 1983; Reynolds 1983), and should be frequently reviewed.

Gill Nets

Stationary and drift gill nets (Figure 4.2) can be used successfully to catch striped bass. These nets permit the worker to fish a large area of water and are useful in determining concentration areas and migration routes. However, these nets cause stress and physical damage to brood fish and are not the preferred capture method. Mortalities can be appreciable but losses may be reduced by checking nets and removing fish every 15-30 minutes, or when movement of surface floats indicate a fish has been captured. Mesh size for striped bass collection varies from 2- to 5-inch bar mesh multistrand nylon or monofilament webbing. Monofilament gill nets are more effective than multistrand nets in capturing fish but are also more harmful to fish.

Drift nets. Drift gill nets (Figure 4.2) are used in tidal expanses, bays, and flowing streams. Usually set perpendicular to the current, these nets are allowed to drift with the current. Normally, one end of the net is supported and marked by a float while the opposite end is controlled from a boat. Drift gill nets can be made to "walk the bottom" by carefully regulating the size of floats and bottom weights. These should be used in areas where water velocity is

consistent and the stream is free from underwater obstructions. Brood stock capture success with this method is limited because of the problems associated with fishing the lower strata of water, where striped bass are most often located.

In tidal areas of coastal rivers and bays, nets are commonly set and fished during slack tide, which may be as long as 60 minutes. Several nets, 150 yards long, can be used simultaneously in large bays or coastal rivers. Floats are watched by the collection crew, and when movement (bobbing) is noticed, the brood fish should be removed as soon as possible, usually by cutting the mesh, not by untangling the fish. During slack tide, the crews can maneuver the boat alongside the drift net and remove captured fish without disturbing or interrupting the net's fishing ability.

Stationary nets. Stationary gill nets can be utilized in streams or reservoirs. The net can be set to fish any depth, and are very effective in capturing striped bass. During the spawning season, the more successful sets are usually located in the upper tributary arms of reservoirs; however, sets in the lower portions of reservoirs, at the base of dams, have also been successful. Water depths for successful gill net sets vary from the surface to 30 feet deep. Sets are normally



Figure 4.2. Fishing drift gill nets used for capturing mature striped bass on the spawning grounds. Photo Credit: Merrill Leffler.

made perpendicular to the main channel, along gradual slopes outside the swiftest part of the current. Nets are generally worked in the evening, but when attempting to locate concentrations of fish they may be left throughout the day and night. It is advisable never to leave a net set for more than 30 minutes in which putative brood fish may be captured. The reason for not leaving the nets any longer is obviously because of the cumulative stress on the brood stock trapped in the net. Nocturnal sets are reported as most productive.

Trammel nets can be used exactly like gill nets and are equally effective. Personal observation (Wooley and Van Tassel) suggests that stress to the fish may not be as severe with a trammel net.

Bow Nets

The bow net is effective because it can cover a precise depth where striped bass are concentrated prior to spawning, and has minimal effect on the fish's physical condition (Bayless 1972; Harrell 1984a). This specialized gear is most effective in deep, swift rivers on or near the spawning grounds. The device resembles an oversized dip net. The hoop is approximately 6 feet in diameter and the staff is approximately 20 feet long (Figure 4.3). The net is fished from a boat which is permitted to drift with the current while the hoop is held vertically near the bottom. Water current pushes the boat slightly faster than the net, thus keeping the bag of the net extended upstream. The worker can "feel" the fish touch the net and entangle it in the bag by pulling straight up on the staff.



Figure 4.3. Bow net used to collect striped bass brood stock from spawning grounds. Photo credit: North Carolina Wildlife Resources Commission.

Trap Nets

The effectiveness of any type of trap device used to capture striped bass depends on the location of the set, and the equipment and manpower required to rig and empty the trap. Various types of traps have been used successfully to capture striped bass, especially during spawning runs; however, entrapment gear is usually limited in its application due to site selection, manpower requirements, mobility, and equipment expense. Traps designed with wings and leads are usually not appropriate in swift waters or where irregularly shaped bottom contours are present. Large traps and pound nets often require some type of mechanical winch or block-and-tackle assembly in order to set or remove fish from them.

Pound nets. Pound nets (Figure 4.4) have been successful in some Atlantic Coast states for capturing brood fish. They are expensive and require expertise to set. Sites suitable for pound nets are usually level bottom areas, less than 8 feet deep, within reservoirs, rivers, and estuaries. Often these sites are not near natural spawning grounds, and captured fish may not be sufficiently advanced to successfully induce ovulation. However, pound nets fished in 20 feet of water in the St. Johns River, Florida, have been very successful in collecting eligible brood fish.

Hoop nets. Hoop nets are long, conical traps constructed of progressively smaller hoops covered with web netting. Inside the trap are one or two funnel-shaped throats which open into larger chambers. Fish swimming through the throats become trapped inside the larger chambers. Hoop nets are usually set entirely submerged with the open end situated down river. Some states have reported using 4- to 8-foot diameter hoop nets for capturing striped bass during spawning runs in rivers and upper tributary streams. The hoop net is the only trap designed for use in swiftly flowing water.

Fyke nets. Fyke nets are modified hoop nets with one or two wings, or a leader of webbing, attached to the mouth to guide fish into the enclosure. The net is set so that the wings or leader intercept the fish. When fish follow the wing or leader in an attempt to get around the netting, they swim into the hoops. Fyke nets are generally set in shallow water as deep as the height of the wings or leader and the height of the first hoop or frame. They can be used in lakes and reservoirs, streams, and rivers with little to moderate currents (Hubert 1983).

Hook and Line

Mature fish can be collected from cooperating fishermen in tailwater areas of dams, or where fish are concentrated and vulnerable to fishing pressure. Fish are quickly removed from the hook, and immediately placed in transport tanks equipped with agitator units or supplemental oxygen. Handling should be kept to a minimum. Mature males are frequently taken by this method when all other methods have failed. Mortality rates due to stress are usually high, especially among gravid females.

Radio and Ultrasonic Telemetry

Telemetry equipment can be a very useful tool in following striped bass to spawning areas or locating concentrations of spawning fish (C. H. Hocutt, University of Maryland, Horn

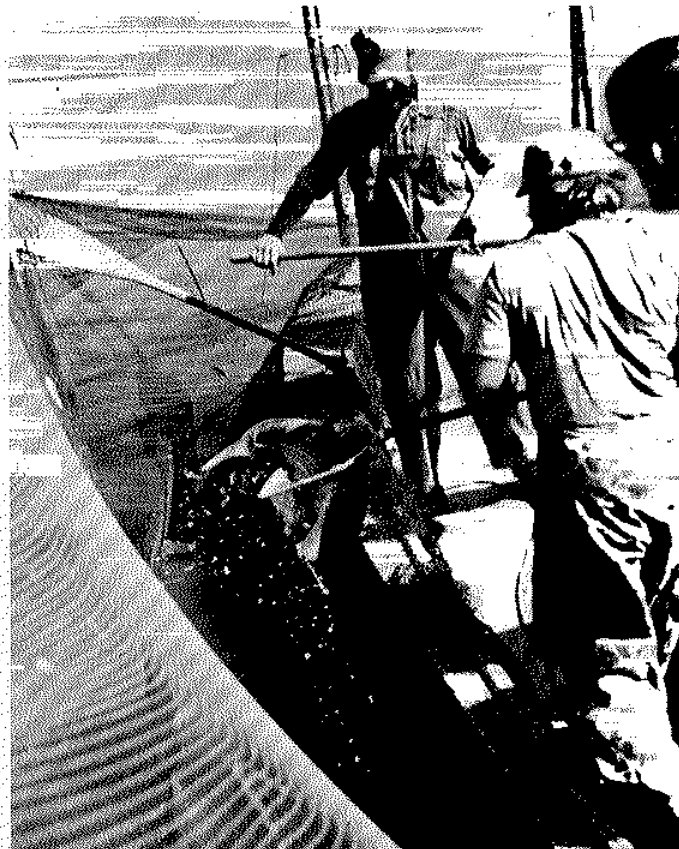
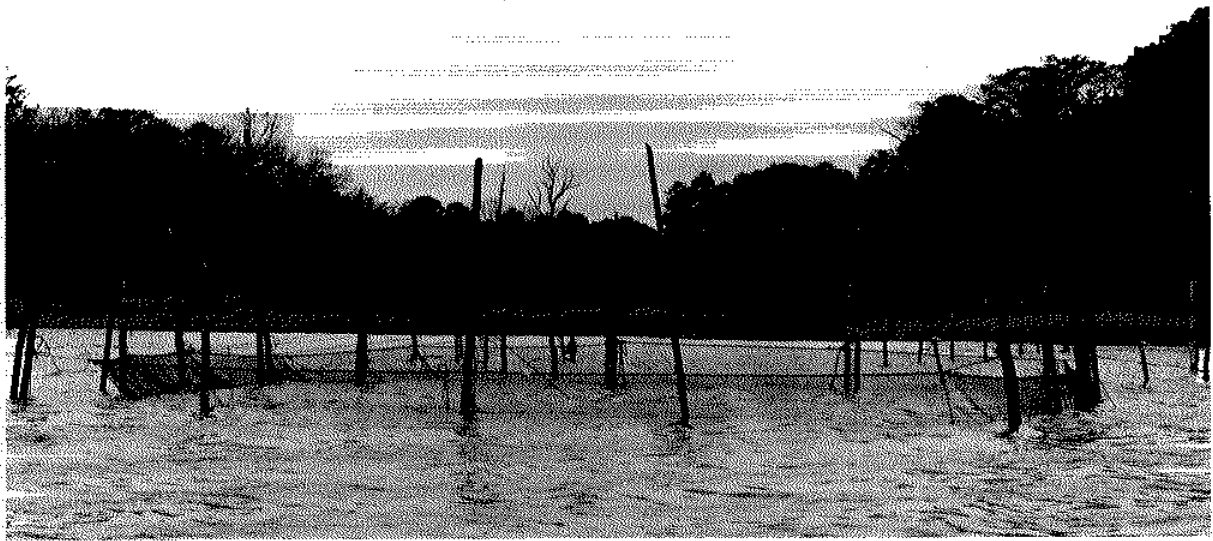

Figure 4.4. Pound net used to capture mature striped bass near spawning grounds. Photo Credit: South Carolina Wildlife and Marine Resources Department.

Point Environmental Laboratories, personal communication). Transmitters can be surgically implanted or externally secured to the fish (Hart and Summerfelt 1975; Yeager 1985). In addition to standard locator transmitters, temperature transmitters for radio and ultrasonic equipment are available.

Radio telemetry equipment consists of a receiver and a hand held or boat mounted antenna. Each transmitter emits radio signals on different frequencies, enabling individual fish to be identified by a specific frequency. A scanner may also be used in conjunction with the receiver, which enables the operator to search for two or more fish simultaneously.

Ultrasonic equipment consists of a receiver and a listening device, known as a hydrophone, which must be submerged in the water to receive the signal. Ultrasonic transmitters are usually set at a specific frequency, and individual transmitters are identified by the number of beeps or pulses per minute.

With radio telemetry equipment, a large body of water may be searched by boat or aircraft in a relatively short period of time. However, with ultrasonic equipment, more time must be spent searching because the boat must be slowed or stopped, and the hydrophone lowered into the water to detect the signal. A disadvantage of radio equipment is that it cannot be used in waters with high conductivities, such as tidal areas of rivers, estuaries, or bays, because radio signals will not transmit through brackish or salt water. Also, radio telemetry equipment can be more costly than ultrasonic equipment.

Transportation of Brood Stock

Equipment

When transporting brood fish, it is best to use circular or oval transport tanks, rather than rectangular or square tanks, which can impede swimming motion with 90°-angled corners. A circular configuration allows brood fish to swim unrestricted, thus mitigating stress from confinement on captured fish. Rectangular or square tanks can be used for transporting smaller (<10 pounds) brood stock, but even for smaller fish, they are more stressful than circular tanks.

Transport tanks should be constructed of sturdy materials and insulated for better control of water temperature. A circular metal "stock watering" tank may be substituted for short hauls when water temperature is not a problem (Figure 4.5). The exterior of the tank should be white or remain silver (aluminum) to reflect sunlight, and the interior tinted black. The tank should be equipped with a locking, water tight lid that allows easy access for fish insertion and removal.

Transport tanks should be supplied with bottled oxygen, rather than compressed air, and equipped with a means to recirculate the water. Water recirculation establishes a current which helps brood fish maintain balance and orientation into the current. Brood fish also appear to respond to captivity (handling) better when placed in tanks with recirculating or flow-through water that provides some current.

Size of transport tanks are dictated by the relative size of brood stock being handled. Generally, a fully equipped (oxygen, recirculated water), circular transport tank should be able to adequately haul approximately 1/3 pound of fish per gallon of water. Tank diameter is as equally important as the volume of water. Brood fish longer than 30 inches should be transported in tanks with a diameter no less than 6 feet, and depth of 2-3 feet. Fish under 30 inches can be transported for short distances in 5 foot diameter tanks, 2 or 3 feet deep. If rectangular tanks are the only alternative, the tank's configuration (length and width) should be at least twice as long as the length of the largest fish to be transported.

A 5-foot diameter x 2-feet deep, 300-gallon transport tank can be hauled on the bed of a 3/4-ton pick-up truck. For added versatility, this vehicle can also tow a trailer outfitted with a 6-foot diameter x 2-feet deep, 400-gallon circular tank. This combination maximizes the hauling capacity of the vehicle and is an effective, practical method for transporting brood fish short distances. The trailer should be equipped with its own separate braking system for sudden stops. Transport vehicles must be powerful enough to haul tanks when fully loaded with water.

Transport tanks larger than 6 feet in diameter require a much larger transport vehicle, such as a diesel-powered, 20-foot long flat bed tandem axle truck (Figure 4.6). This truck may be equipped with two, 8-foot diameter x 3-feet deep circular fiberglass transport tanks with 1,000 gallon capacities. This type of vehicle is extremely effective in transporting striped bass for long periods of time (3 hours or more).

Tank Water Quality

Whenever possible, hauling tanks should be filled from the body of water where the brood fish were collected. Reconstituted sea salt or NaCl should be added to the hauling water to raise the salinity to 8-12 ppt. An approved U.S. Food and Drug Administration fish anesthetic such as tricaine methanesulfonate (MS-222) may also be used in hauling brood fish. For the transport of brood fish, concentration rates of MS-222 will vary according to fish size and water temperature. At water temperatures between 55 and 65°F, concentrations from 3-5 ppm for brood fish over 30 inches, and 5-8 ppm for those under 30 inches, have been found to be adequate. Caution is recommended before using MS-222, to transport brood fish which are used exclusively for natural tank spawning, because full recovery for brood fish exposed to MS-222 requires a greater length of time than for previously used anesthetics, such as quinaldine. This extended recovery period could possibly disrupt the fish's natural spawning rhythm, particularly in larger fish close to ovulation (also see Chapter 5 concerning pH and MS-222).

Temperature of hauling water should be 65°F or less, and ice can be added if temperature becomes too warm. Piper et al. (1982) recommended dissolved oxygen (DO) concentrations greater than 7 ppm. There should not be a problem with accumulation of ammonia provided the tanks are not over-crowded, water is kept cool, adequate aeration is provided, and tank water is changed after each load transported. The use of anti-foaming agents to eliminate surface foam build-up and prophylactic treatments to guard against disease should be considered optional choices of the culturist.

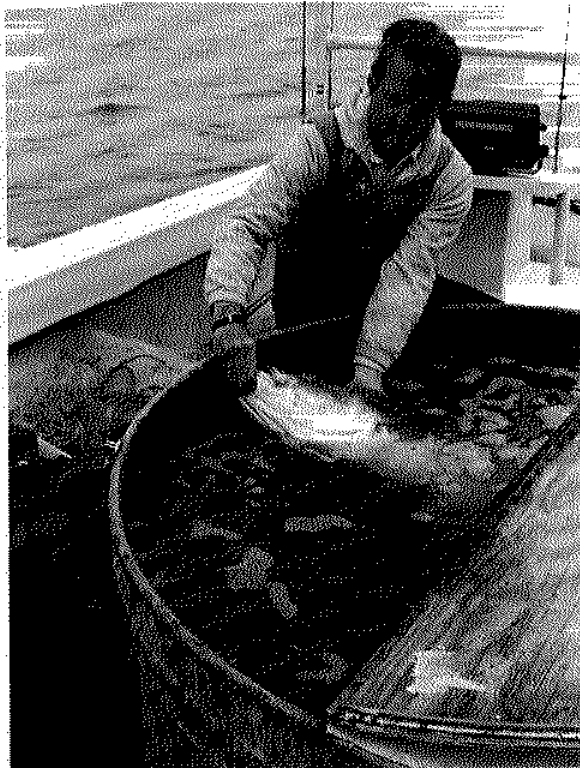

Figure 4.5. Circular tank for holding and transporting striped bass brood stock. Photo Credits: (A) Reginal M. Harrell, (B) Maryland Department of Natural Resources.

Handling of Brood Stock

Handling Equipment

The most important factor the fish culturist always has to be aware of is brood fish stress. Handle them quickly, without undue excitement to the fish. Salt, anesthetics, and oxygen help to reduce stress during handling and hauling, and may be used throughout spawning and culture activities. Factors such as adequately sized holding tanks, avoiding overcrowding brood fish, covering holding tanks, reducing bright light, and preventing loud noises aid in minimizing stress to brood fish. However, first and foremost, the cardinal rule in striped bass culture is to minimize handling of brood fish. The less the fish are handled, the less stress the fish are subjected to.

Before the beginning of each spawning season, all tanks and associated handling equipment that will come in contact with eggs, larvae, or brood fish should be cleaned thoroughly. This precaution reduces the possibility of mortality associated with toxic residues which may have accidentally accumulated during storage. Special attention should be given to egg and larval holding tanks because of their low tolerances to a variety of chemicals. Tubs, buckets, and tanks used for mixing herbicides or pesticides should not be used in any striped bass culture related activities, even if they are thought to be clean.

Every effort should be taken to avoid exposing brood fish to direct sunlight, because brood fish exposed to intense direct sunlight will stress quickly. Also, sunlight may heat the water beyond tolerance levels and irritate the fish, so holding tanks at the hatchery should be indoors to eliminate problems with direct sunlight and to more efficiently control water temperatures. These tanks, even though indoors, should be covered to keep fish from being stressed by people walking or working near the tanks.

Water in holding tanks should be drained and replaced each time brood fish are removed. Water quality in tanks holding brood fish on a continuous basis (e.g., the tanks with male fish) should be periodically monitored (DO, ammonia, pH), and water should be exchanged with fresh water when needed.

Use of live traps or live boxes to temporarily hold brood fish until sufficient numbers can be collected for transport is not recommended. Brood fish held in such devices tend to damage themselves on the walls and will quickly develop fungal infections if not promptly removed and treated.

Plastic dip nets such as polypropylene or polyethylene should be avoided, because these materials tend to be very stiff and will easily abrade scales and mucus from fish. Brood fish should be lifted or carried in soft netting material such as knotless nylon. A sling can be easily made of small mesh knotless nylon netting and two 1-inch diameter x 4-foot long poles (Figure 4.7). Brood fish can be lifted from one holding tank to another once they have been cradled and wrapped tightly in the sling.

Determination of Spawning Condition

Once brood fish are collected, an egg sample can be taken in the field from each female to determine her eligibility as a spawning candidate (see Chapter 5 for techniques). Visual inspection of the eggs in a clear tube is sufficient to determine eligibility. More exact staging of the hour of ovulation can be accomplished at the hatchery by microscopic examination of an ovum sample. Brood fish which will ovulate in 15 hours or less (see Chapter 5) are selected as eligible candidates for hatchery culture purposes. Brood fish more than 15 hours from ovulation are considered ineligible in some hatcheries and are immediately released. Those fish with eggs 9-15 hours prior to ovulation should be considered for manual stripping and should be administered a hormone to stimulate ovulation immediately after capture (consult Chapters 5 and 6). Injection of fish after capture minimizes stress by reducing the amount of handling. The stage of egg development should be recorded each time the fish is checked to refine the projected ovulation time. In the Chesapeake Bay, brood fish captured within eight hours of ovulation generally need not be injected with hormone, because usually these fish will spawn successfully if paired in tanks within 12 hours without hormonal injections. However, fish from different geographical regions and times of seasonal ripeness may still require injection of ovulation or maturation hormones, even at this advanced stage of development.



Figure 4.6. Large tandem-axle transport truck suitable for holding two eight-foot 1000 gallon tanks. Photo credit: Maryland Department of Natural Resources.



Figure 4.7. Knotless nylon sling that can be used to safely transport large striped bass brood fish. Photo Credit: Maryland Department of Natural Resources.

Artificial Spawning and Fry Production of Striped Bass and Hybrids

Robert A. Rees and Reginal M. Harrell

Brood Fish and Handling

Steps must be taken to mitigate stress associated with the capture and handling of brood stock as emphasized in Chapter 4. Brood stock arriving at the hatchery should immediately be placed in a stress-recovery tank containing 7.5-10 ppt NaCl or synthetic sea salt for at least 1 hour. Ideally, brood fish are held in a system in which the salinity remains between 3 and 10 ppt. An alternative is to place the arriving fish in a tank with 3-10 ppt salt and allow freshwater inflow to slowly dilute the salt concentration over several hours. This procedure will reduce stress associated with initial handling and hauling.

Although brood fish are usually docile, the stresses they undergo while in captivity can affect their health, ova maturation, ovulation, and embryonic development. Tomasso et al. (1980) found significant increases in corticosteroids and hypochloremia in striped bass hybrid (white bass, *Morone chrysops* x striped bass, *M. saxatilis*) fingerlings which were held in a net for 10 minutes. Similarly, Harrell and Moline (1988) reported increased corticosteroid levels and changes in blood chlorides in brood stock captured by both gill nets and electrofishing, although the latter was the least stressful method of capture. In both cases it was concluded that the increase in corticosteroids and decrease in chlorides was due to stress induced by osmoregulatory dysfunctions. Tomasso et al. (1980) reported that hauling hybrid striped bass in 25 ppm MS-222 (tricaine methanesulfonate) and 10 ppt NaCl greatly enhanced survival.

To prevent further stress, data (such as length and weight) should be collected either at capture, or immediately before placing the fish in the holding tanks. Initial egg sampling and hormone injection should be performed on arrival at the hatchery, if not done at the time of capture. Separation of males and females is important to prevent spawning in the holding tanks. Holding tanks should be large enough to allow the fish sufficient swimming and turning room, but small enough to facilitate capture without undue harassment (Figure 5.1). Circular tanks appear to be the best design as the brood stock can swim without encountering a square corner, becoming disoriented, and struggling to turn around.

(A)

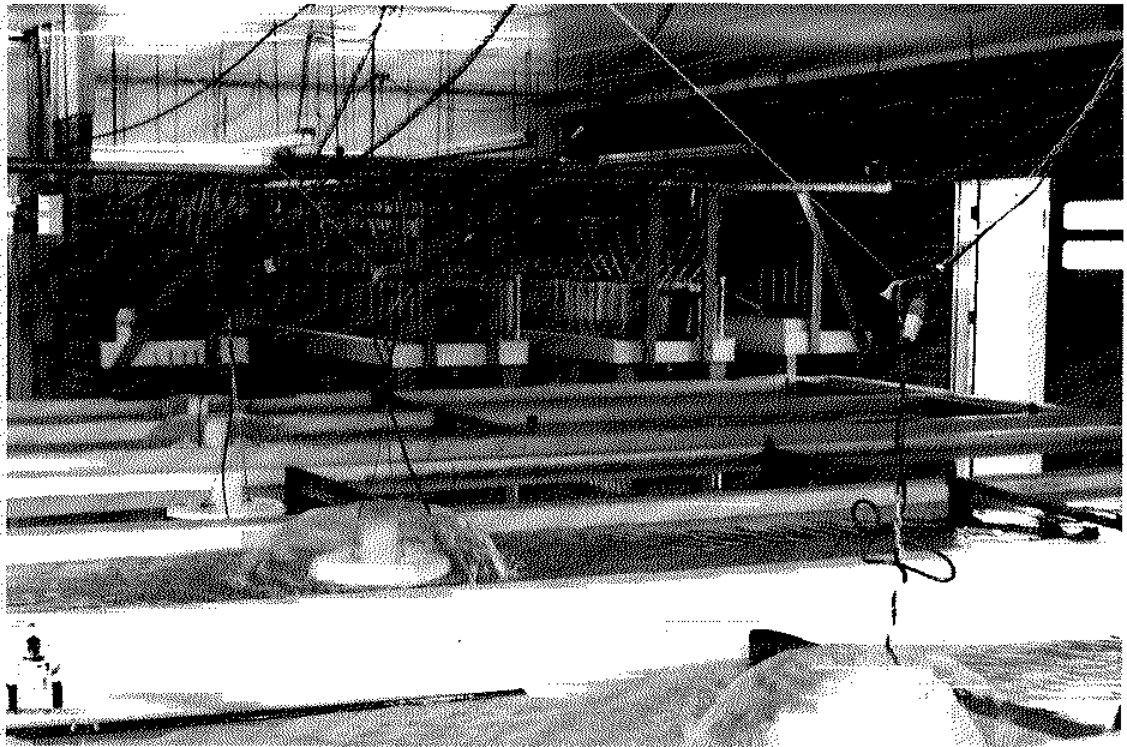

(B)

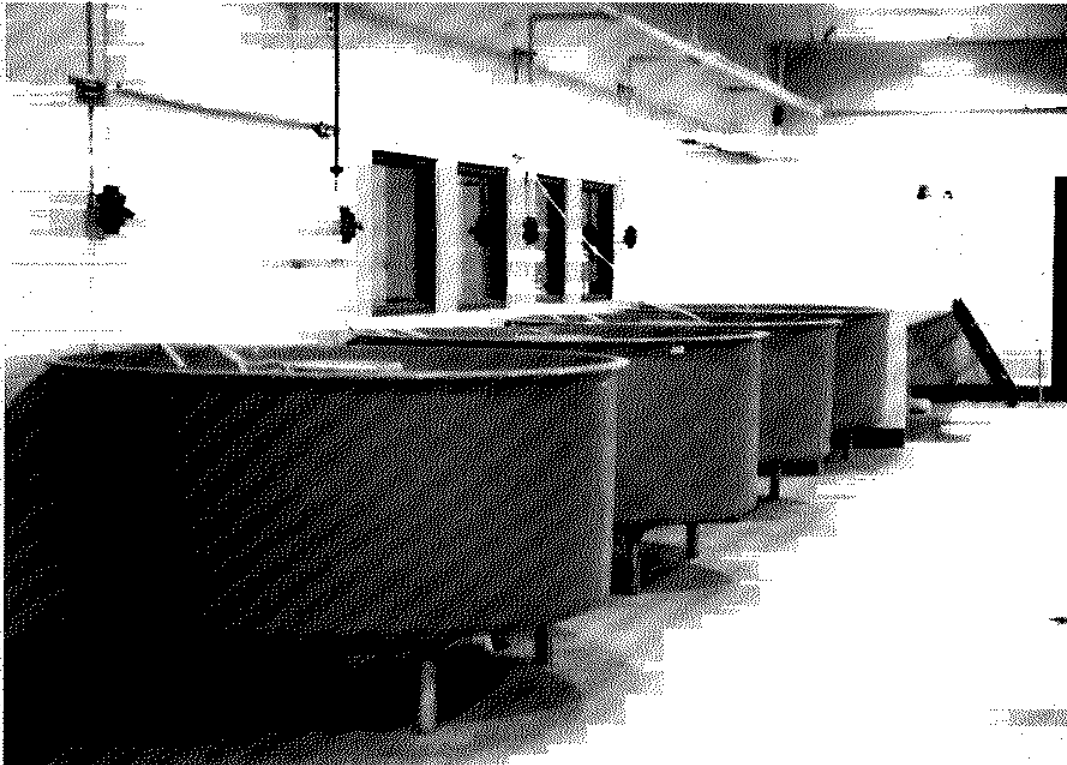

Figure 5.1. Brood fish tanks used to hold large striped bass before spawning. Photo Credits: (A) Georgia Department of Natural Resources; (B) Tennessee Wildlife Resources Agency.

Water temperature in the holding tanks should remain constant and should be the same as the temperature in the egg incubation system. Water temperatures between 62 and 68°F are considered optimum during artificial propagation. Oxygen concentrations should be between 6 ppm and saturation in the tanks to maintain good fish health and ova development. Super-saturation of total gases should be avoided in all cases. Identification of each brood fish is necessary to monitor its progress through ovulation and disposition if spent brood stock are returned to a particular river or system. Methods of identifying individuals include fin clipping, attaching plastic numbered or color coded tags, numbering the holding tank or tank section, pit tags, or using some physical characteristic of the brood fish (e.g., size, light or dark color, anomaly, plumpness). If possible, females should be maintained in individually numbered tanks.

Handling brood fish, especially the females, should be kept to a minimum. Frequent handling retards ovulation, reduces hatch rates, promotes disease, and increases mortality. Dip nets or seines used in handling should be constructed of 0.5-inch or smaller knotless netting to prevent injury to the fish. Bayless (1972) reduced brood fish handling-induced mortality before spawning by injecting females with hormones immediately after capture, taking only one egg sample to predict ovulation, and releasing females that did not ovulate within 72 hours after capture. Although most culturists must rely on additional egg samples to predict ovulation, *sampling and handling* should be kept to a minimum.

In southerly latitudes, male striped bass mature sexually by 2 years of age and females by 3 years of age (C. C. Starling, Florida Game and Fresh Water Fish Commission, personal communication). Further north, maturity may be delayed to as long as 3 and 6 years for males and females, respectively. White bass males and females generally reach sexual maturity in 2 years (Bonn et al. 1976).

Hormone Injection

Various types and combinations of hormones can be used to induce ovulation of eligible female brood fish (Stevens 1966). Hormones tested included human chorionic gonadotropin (HCG), follicle stimulating hormone (FSH), luteinizing hormone (LH), thyroid stimulating hormone (TSH), estrogen, testosterone, and fish pituitary glands. Stevens (1967) found that HCG and FSH induced ovulation when used alone, while Bayless (1972) recommended using HCG as the preferred hormone for use in *Morone* culture. Human chorionic gonadotropin is currently preferred by most culturists because it is effective, economical, and readily available from fisheries suppliers, veterinarians, and pharmaceutical firms. It is available in human or veterinarian grades; either is acceptable. Most HCG is packaged in vials of 5,000, 10,000, or 20,000 International Units (IU) per vial.

While the action of HCG is specific to the ovulation process, research is currently being conducted on different chemicals such as synthetic gonadotropin releasing-hormone analogues (GnRH_a) and dopamine antagonists, such as domperidone. These hormones show promise as potential maturation hormones that could replace HCG and enhance development of domesti-

cated brood stock (C. V. Sullivan, North Carolina State University, personal communication). Maturation hormones, unlike the ovulatory hormones, act on the pituitary gland, which regulates the egg maturation process. Thus, it is obvious that these hormones can play an important role in out-of-season spawning (see Chapter 12).

As noted, female brood fish should be injected either at the time of capture or as soon as possible after arrival at the hatchery. Recommended dose levels for striped bass females are between 125 and 150 IU of HCG per pound of body weight (Stevens 1966; Bayless 1972; Bonn et al. 1976; Kerby et al. 1983a). Some culturists currently use 200 IU of HCG per pound as the standard dose because it is easier to calculate injection amounts. It appears that 125 IU/pound represents the threshold dose (minimum dose) required for ovulation; however, doses exceeding the threshold appear to have no negative impact on ovulation success. Thus, an "experienced" estimate of the fish's weight, rather than precise measurements on scales, is adequate for calculation of dose levels. It also avoids excessive handling.

White bass females should be injected with HCG at a dose between 500-1000 IU/pound (Bonn et al. 1976). Reinjection of females with HCG usually results in abortion of eggs, and should be avoided (see Chapter 11 for details on hybridization).

Milt production in male striped bass can be enhanced by injecting them with 50-75 IU of HCG/pound. Injection with HCG in males will enhance semen "production," in that it appears to cause hydration of the testes, increasing the volume of seminal fluid. It will also "bring back" males that are "drying up" (the semen is very viscous), and will enhance that material's ability to fertilize eggs. However, it has not been demonstrated to stimulate production of spermatozoa. The number of spermatozoa per unit volume is reduced after treatment with HCG, but fertilization percentages were similar with treated and non-treated males (J. H. Kerby, Fish Culture Research Laboratory, U.S. Fish and Wildlife Service, personal communication). White bass males can also be injected with HCG at 100-200 IU/pound, which prolongs their availability for use in hybridization.

Human chorionic gonadotropin is normally injected intramuscularly just ventral to the first dorsal fin above the lateral line. If hormone injections are made intraperitoneally, special care should be taken to avoid damaging internal organs.

Normally, the fish to be injected is netted, but it is possible to administer injections without manually constraining the female. The fish is usually corralled into a confined space, about as long as the fish's length, and the needle is slid underneath a scale by "feel" and quickly inserted into the flesh. Release the syringe, although normally the fish will not "run," then recatch the syringe and administer the dose. This technique usually works well and avoids stress to the female.

The latency period of HCG is temperature dependent (i.e., about 16 hours at 68°F or 22 hours at 62°F). Females with ova that are naturally advanced in development (close to natural spawning) will usually mature and ovulate without hormone injections.

In general, it is difficult to predict from a field examination when a fish that is more than 12 hours (see below) from natural spawning (termed a "green" female) will actually ovulate. Yet, a 10-hour "natural" fish will normally ovulate within 20-36 hours after injection with HCG, depending on temperature. Of course, there are exceptions to every case, for example, Tennessee hatchery biologists do not consider any fish, except immature females, ineligible (those fish which would not spawn even under the influence of hormonal injection). They inject all females, regardless of the natural stage of development (J. M. Smith, Tennessee Wildlife Resources Agency, personal communication). In Maryland, brood stock collected on the spawning grounds that are less than 8 hours from spawning naturally are not injected, but generally spawn (usually in tanks) within 8-12 hours following capture.

Predicting Ovulation

One of the drawbacks to manually stripping eggs from female striped bass is that, with current knowledge and use of hormones, the culturist must accurately predict when the female will ovulate. This prediction time is critical because eggs taken from a female too soon before or too long after ovulation will not fertilize, or will have such low fertilization rates that it is difficult to justify committing hatching jars or tanks. When the eggs ovulate, they separate from the ovarian tissue and parental oxygen supply. If they are not taken within a short period of time, they will begin to deteriorate (go overripe) due to anoxia.

Predicting exactly when a female will ovulate is still more art than science. Although the photographs of egg stages in this chapter provide a good guideline for predicting ovulation, fish captured from different populations and held at different temperatures may not respond as expected. The best way to learn to predict ovulation is by learning how the fish you have captured respond in relation to the representative egg stages (see Figures 5.3-5.5). There is no substitute for "hands-on" experience in spawning striped bass.

Most of the information that follows is based on using HCG to induce ovulation and holding the fish in water at temperatures near 66°F. Time to ovulation may vary with the "natural" stage of the fish and the water temperature.

Depending on water temperature, and how far natural development has progressed, striped bass require from 15 to 60 hours to spawn under the influence of hormones (Bonn et al. 1976). The latency period of "early season" females is usually longer than that of "late season" females. Generally fish with eggs that have partially cleared by 15 hours after injection are successfully spawned. Only eggs classified as immature have proven to be ineligible (Bonn et al. 1976).

Fish are sampled between 20 and 28 hours after injection because it normally takes between 15-20 hours for HCG hormone to have an effect. Samples taken before 20 hours will probably result in a false reading; however, differences between females in different areas can result in missing ovulation if care is not used. For instance, in the Maryland portion of the

Chesapeake Bay, striped bass respond to the hormone more rapidly than most other strains perhaps because they are captured on the spawning grounds.

Staging Eggs

In general, Maryland striped bass are staged (an egg sample is taken and examined for progression toward ovulation [see Figures 5.3-5.5]) at capture, the observed developmental stage or "natural" time is then added to 12 hours, and 1-2 hours are subtracted to determine when the female is to be checked for spawning or further refinement in prediction of the time of ovulation. For instance, a "natural" 10-hour fish will be checked in 20-21 hours for ovulation (J. E. Van Tassel, Maryland Department of Natural Resources, personal communication).

Accurate egg staging requires a low power (10-30x) stereo microscope. A sample of eggs is taken by carefully inserting a small catheter (≈ 3.0 mm outside diameter [OD]) approximately 2-3 inches into the urogenital pore (Figure 5.2). Care should be taken to avoid damaging the sphincter muscle or the ovarian wall. Hemorrhaging caused by improper insertion of the catheter may result in clotting and blockage of egg flow at ovulation.

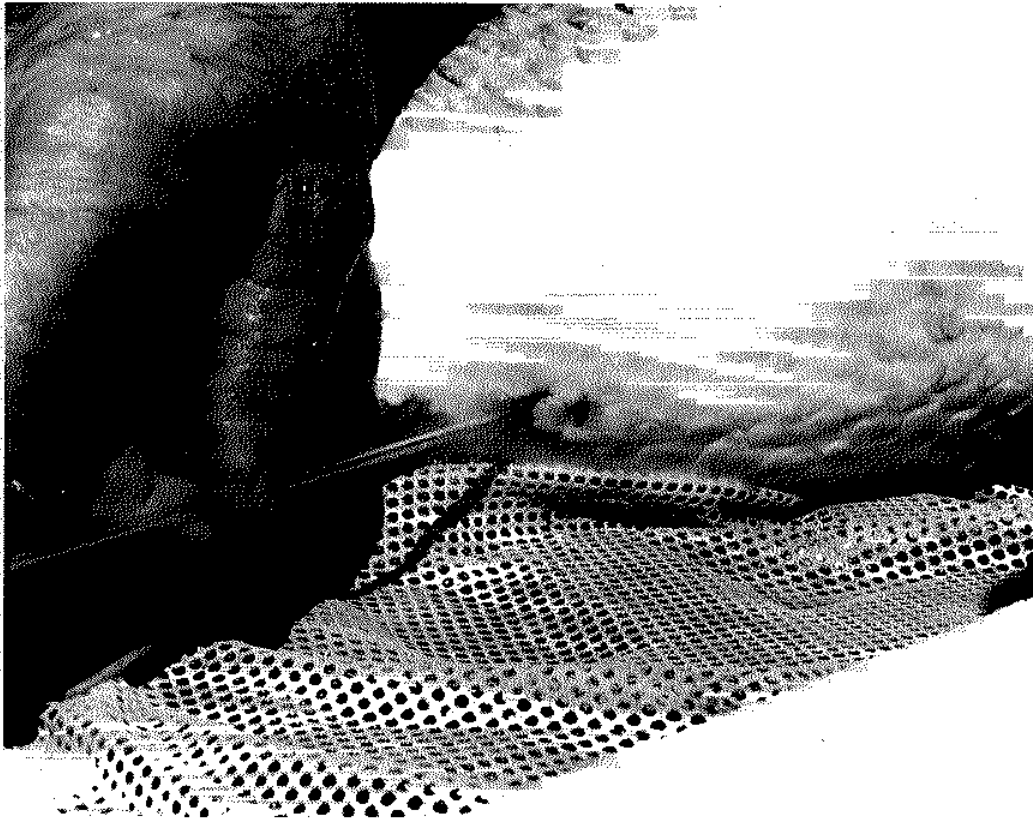

Figure 5.2. Catheterization of female striped bass. Photo Credit: Reginal M. Harrell.

Only one sample should normally be taken to estimate ovulation, because repeated sampling can delay ovulation from one to several hours and may result in mortality of the female or "abortion." Under some conditions, especially when initially learning the staging techniques, additional sampling may be required to prevent the eggs from becoming overripe. Whenever possible, however, keep egg sampling to a minimum.

Eggs taken more than 15 hours before ovulation cannot be accurately staged. Also, it is difficult to accurately predict time of ovulation for fish with eggs that are more than 12 hours from spawning. Ovulation can be most accurately predicted for fish that are 6 to 10 hours from spawning.

The stages of egg maturation are shown in Figures 5.3-5.5. In the following paragraphs, we will describe the various stages in ovum maturation and discuss characteristics that will allow proper evaluation of the individual stages. The pictures were taken with transmitted light, and it is important to note that eggs have a different appearance under reflected light.

Ineligible eggs (Figure 5.3). These eggs are very small, often non-uniform in size, usually less than 600 μm in diameter, and are a yellowish color. Little or no internal organization is apparent. They are primary oocytes that will probably not mature until the next year.

15 hour eggs (Figure 5.3). At this stage, the eggs are opaque. The oil droplets are completely scattered throughout each egg, but are clearly discernable as oil droplets, as opposed to ineligible eggs, in which no droplets can be identified. Each egg may be 1 mm in diameter or larger. Eggs are usually greenish in color and usually clumped together.

13-14 hour eggs (Figure 5.3). There is little difference between eggs at this stage; prediction is subjective. The oil droplets are beginning to coalesce into larger droplets (globule), and the eggs are becoming somewhat translucent.

11-12 hour eggs (Figure 5.3). Although not complete, polarization of the oil globule is becoming well defined, especially by 11 hours. There are still many fine oil droplets, and the egg is more translucent.

9-10 hour eggs (Figure 5.4). Polarization is complete and the oil globule is formed. At 10 hours the egg is still grainy in appearance, with dark shadows around the oil globule. At 9 hours, these shadows and the grainy appearance begin to "clear" and the egg is becoming transparent. The eggs are now less adhesive to each other.

5-8 hour eggs (Figure 5.4). There are still some areas of translucence immediately around the oil globule. As time progresses, the proportion of translucency to transparency decreases. The chorion is still rigid.

1-4 hour eggs (Figure 5.5). During this period, it is difficult to stage the eggs because differences are subtle. Experience will be the best guide in learning the differences between a 2-

and a 4-hour egg. The main points to look for are the degree of egg clarity which progressively clears as the egg nears time of ovulation. Two hours before spawning the eggs (yolk) are almost completely transparent, but they are still not yet ready to ovulate. At 1 hour the chorion loses some of its rigidity and the eggs begin to hydrate slightly, increasing in size to 1.2 mm or larger.

In Maryland, biologists may take a sample of eggs during this time period and place them in water for several minutes. If the eggs begin to water-harden in a few minutes they project the fish is about 2 hours from ovulation; however, if they begin to water-harden immediately, they are about an hour away from ovulation. An egg that is 1 hour or less from ovulation will have little to no clumping (J. E. Van Tassel, Maryland Department of Natural Resources, personal communication).

Ripe eggs at ovulation (Figure 5.5). Ripe eggs are probably the easiest to identify, apart from immature eggs. They are completely transparent, the oil globule has a greenish tinge, and, most importantly, the chorion has become so flexible that the shape of the eggs will form hexagons as they compress next to each other. Slight pressure from another object such as a dissecting needle will cause the membrane to move back and forth with pressure that previously would have been sufficient enough to move the entire egg.

Overripe eggs (Figure 5.6). Within 1 hour after ovulation, eggs that were previously clear begin to break down at the junction between the yolk and the chorion. It appears that the yolk is tearing away from the chorion, and the area is generally an off-color (yellow to light brown). The area will increase in size over time. Eggs that exhibit this characteristic are not fertile and eventually will die.

Verification of Ovulation

Interestingly, the female demonstrates a behavioral change as she nears ovulation. Usually she becomes quite docile and can be found near the bottom of the holding tank. Often her head will be down with the caudal region elevated. Some females may start to swim slowly near the surface occasionally breaking the surface, while others may remain quite still near the bottom of the tank.

During ovulation, the eggs will detach from the ovarian tissue and will be loose within the ovary. At this point, parental oxygen is no longer being supplied and the eggs will soon begin to die from anoxia if they remain in the ovary. Ovulation can be detected by applying slight pressure to the abdomen and observing free flowing eggs (no clumps) from the urogenital pore. If females are 20 pounds or larger, you can insert your small finger inside the urogenital opening and physically determine whether or not the eggs are still attached to the ovarian tissue. If no resistance is detected (a granular feeling), all the eggs should be loose in the ovary; the fish has completely ovulated (J. G. Boone, Maryland Department of Natural Resources, personal communication). This technique is not generally recommended as severe damage to ovarian tissue can occur. It is best to learn by experience to discern complete versus partial ovulation.



Immature eggs

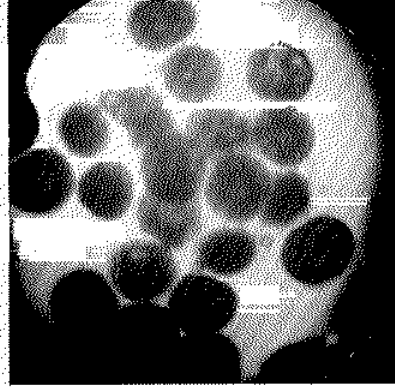

15 hours before ovulation



14 hours before ovulation

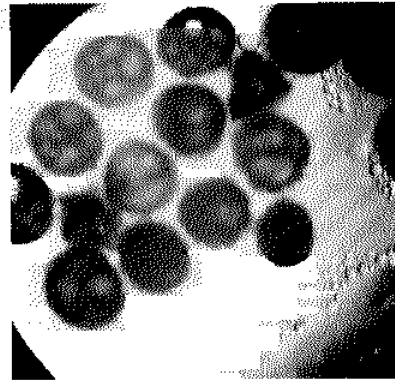

13 hours before ovulation



12 hours before ovulation

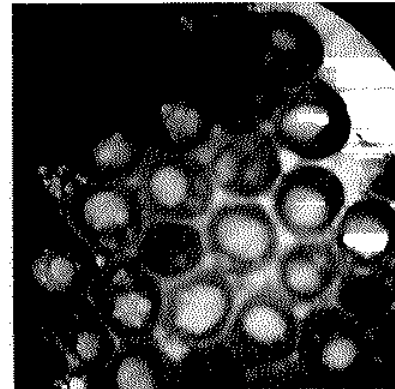

11 hours before ovulation

Figure 5.3. Egg development reference used in striped bass staging for predicting ovulation.
Photo credit: Jack D. Bayless.

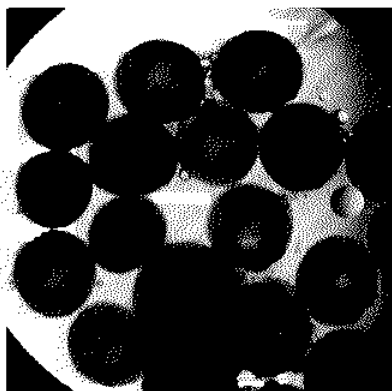

10 hours before ovulation; polarization complete

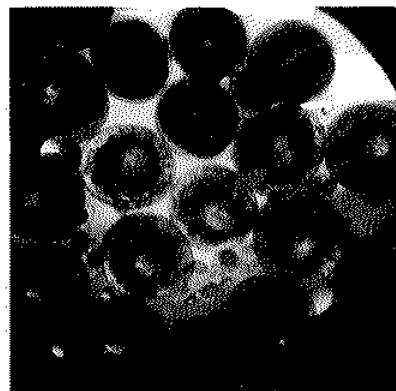

9 hours before ovulation; nucleus clearing

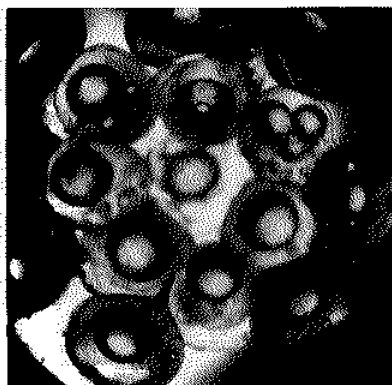

8 hours before ovulation

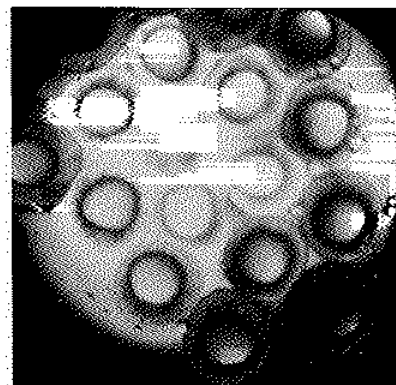

7 hours before ovulation

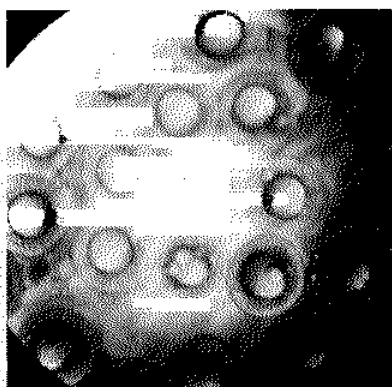

6 hours before ovulation

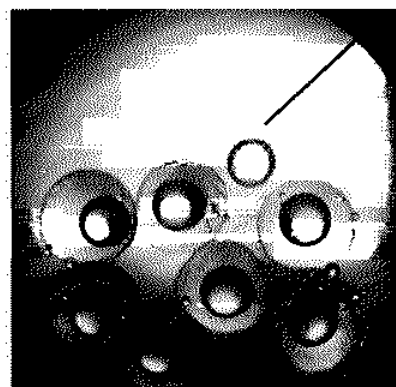

5 hours before ovulation

Figure 5.4. Egg development reference used in striped bass staging for predicting ovulation. Photo credit: Jack D. Bayless.

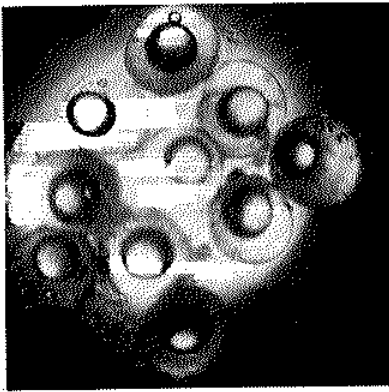

4 hours before ovulation

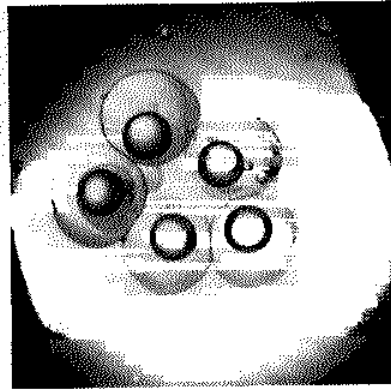

3 hours before ovulation

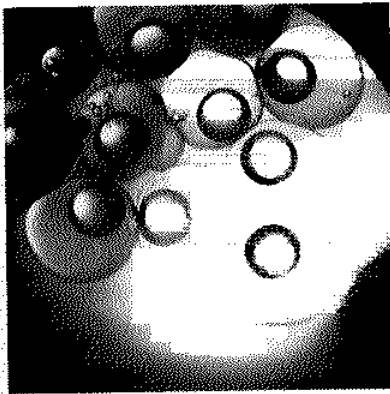

2 hours before ovulation

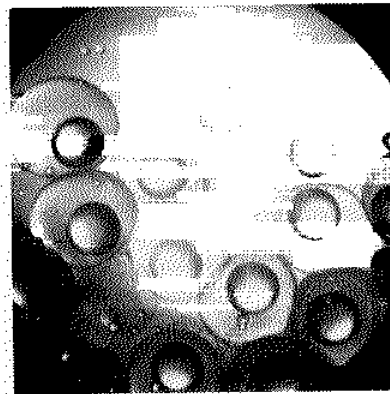

1 hour before ovulation

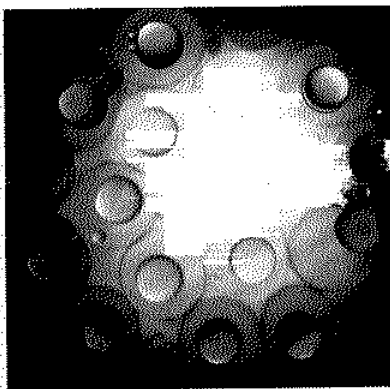

Ripe eggs at ovulation

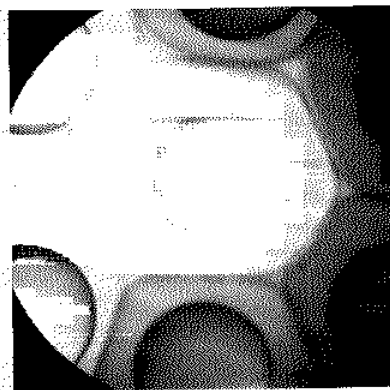

Ripe eggs at ovulation (50X)

Figure 5.5. Egg development reference used in striped bass staging for predicting ovulation.
Photo Credit: Jack D. Bayless.

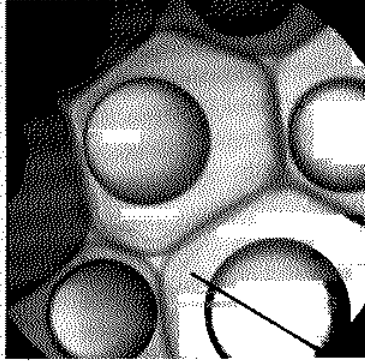

Overripe eggs 1 hour (50X); note breakdown at inner surface of chorion

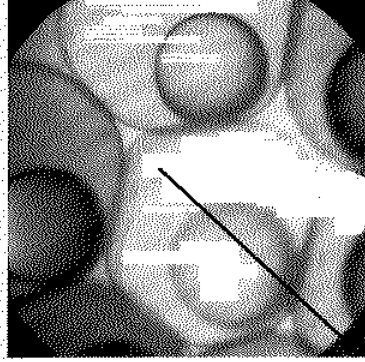

Overripe eggs 1.5 hours (50X); breakdown at inner surface of chorion persists

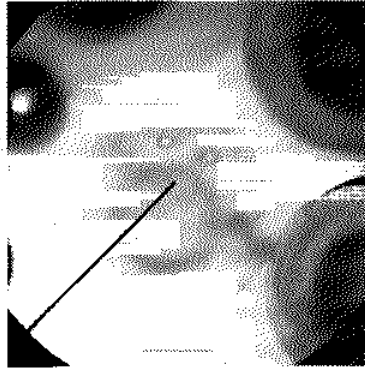

Overripe eggs, 2 hours (50X); note deterioration confined to one-half of egg

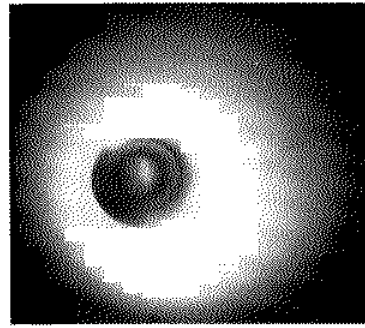

Overripe egg, 16 hours (20X); dark areas appear white under microscope

Figure 5.6. Egg development reference used in striped bass staging for predicting ovulation.
Photo Credit: Jack D. Bayless.

The culturist should notice the egg flow (or lack thereof) under slight pressure applied to the posterior, middle, and anterior portions of the abdomen. As previously stated, there appears to be a maximum of a one hour "grace" period after ovulation (Stevens 1967). However, Bayless (1972) felt that the optimum time period for egg removal was between 15 and 30 minutes after ovulation was first detected. Afterwards, the percentage of fertile eggs was inversely proportional to time.

Fertilization

Manual spawning of striped bass is quite simple and is accomplished fairly quickly. Typically it requires three people. One person strips the eggs from the female while the other two hold the fish, one each at the head and tail (Figure 5.7).

It is advisable to anesthetize the female before attempting to manually spawn her. An anesthetic (MS-222) can be added to the tank holding the female, or she can be removed to an aerated anesthetic tank which contains the proper amount of anesthesia. MS-222 can be used at a rate of 100 ppm to knock the fish completely out.



Figure 5.7. Strip spawning striped bass induced with hormones. Photo Credit: South Carolina Wildlife and Marine Resources Department.

Care should be taken when using MS-222 because it can cause pH shift when added to water if the water is not properly buffered. To balance against pH shifts, an equal weight of sodium bicarbonate can be added to the water when the MS-222 is added. To be certain pH is within the desired range, pH should be measured with a meter. Ideally, the pH should be 7.4 (C. V. Sullivan, North Carolina State University, personal communication). Further information on the use of fish anesthetics can be found in Randall and Hoar (1971).

After the fish is anesthetized, it should be picked up in a sling and dipped into a tank of fresh water to remove any remaining residues. Males are generally smaller than females and it is not necessary to anesthetize them for stripping, but it will make them easier to handle.

The dry or wet fertilization method can be used, although a modified dry method of fertilization appears to provide more consistent success. However, more than three individuals are required, because in the latter procedure, males are stripped simultaneously with the female and the semen is added to a luke-warm solution of slightly saline water (68-70°F and 3 ppt salinity). Several males are used. One or two males are stripped into the water, which is then added to the pan that contains the eggs. This process continues until the female is completely stripped. The procedure should be conducted quickly because the sperm are activated by water, and motility lasts only 30 to 60 seconds. After motility ceases, fertilization is unlikely to occur.

To increase genetic heterozygosity of offspring to be used for enhancement of natural populations (even as slight an increase as it may be), it is desirable to subdivide the eggs into four or more portions. Each portion is fertilized with one or more different males. Individual males should be used only once and released (see Chapter 11 for additional comments on genetic conservation). Another point of concern is the availability of males, because in many areas, males are abundant at the beginning of the spawning season and scarce toward the end. To circumvent the problem, males are often used more than once, and late in the season they are injected with HCG to stimulate semen flow. This practice can result in reduced genetic variability.

After the female has been completely stripped and the sperm added to the pan, water is added and the contents stirred by hand for 2-3 minutes to insure adequate mixing. Once activated by water, eggs remain fertile for only 2 minutes, so the procedure must be completed rapidly. After mixing, allow the eggs to settle for about 2 minutes, decant the water, and apportion the eggs in the incubation chambers (\approx 200 milliliters of non-floating freshly fertilized eggs per hatching jar, and 25,000 floating eggs per liter in circular or conical tanks).

Fertilization can be ascertained as early as 2 hours after spawning at 68°F. At this time, eggs should be in a 2-4 cell stage; however, percentages are more accurately determined 4-6 hours after fertilization (early blastula) when false or atypical cell division no longer confuses the issue. By now, it is easier to determine which eggs are progressing normally and which ones are obviously not fertilized. Cells of viable eggs will cleave in a uniform pattern (see

Figure 5.13), but unfertilized eggs and those with atypical fertilization will have unequal size and positioned cells.

Freshly fertilized eggs can be successfully transported with procedures similar to those used for fry (see below), but care should be taken to avoid shipping eggs 12-24 hours after fertilization. During this period, unfertilized eggs begin to break down, become covered with fungus, and are likely to cause water quality to deteriorate. Hatching in transit should also be avoided because break down of the egg shells can cause similar water quality problems.

Disposition of Brood Fish

Each hatchery has its own policy for handling brood fish. If brood stock are to be kept for future use, they should be prophylactically treated for disease and stress (see Chapter 13). The hatchery manager should remember that for fish anesthetized with MS-222 there is a 21-day withdrawal time before they should be eaten. If fish are to be released into the wild, they should be treated prophylactically.

Incubation

Estimating Numbers of Eggs and Fry

There are various methods for estimating the numbers of striped bass eggs. Stevens (1967) weighed eggs from each female and calculated the number of eggs on the basis of 25,000 per ounce (400,000/pound). This index was developed by estimating the number of eggs in 6-ounce samples from four different females. The number of eggs in each sample was estimated volumetrically from von Bayer's (1910) table. Bayless (1972) also used volumetric measurements one minute after fertilization, and determined that 100,000 eggs displaced an average volume of 149 milliliters, based on eggs 1.2 mm in diameter. Although fairly wide variations sometime occur, unfertilized eggs from South Carolina striped bass average about 1,000/milliliters (J. H. Kerby, U.S. Fish and Wildlife Service, personal communication).

The volume of an egg increases rapidly after immersion in water, so estimations should be made immediately. Because the rate of volumetric increase and the time required for fertilization and decanting excess water varies with each group of eggs, the following procedures are recommended as a guideline for determining accurate estimations of eggs: (Note: this procedure was taken from Bonn et al. (1976) for use in hatching jars and has been modified and improved).

- (1) Hatching jars should be individually calibrated and marked at 100-milliliter intervals with the shad tubes (the tube within a tube configuration, Figure 2.1) inserted.
- (2) Spawn fish, fertilize, decant excess water, and place the eggs into an appropriate incubator as previously described. Be sure to plug the aquarium or tank.

(3) Three hours after fertilization, after the eggs have water hardened, take equal samples of eggs from several jars with a glass tube and place in a graduated cylinder (≈ 10 milliliters total). Turn off water to every jar after sampling and allow the eggs to completely settle. Record the volume of water-hardened eggs from calibration markings on side of each jar and the volume of the sample. Turn the water back on and adjust flows.

(4) Dye the sample of eggs by adding a small amount (≈ 0.1 g) of potassium permanganate (KMnO_4). Pour the dyed eggs onto a fine mesh screen and wash thoroughly to remove excess KMnO_4 . Place the eggs in a light colored background container (e.g., white dish pan) for improved visibility. The container should have about 2 liters of water. Hand-count the eggs as they are siphoned from the container. Divide that number by the sample size and determine the number of eggs per milliliter.

(5) Multiply the number of eggs per milliliter (calculated from the sample) times the total volume of eggs incubating to obtain the total number of eggs.

(6) If the number of live eggs trapped in the aquarium are abundant enough to warrant saving, remove them by dipping or by pulling the drain plug and allowing them to collect into a catch chamber. Then place the eggs into a hatching jar.

(7) In tanks where floating eggs are placed, take a sample, determine the number of eggs per liter, then multiply times the number of liters in the tank (excluding volume within the screen).

(8) Four to six hours after fertilization, take a sample of 300-500 eggs from the incubation containers and determine percent fertilization. Multiply this percentage times the total number of eggs incubating to determine the total number of viable eggs incubating.

(9) Remove the drain plug from the aquarium and allow the dead eggs to escape.

(10) Two to six hours before anticipated time of hatch, repeat procedures outlined in items 3, 4, 5, and 7 with embryos. Examine them under a microscope and determine the percentage that appear to have normal development. Multiply that percentage times the number of embryos calculated per milliliter and obtain a total number of viable fry.

This will be the final number calculated unless something happens to abort the hatch.

Estimating numbers of eggs from white bass. White bass eggs at ovulation are about one-half the diameter of striped bass eggs, usually 0.61-0.68 mm (Bayless 1972). They are adhesive, demersal, and increase little in diameter when water-hardened. The number of eggs being incubated can be estimated based on the weight of the eggs from each female at spawning or by using the same technique outlined above. If the latter is used, special care must be taken to accurately determine the volumes of eggs incubating, because a small error can result in

significant differences between actual and estimated numbers (see Chapter 11 for more details on spawning white bass).

Recently, in Georgia, three 1-g samples of unfertilized eggs were counted from striped bass, hybrid bass, and white bass (R. A. Rees, unpublished data). The expanded data yield the following average number of eggs: striped bass, 25,004/ounce; striped bass x white bass hybrid, 52,503/ounce; white bass, 107,955/ounce.

Incubation Equipment

Hatching jars. Hatching jars are the most commonly used equipment for incubating striped bass eggs. These jars are described in Chapter 2.

We recommend incubation of 100,000-150,000 fertilized striped bass eggs per jar (\approx 200 milliliters of eggs/jar) (Figure 5.8). Water circulation through the hatching jar must be sufficient to "roll" all the eggs, and keep them moving. During the first 2 hours of incubation, egg buoyancy increases dramatically as they water-harden. To avoid flushing eggs from the jars, proper flow rates must be maintained (requiring constant vigilance) throughout the entire incubation period, but the first 2 hours are the most important. Although hatching jars provide the best way to incubate eggs that are negatively buoyant, they also require the most labor. For this reason, many culturists have changed to less labor-intensive methods, such as tank spawning. (See Chapter 6 for further details.)

Incubation of white bass eggs in hatching jars can be difficult because the eggs are adhesive. However, a procedure has been developed that eliminates the adhesiveness and allows normal incubation, (see Chapter 11).

Spawning tanks. Spawning tanks are commonly used for spawning and incubation of *Morone* eggs. The size of the tank depends on the size of the females. Tank diameters range from 6 feet to 12 feet and are generally 30-42 inches deep. Methods for tank spawning are discussed in Chapter 6.

Aquaria or troughs. Aquaria or troughs are sometimes used to incubate striped bass eggs. Small tanks (20-50 gallons) are commonly used for eggs that have large oil globules and float (e.g., Chesapeake Bay eggs) (Figure 5.9). Use of aquaria or troughs is often initiated when hatching jars are all in use and emergency incubation capabilities are required, or this method can be used in lieu of hatching jars. The aquarium or trough is set up as if to hold fry. The best technique provides a water supply through a horizontal PVC pipe along the center of the bottom. The pipe should run the full length and have perforations on the sides and top to provide sufficient current to keep the eggs rolling. A standpipe and air ("bubble") curtain around the screen will allow a minimum flow rate of 1 gallon per minute. The required flow rate will vary with the size of the container and egg buoyancy. Flow rates should be carefully regulated to prevent rolling the eggs too hard, which can damage them. If tanks are used for floating eggs, a screen around the outlet pipe and an air curtain to keep the eggs off of the screen are required (Figure 5.9).



Figure 5.8. Eggs incubating in jars. Photo Credit: Alabama Department of Conservation and Natural Resources.



Figure 5.9. Striped bass egg incubation tanks used for floating eggs. Photo Credit: Maryland Department of Natural Resources.

There are advantages and disadvantages to this method of incubation. Use for incubating floating eggs is the most obvious. Additionally, fertilized eggs can be incubated and hatched in a single tank in quantities that need not be moved until the fry are ready to be stocked. Less space and constant attention are required during incubation.

One disadvantage is the difficulty in removing dead eggs during incubation. Usually if the air and water flow to the aquarium or trough are turned off, the good eggs will settle to the bottom and the dead eggs will float. Separation takes about 10 minutes. Dead eggs can be siphoned or skimmed off and the air and water restored. The process must be completed within 15-20 minutes to prevent egg suffocation. Several separations may be necessary before removal is complete.

Removal of dead eggs is also difficult when all eggs float (e.g., Chesapeake Bay eggs) because it is difficult to separate dead and live eggs. If water and air are turned off as discussed above, the dead eggs will usually be in the upper-most layer (Figure 5.10). The tank should have a drain valve that can be closed. Turn the water off, close the drain valve, and remove the screen from around the standpipe and allow the eggs to settle. Open the drain valve and turn the water on at a very low flow to flush most dead eggs into the drain and retain the live eggs in the tank. Care must be taken because both dead and live eggs can easily be flushed if the flow is too great. After a few minutes, turn the water off, close the drain, replace the screen around the standpipe, open the drain, and adjust the water flow.

Another disadvantage is the excess oil which accumulates from dead eggs as disintegration occurs; this is especially true of eggs that float. The oily film can be removed by gently floating wax paper or polypropylene oil absorbency cloths (Figure 5.11) (see Appendix B), followed by gently removing the paper or cloth.

Finally, dead egg decomposition and the length of time in the incubation containers increases the opportunity for fungal growth, which often traps and kills healthy eggs or fry. There is no easy solution to the problem. Sterilization of containers before and after use, and frequent removal of fungus by suction or picking during incubation and subsequent hatch should minimize the problem. In some situations, potassium permanganate and salt have been effective treatments for fungus (see Chapter 13).

Incubation Time and Temperature

Time required for striped bass eggs to hatch depends on water temperature. Temperatures of 62 and 65°F result in incubation periods of about 56 and 48 hours, respectively. Expected time for incubation at various temperatures was summarized by Bayless (1972) and is presented in Figure 5.12.

Water temperatures for white bass eggs should range from 64-68°F. Incubation time at this temperature usually requires about 43 hours for the eggs to begin hatching. White bass eggs may take 24 hours from the time hatching begins until all hatch. Incubation for hybrid eggs will be similar to those for the female parent.

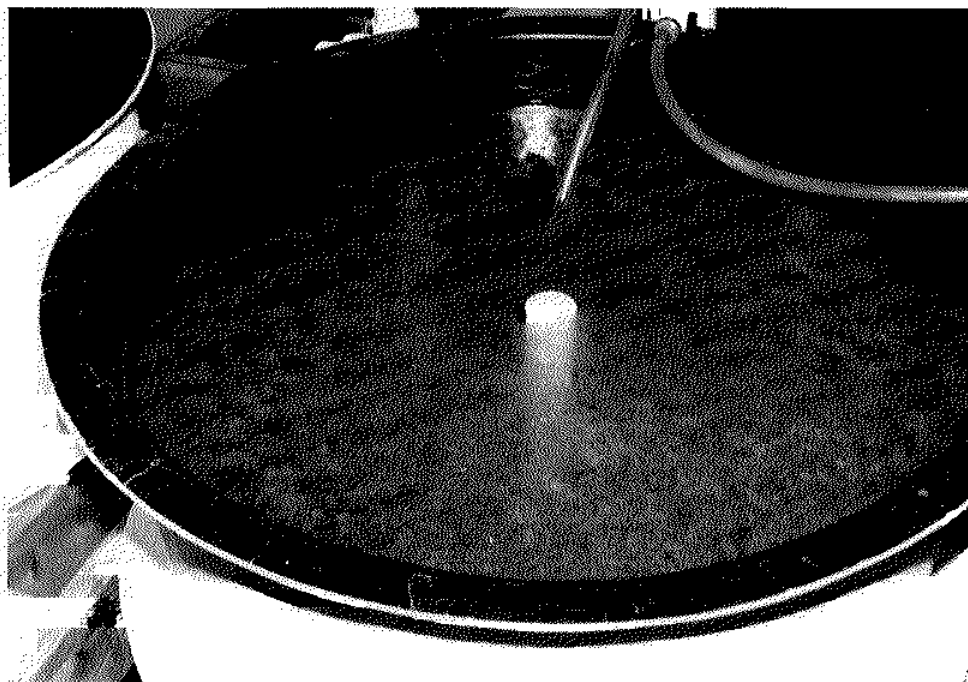

Figure 5.10. Dead striped bass eggs on surface of hatching tank. Photo Credit: Maryland Department of Natural Resources.

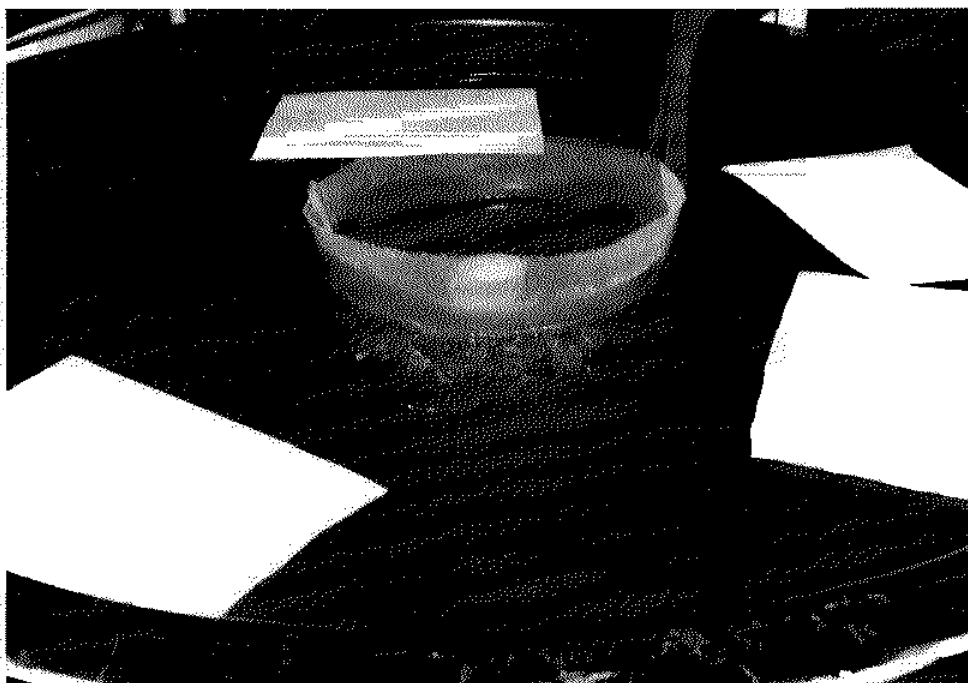

Figure 5.11. Oil absorbency cloths on tank surface used with striped bass eggs with high lipid content. Photo Credit: Maryland Department of Natural Resources.

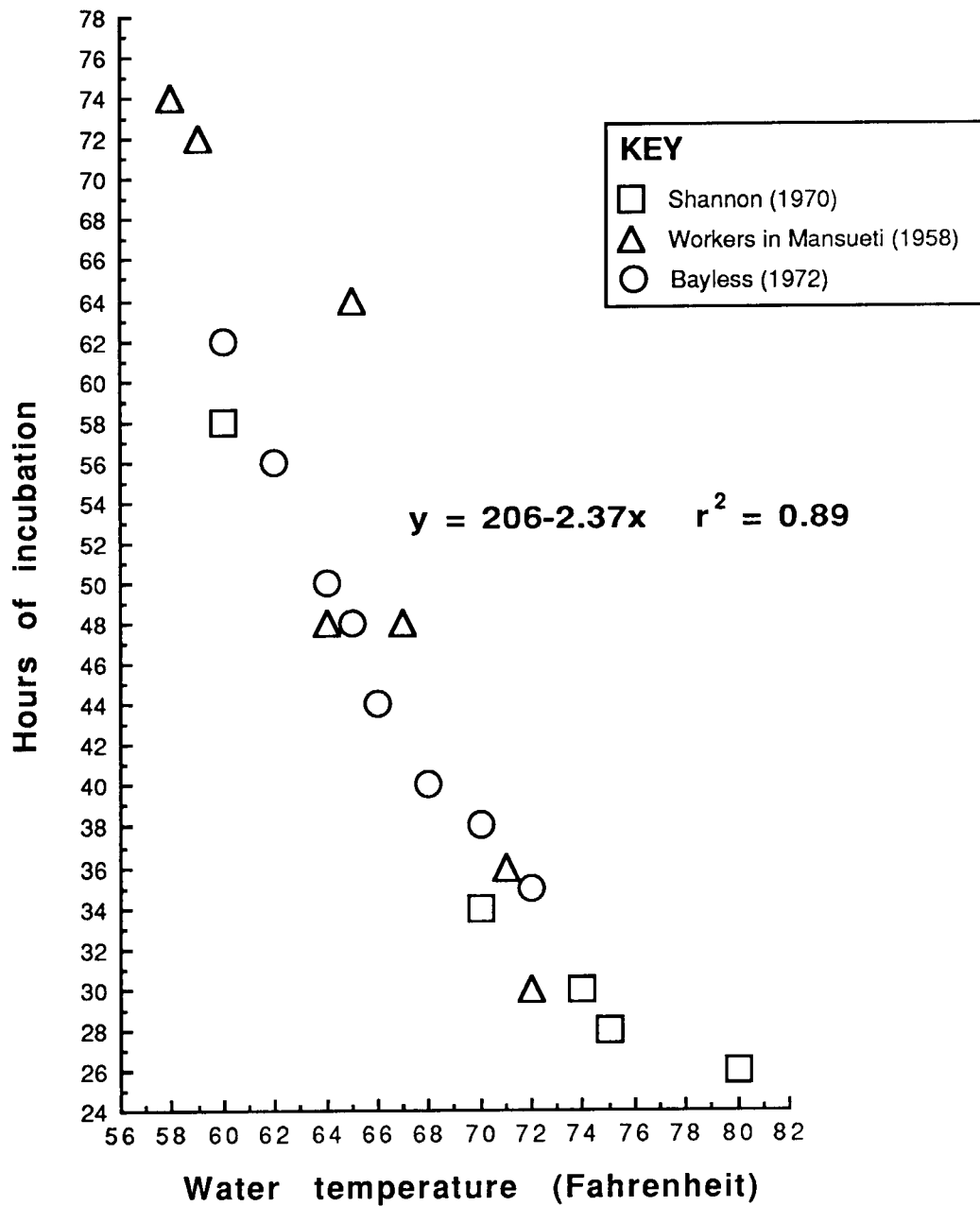

Figure 5.12. Time versus temperature graph for hatching striped bass eggs. Regression formula was calculated from original references. Adapted from Bayless (1972).

Incubation Considerations

Striped bass eggs usually water-harden within 2.5 hours post-fertilization, depending on water hardness. During this period, the chorion absorbs water and the egg expands from approximately 1.2 mm to as much as 4.2 mm, again depending on hardness and salinity of the water. White bass eggs expand only slightly during water-hardening. According to Bayless (1972), white bass eggs with a mean diameter of 0.64 mm at ovulation water-hardened to a 0.73 mm mean diameter (water hardness was equal to 120 ppm as CaCO₃).

Dead and unfertilized striped bass eggs all turn opaque between 12 and 18 hours post-fertilization. If eggs are incubated in hatching jars, dead eggs usually float out or layer on top of the live eggs, and they can be carefully siphoned from the jars. Dead eggs which flow into the aquarium can be siphoned or, before hatch, drained by removing the drain plug. Remember to replace the drain plug before the eggs hatching.

Descriptions and photographs (Bayless 1972) of striped bass egg development at 66°F are presented in Figures 5.13-5.16. As the eggs develop, a darkening of the animal pole of the egg can be seen by 24 hours. This area is the embryonic shield and the neural fold of the future embryo. The developing larva (embryo) can be seen without magnification about 30 hours after fertilization.

In contrast, white bass eggs are almost opaque, so embryonic development is difficult to observe before hatching, but they can be treated to clear the egg (see Chapter 11).

After the embryos hatch, they are termed prolarvae, sac fry, or fry. At this time, jars should be positioned over the aquaria so the fry can "swim-up" over the lip of the jar into the aquarium. Water flow must be sufficient to assist in the swim-up process. Deformed fry (Figure 5.17) stay near the bottom of the jars and can be observed swimming erratically. After the majority of the normal fry have left the jar, the remaining deformed fry should be discarded.

Deformed sac fry cannot be as readily observed in trough or tank incubation. However, these fry often die during the holding period and are not usually considered a serious problem unless they represent a large percentage of the total fry hatched. For this reason, it is critical to estimate deformity before hatch begins to avoid overestimating the numbers suitable for stocking.

Holding and Feeding Fry

Whenever possible many culturists stock fry in ponds as soon as they begin feeding. However, if you wish to be sure of air bladder inflation or want to be sure the fry are feeding before stocking, then they must be held and fed an appropriate food item for a number of days.

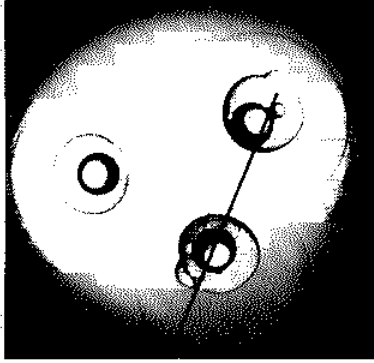

Unfertilized egg, 2 hours (20X); no cell division

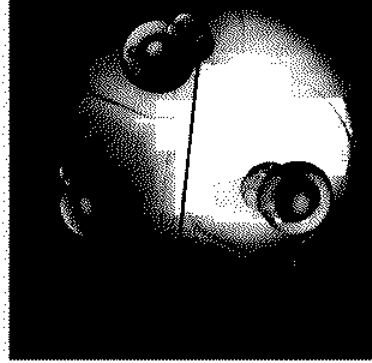

Fertilized egg, 2 hours (20X); note cleavage

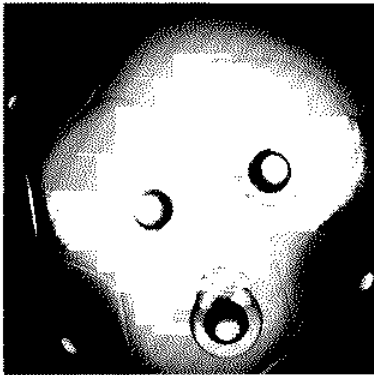

3 hours (20X)



4 hours (50X)

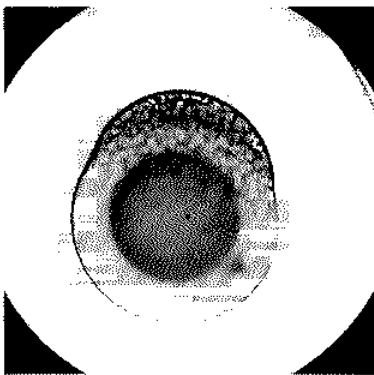

5 hours (50X)

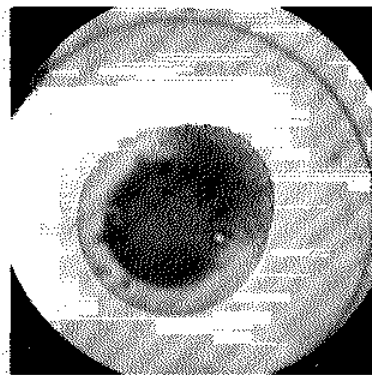

6 hours (50X)

Figure 5.13. Striped bass egg and embryo development at 66°F. Photo Credit: Jack D. Bayless.

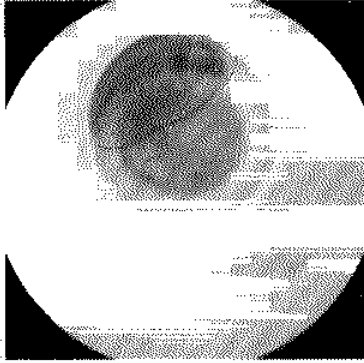

10 hours; note germ ring

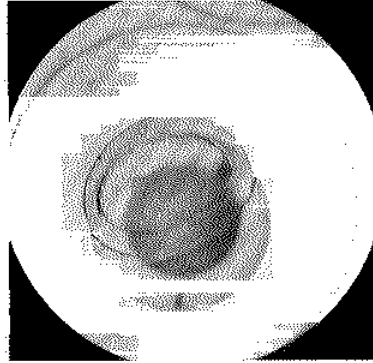

12 hours

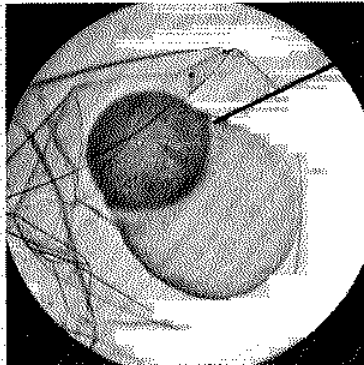

16 hours, lateral view; chorion ruptured

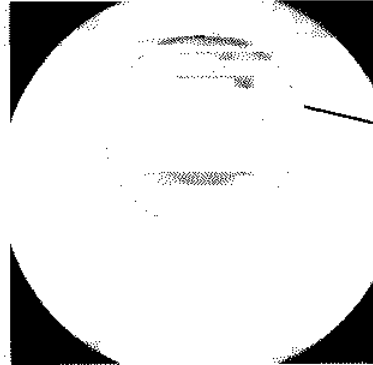

18 hours; arrow shows ventral fold

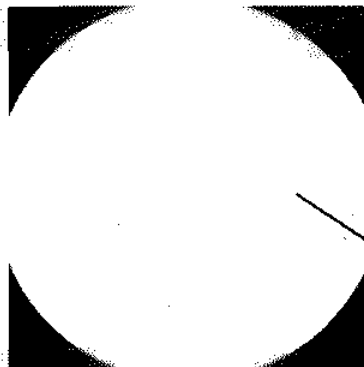

19 hours; embryo outline

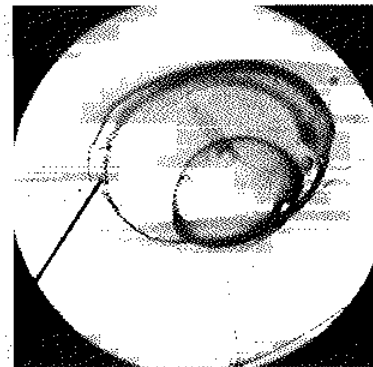

20 hours, lateral view

Figure 5.14. Striped bass egg and embryo development at 66°F (magnification 50X). Photo Credit: Jack D. Bayless.

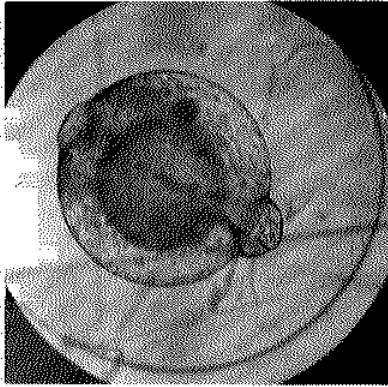

22 hours

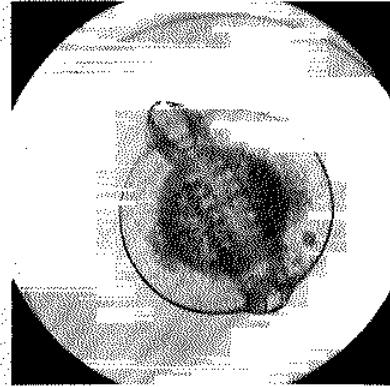

24 hours

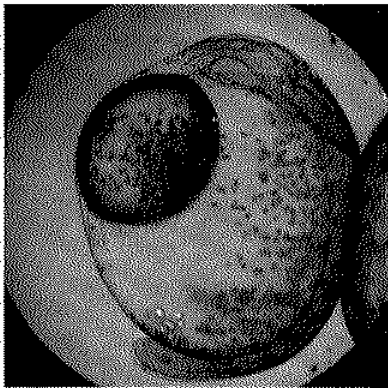

26 hours

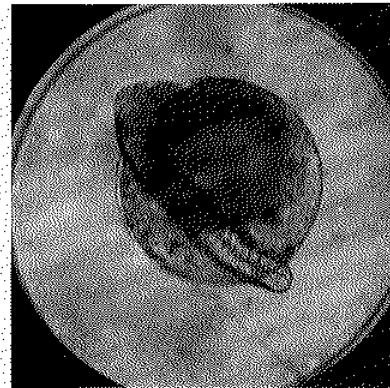

28 hours



30 hours

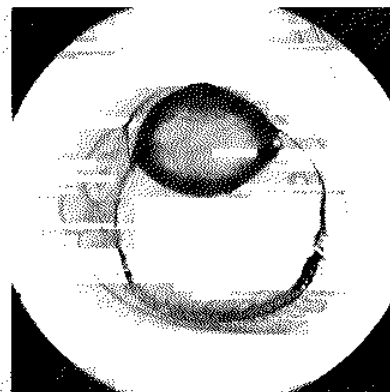

33 hours; lateral view; chorion ruptured

Figure 5.15. Striped bass egg and embryo development at 66°F (magnification 50X). Photo Credit: Jack D. Bayless.



35 hours

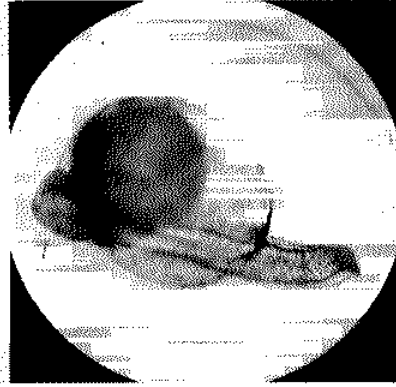

37 hours

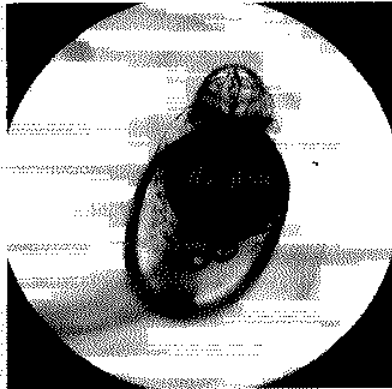

43 hours



44 hours

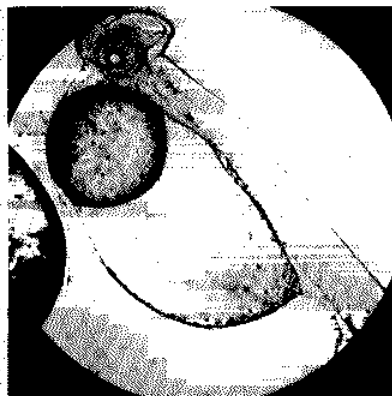

18 hours post-hatch



24 hours post-hatch

Figure 5.16. Striped bass egg and embryo development at 66°F (magnification 50X). Photo Credit: Jack D. Bayless.

Fry Holding Facilities and Fry Density

Sac fry (1-4 days old) can be held in any type of container (non-toxic) as long as water flow is sufficient to keep them suspended. By the second day, fry can maintain themselves in the water column. Common holding facilities include aquaria, troughs, or circular tanks. Aquaria (30-75 gallons) are commonly used because fry can be easily observed.

Bonn et al. (1976) stated that up to 1,500,000 sac fry can be held in a 30-gallon aquarium (50,000/gallon) if the water exchange is 1 gallon/minute. Most culturists prefer a lower concentration due to the potential of fry mortality from system malfunctions. Fry densities in troughs and circular tanks also depend on the water exchange rate and the culturist's density preference, although holding facility availability may dictate the fry density, especially if space is limited. Fry, 7 days old and older, should be held at low densities (1,000-2,000 fry per gallon).

Because exposure of fry to direct sunlight can cause mortality (Rees and Cook 1985a), placement of fry holding facilities near windows and doors should be avoided. Interior lighting should be kept minimal; incandescent lights are preferred over fluorescent lights. Interiors of holding vessels should be a dark color and painted with a marine lead-free epoxy paint or, if fiber-glassed, should have a dark gel coat finish. Dark colors appear to reduce stress and cannibalism.

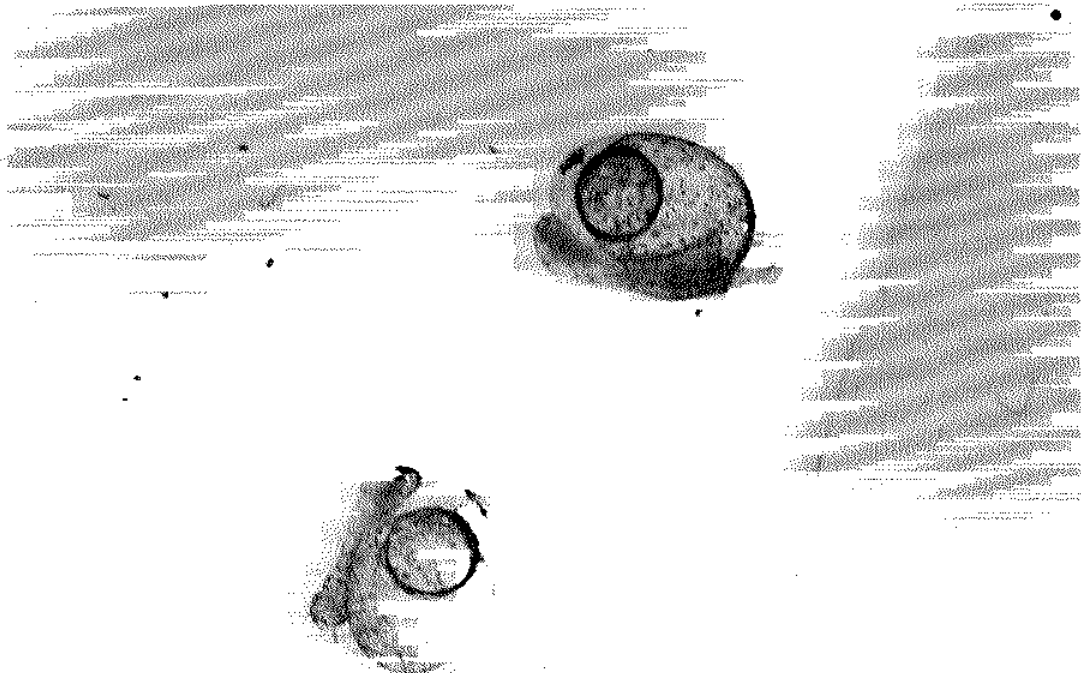

Figure 5.17. Deformed striped bass fry exhibiting scoliosis and truncation. Photo Credit: South Carolina Wildlife and Marine Resources Department.

Fry Development

Newly hatched fry have incomplete mouth parts, depend on their yolk sac for nourishment, and cannot swim well. Water currents are required to keep them from settling to the bottom and suffocating, especially during the first 24 hours. When they are 4 days old, they can swim horizontally against minor currents. At 66°F, 5-day old striped bass and palmetto bass (striped bass x white bass) have functional mouth parts, a complete gut, and are capable of accepting feed. Mortality due to inferior or deformed fry usually occur within the first 5 days after hatch. Feeding should be initiated before day 7.

Sunshine bass (white bass x striped bass) fry have functional mouth parts and a complete gut on the fourth day at 66°F. They are approximately two-thirds the size of striped bass or palmetto bass.

Fry Feeding

Feeding striped bass or palmetto bass at specific intervals is necessary for fry health and growth. Specifics are provided in Chapter 10.

In general, live brine shrimp nauplii (*Artemia* spp.) are the most common food for striped bass or palmetto bass fry held in tanks beyond 5 days. However, brine shrimp vary in critical nutritional compounds such as highly unsaturated fatty acids (HUFAs) and care should be taken to either supplement HUFAs or purchase brine shrimp strains that contain some HUFA. Other, less used foods include frozen brine shrimp, live zooplankton, and artificial feeds. Artificial feeds are not recommended at this time because they are poorly utilized and promote rapid water deterioration.

White bass and sunshine bass fry are too small to consume brine shrimp nauplii. Therefore, live zooplankton (particularly rotifers) are fed, if fry are held in tanks, or they are normally stocked in rearing ponds when they are 4 days old.

Pathogen Control

Uneaten food, dead fry, fungus, and other debris should be removed from the fry holding vessels by siphoning, dipping or picking. Sterilizing holding containers between crops with Roccal[®], surgical soap, and salt will help retard growth of fungus and bacterial buildups (see Chapters 12 and 13 for stress prevention and disease control).

Fry Shipping

Estimation of Fry Numbers

Volumetric sampling of each aquarium, tank, or trough is recommended for estimating the number of fry. The procedure works best if the fry are less than 3 days old because they are less able to avoid capture, but it will work with fry up to 7 days old if the water in the holding vessel is stirred constantly during sampling. The air and water supply are turned off and the holding water is adjusted to a desired volume. Water is gently stirred to achieve a uniform distribution of fry. A glass tube (i.e., 0.5 inches inside diameter) is rapidly inserted (vertically) to

the bottom of the holding container, the tube is stoppered to create a vacuum, the sample is withdrawn, and the volume is measured in a graduated cylinder. Depending on fry density and holding container size, between 5 and 20 samples are collected from each container, and the fry in each sample are counted. The highest and lowest samples are discarded and the remaining sample counts are averaged. The number of fry per container is calculated by multiplying the volume in milliliters by the average number of fry/milliliters in the sample. The greater the number of samples taken from each container, the more accurate the fry estimation will be. Immediately after the samples are collected, refill the container and turn on the air.

Another method involves taking samples with a beaker, graduated cylinder, or other container with a known volume, rather than a tube. A larger container (e.g., 1-L beaker) may provide more accurate results for older fry because of possible escapement from the smaller diameter tube.

Shipping Procedures

Larvae are concentrated within the holding container by siphoning or draining through the screen. Plastic bags are placed into styrofoam boxes. Larvae are then dipped out, drained, or poured from the container into the plastic shipping bags (Figure 5.18). Additional water may be added to the bag as necessary. The amount of fry and water per bag depends on the distance and transportation method. Shipment by air is usually done with water 5-6 inches deep to minimize weight. Other methods of transportation, where weight is not a problem, allow the shipper to fill the bag, up to one-half the volume of the box, with water. Oxygen is added to the bag to fill the remaining volume of the box. Each bag is sealed by twisting and folding the top of the bag and applying two castration bands (Figure 5.18), or by using several heavy duty rubber bands or vinyl electrical tape. Fry shipped by aircraft should be double bagged, with each plastic bag sealed separately. Double bagging helps prevent them from bursting due to pressure differentials during flight. The top of the box is then taped down securely and the fry are ready to ship. Avoid direct sunlight when packing fry for shipment.

Larvae can be held in oxygenated shipping containers for up to 48 hours at 100,000 fry/container with 2.5 gallons of water; however, the recommended packing density for fry transportation over 8 hours is 50,000 fry per container. For transportation times less than 8 hours, up to 100,000 fry per container can be safely shipped. Fry can be shipped at 1 day of age, but most are usually older (5-7 days), and fry over 7 days old should be shipped at the lower densities. Shipping containers should not remain completely stationary for prolonged periods, as this can contribute to suffocation. Water temperature in the bag should remain between 60 and 70°F. Ice cubes can be distributed around the outside of the bag and in each corner of the box during warm weather to prevent harmful temperature increases. Water temperature in shipping boxes ranged between 15.2 and 18.3°C for 24 hours with 200 g of cubed ice placed on the outside of the bag and the box sealed (air temperature = 24°C; initial water temperature = 16°C); crushed ice at twice the amount had no cooling effect (R. M. Harrell, unpublished data). Too much ice can drastically drop the temperature, so care should be exercised in its use.

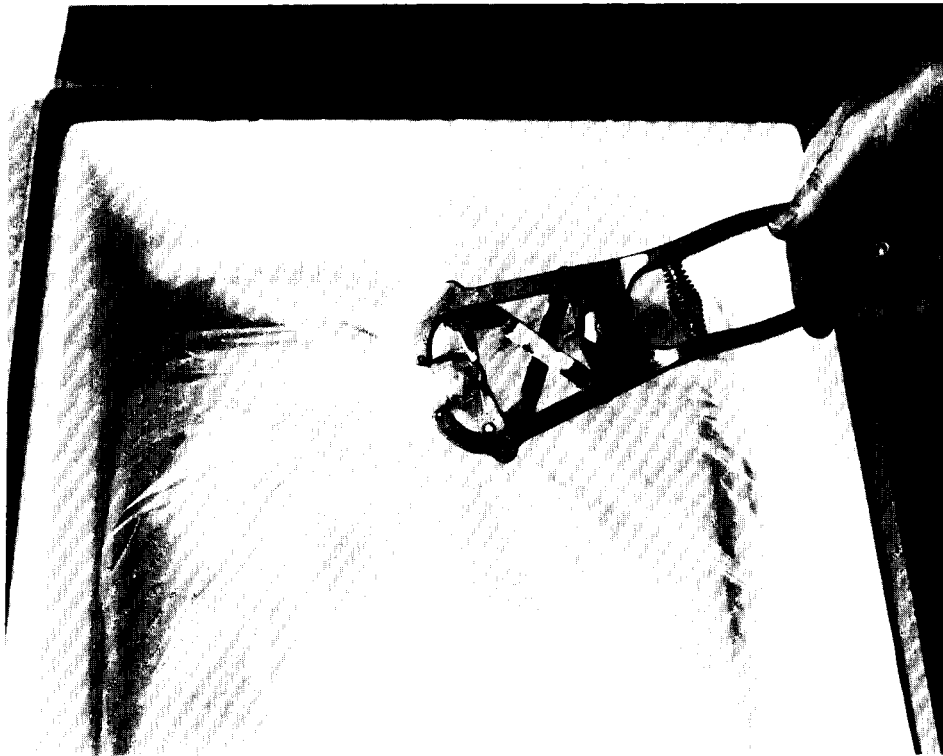
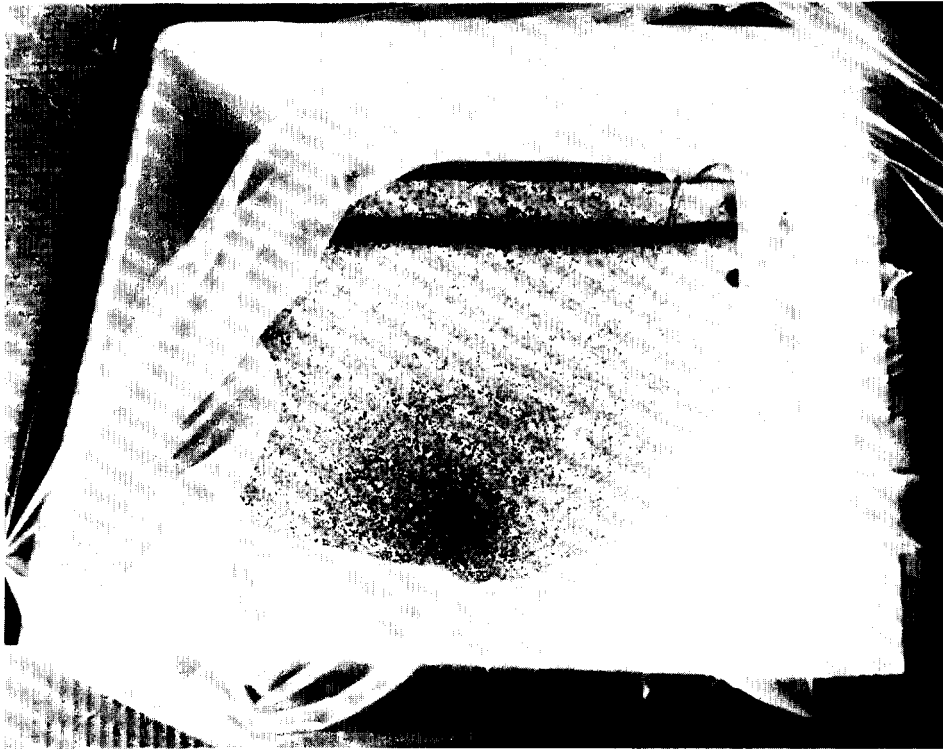

Figure 5.18. Shipping striped bass fry in plastic bags which are charged with pressurized oxygen and sealed. Photo Credit: Reginal M. Harrell.

Tank Spawning Methodology for the Production of Striped Bass

James M. Smith and David K. Whitehurst

The method for tank spawning striped bass (*Morone saxatilis*) was first described by Bishop (1975). It evolved after hormone-injected striped bass that were being held for manual stripping spawned in a circular holding tank. The tank spawning method, based on the results of Bishop and others, is now used at several striped bass hatcheries.

The design of a striped bass hatchery using this technique is discussed in Chapter 2. A few modifications from the basic jar hatchery design are necessary if the tank spawning method is to be used, but considerably more space is required to hatch an equivalent number of eggs.

The water source, volume, and delivery system of a hatchery dictate the feasibility of tank spawning. Large volumes of water are necessary for successful results, and the economics of delivering such quantities of water can determine whether or not tank spawning should be considered.

Advantages and Disadvantages

Tank spawning has advantages and disadvantages when compared to jar culture (Bishop 1975; Kerby 1986). First, it is significantly less labor intensive than jar culture. Bishop (1975) reported that the number of person-days required to produce the same number of fry by tank spawning was reduced by half when compared with jar culture. Secondly, tank spawning does not require the expertise in predicting ovulation time of the female unless hybrids are needed. Because female brood fish spawn naturally, complete ovulation usually occurs and results in a more complete spawn and better fertilization rates. Bishop (1975) also reported that fertilization of eggs from tank spawning usually approximated those levels obtained using naturally ripe brood fish. Due to these factors, tank spawning provides more efficient utilization of brood fish in areas where the supply is limited. Finally, brood fish are generally in better post-spawn condition and can be returned to the wild or holding ponds for future use. Males can also be reused for subsequent spawning if necessary (see comments in Chapters 5 and 11 on reuse of males).

Disadvantages include the large space requirements necessary in a production operation, the costs of constructing the facility, and the large volumes of water required. In addition, the culturist has less control over the developing eggs and larvae than in the jar incubation method, and hybrids cannot be produced naturally because it has not been demonstrated that female striped bass release their eggs in the presence of males of other species.

Although tank spawning may not be a viable option for all hatcheries, it should be considered by any culturist initiating a striped bass culture operation. The advantages can far outweigh the disadvantages in some situations.

Spawning Tanks

Many types, sizes, and diameters of tanks have been successfully used. Fiberglass tanks have provided the best results, but are the generally the most expensive. Modified galvanized stock tanks are also commonly used. Bishop (1975) reported that 6-foot diameter tanks, 30 inches deep (Frigid Unit® model RT 630), were the most desirable. If brood fish in excess of 35 pounds are to be used, 8-foot diameter tanks will provide better results. Holding tanks should be indoors to eliminate direct sunlight, control temperatures, and reduce extraneous noise.

Water delivery to the tanks should be by two or more rigid tubes, 0.5 inches in diameter. These should be located about 8 inches inside the tank and set at a 15° descending angle to the water surface. A flow rate of 8 to 10 gallons/minute in a 6-foot tank will provide the desired circular velocity of 4 to 6 inches/second. This velocity will maintain striped bass eggs and fry in suspension during development. Standpipe height should allow at least 4 inches of freeboard to the top of the tank to discourage brood fish escape (see Figure 2.3).

A cylindrical screen encircling the standpipe will prevent egg and fry loss during incubation. The screen should be 15 to 18 inches in diameter and several inches higher than the standpipe. Screens with too little surface area can become clogged with egg shells and debris. Bishop (1975) described a screen constructed of plywood discs and wooden struts which was covered with stainless steel screen. Openings can also be cut in fiberglass or PVC pipe of appropriate diameters and screened (see Figure 2.4). Fiberglass and PVC screen supports generally do not need to be weighted to hold them in place. However, it is prudent to anchor the screens somehow to the bottom because active fish, during the spawning process, can easily move a PVC screen. In addition to stainless steel screen, other materials such as saran or nitex can be used as screens. Mesh size should be 500 µm or smaller (200 µm for eggs from white bass (*M. chrysops*) or white perch (*M. americana*) to prevent fry escapement. Hot melt glue or silicone sealant can be used to attach most screen material to wood, fiberglass, or PVC frames. It may be necessary to attach foam rubber rings to the bottom of the spawning screen as a gasket to prevent egg and fry loss. The top of the spawning screen should have an opening to allow removal of the standpipe without removing the spawning screen and vice versa (Figure 6.1).

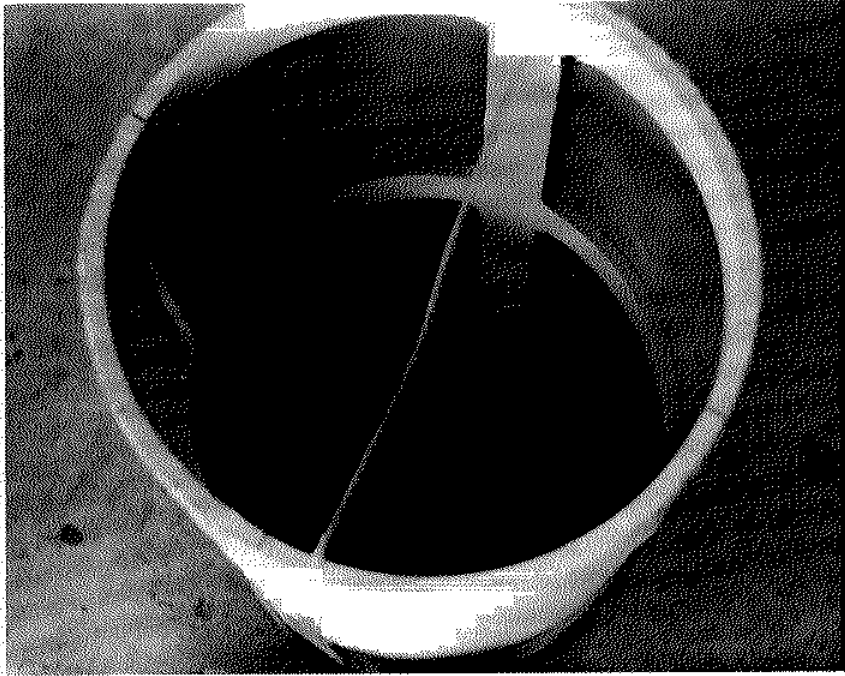

Figure 6.1. Screen surrounding standpipe which allows access to standpipe for removal. Photo Credit: Tennessee Wildlife Resources Agency.

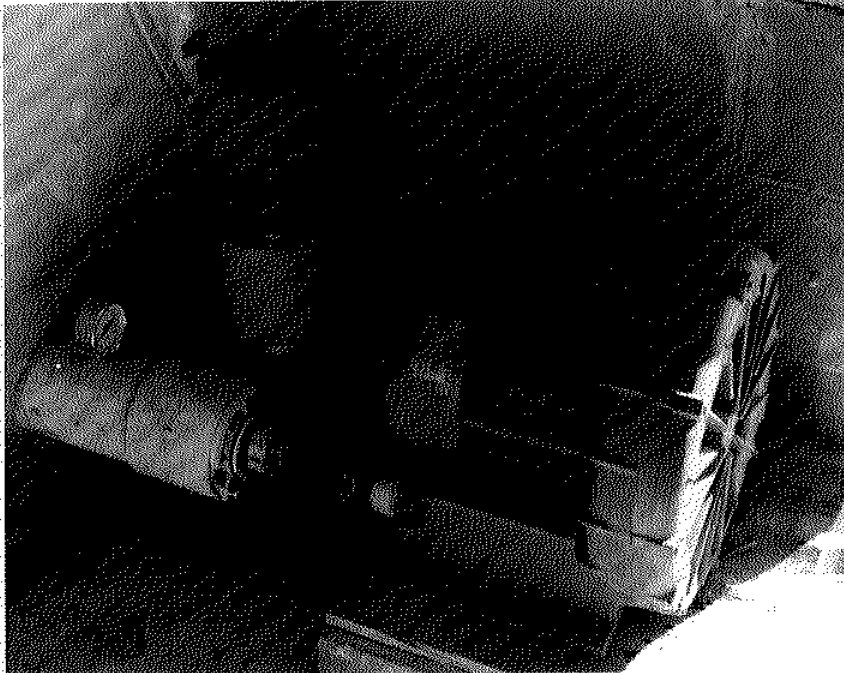

Figure 6.2. A horizontal shaft regenerative blower with a screened intake (1), a pressure gauge (2), and a large delivery pipe (3) necessary to reduce back pressure and minimize friction losses. Photo Credit: Nick C. Parker.

A perforated air line should be placed at the base of the spawning screen to form a bubble curtain to prevent impingement of eggs or fry, and to enhance egg suspension. Flexible plastic tubing, 1/8-inch diameter, with holes at approximately 2-inch intervals will provide a sufficient bubble curtain. Small, portable air pumps can be used for individual tanks, or a high volume, low pressure regenerative blower can be used to supply the whole system (Figure 6.2). Air pressure should be sufficient to provide an adequate curtain of small bubbles around the perimeter of the screen at a depth of 30 inches.

Brood Fish

Brood fish collection is discussed in Chapter 4. After capture, brood fish are injected intramuscularly with human chorionic gonadotropin as described by Bayless (1972) (see Chapter 5 for specific details and recommended doses) either before or after transport to the hatchery. Both sexes must be injected in order to obtain a successful spawn. Brood fish can be placed directly into spawning tanks after injection. Generally, one female is placed in each spawning tank with one or two males, and if two females are placed in a spawning tank, there should be two to four males in the tank. Disturbances should be avoided or minimized after brood fish are in the tanks. Spawning activity is improved when little or no lighting is present. If a closed water system is used, an inert dye can be used to shade the water and reduce light intensity. Spawning tanks should never be placed in direct sunlight.

Pre-spawning behavior in spawning tanks often includes aggressive courtship of females by males, including bumping and "observation" of the female's vent area by the male. A rapid series of direction changes by the female usually indicates ovulation and readiness to spawn. Spawning activity usually takes place on the surface, as described by Bishop (1975), and can be observed from a distance. Verification of spawning in murky or unfiltered systems can be accomplished without disturbing brood fish by sampling for eggs with a 0.5-inch glass tube. The tube is inserted vertically into the tank, and a water sample with eggs is collected from the water column by placing the thumb over the end of the tube to create a vacuum. Eggs can then be observed through the tube when it is removed from the water. Brood fish should be left in the spawning tank for at least 1 hour after spawning, because their movement in the tank helps to keep the eggs in suspension until they water harden.

After the fish have spawned and the eggs have water hardened, brood fish can be removed using large-mesh dip nets. Males can be held and reused if necessary, but this practice is not recommended if fresh males are available. Post-spawn brood fish can be returned to the wild or placed in holding ponds.

Maintenance of Eggs and Fry

Maintenance of striped bass eggs and fry is much easier in tank culture than in jar culture. Eggs and fry should be left in spawning tanks during development because transfer will result in some mortality. If spawning tanks are limited, fry can be siphoned out of tanks when they are 2 days old and moved to other holding facilities. Enumeration of eggs and fry can be

done by taking volumetric samples with a 0.5-inch diameter glass or plastic tube. The tube is inserted and removed the same way as described for sampling for spawning in tanks with murky water. Once the tube is removed, the volume of water in the sample is measured, and the eggs or fry are counted. At least 5 or 6 samples should be taken due to the possibility of non-uniform distribution of eggs and fry within the tank. At water temperatures of 68°F, an egg sample can be taken 4-6 hours after spawning to check for proper egg development and to determine numbers and fertilization rates. Sampling can be delayed several hours after spawning at colder temperatures to allow proper cell division to occur before obtaining fertilization estimates. Another group of samples should be taken after all of the eggs have hatched, usually 36-48 hours after spawning at 68°F, to estimate hatching success. A final sample might be taken at 3 days post-hatch to determine approximate numbers of fry that will be available for stocking or shipment 4 to 5 days post-hatch. Samples taken after day 3 may result in inaccurate estimates because of non-random distribution. Each sample of eggs and fry represents the number in a known volume of water: the volume inside the glass tube. Counts are averaged to determine the number of fry per sample volume. The number per unit volume is determined and multiplied by the total volume of the spawning tank to estimate the total number of fry.

Chemical treatment of eggs and fry is sometimes necessary to control or prevent fungal infections. Suggested treatments and dosages are discussed in Chapter 13.

Removal of Fry

Harvesting fry for stocking or shipment will be necessary when fry are 4 or 5 days old at water temperatures of 68°F. Tank construction should be such that it can be dewatered to concentrate fry without escapement. Fry can be removed from spawning tanks by dipping or siphoning. A 1-gallon plastic milk jug with the bottom cut out makes an excellent scoop for dipping the fry out of the tank.

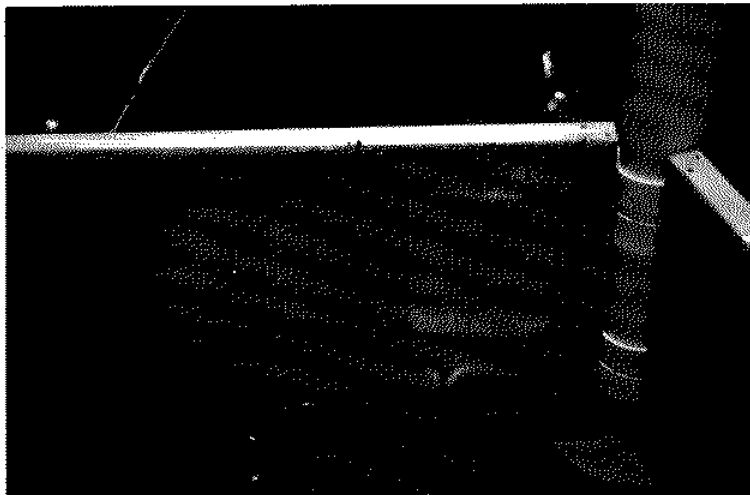

Siphoning through a 0.25-inch diameter (or larger) flexible plastic hose directly into shipping boxes can be done without damaging fry if head differential and velocities are low. Crowding screens can be used to concentrate fry for easier removal (Figure 6.3). Methods for packaging fry are discussed in Chapter 5.

Figure 6.3. Crowding screen used for crowding larvae in circular tank culture of striped bass. Photo Credit: Tennessee Wildlife Resources Agency.

Pond Fertilization and Zooplankton Management Techniques for Production of Fingerling Striped Bass and Hybrid Striped Bass

James G. Geiger and Charles J. Turner

The major differences between pond culture as described by Bonn et al. (1976) and pond culture as envisioned today (Geiger 1983a,b; Turner 1984) for production of striped bass (*Morone saxatilis*) and hybrid striped bass revolve around the concepts of modern zooplankton management: (a) aggressive pond fertilization with combinations of organic and liquid inorganic fertilizers; (b) inoculation or "seeding" of rearing ponds with preferred crustacean zooplankton; and (c) monitoring zooplankton populations and their food sources, as well as basic water quality characteristics. These strategies have two objectives: (1) to maximize numbers of preferred crustacean zooplankton before stocking ponds with larval fish; and (2) to maintain populations of these crustaceans for as long as possible thereafter. Our objectives in this chapter are to explain the basic principles of freshwater zooplankton management, and to describe pond fertilization and zooplankton management strategies that have proven successful for the production of striped bass fingerlings.

Zooplankton Communities

Zooplankton management involves the manipulation of zooplankton communities. In striped bass culture ponds, zooplankton communities are dynamic and respond to a wide variety of environmental conditions, including light, availability of nutrients, and water quality characteristics. To manipulate these communities, the culturist must have a basic understanding of the pertinent life history characteristics of zooplankton.

Fortunately, freshwater zooplankton community structure can be greatly simplified for the purposes of striped bass culture. The vast majority of zooplankters in a typical culture pond belong to only two groups, rotifers and crustaceans. The crustaceans are further subdivided into cladocerans, copepods and their nauplii, and ostracods. Therefore, the culturist may think

of the entire zooplankton community in terms of only four groups: rotifers, cladocerans, copepods, and ostracods.

Zooplankton Life Histories

Life history data can also be simplified. Zooplankton life history characteristics tend to be similar within individual groups, but somewhat dissimilar between groups. For example, life histories of the cladocerans *Daphnia* and *Scapholeberis* are more similar to each other than to the life history of any rotifer. To manage zooplankton for striped bass culture, the culturist need only be familiar with summarized life history characteristics of each of the four major groups.

The most important life history characteristics are birth rates (measured as egg-to-egg time, peak reproductive age, and brood size), growth rates (a function of feeding efficiency), and mortality rates (life span and, more important, vertebrate predation). Tables 7.1 and 7.2 provide a summary of life history characteristics.

Rotifers. Rotifers are frequently the most abundant zooplankters in culture ponds. Common genera are *Brachionus*, *Keratella*, and *Polyarthra*. They are small (60-800 μm) zooplankters characterized as having a ciliated corona (disk-like "revolving wheels"), which serves for both locomotion and as a mechanism for bringing food particles into their mouthparts.

Reproduction is primarily asexual (parthenogenetic). Once or twice each year, thick-walled resting eggs are produced by sexual reproduction that are resistant to adverse environmental conditions, especially desiccation. They hatch when ponds are refilled and environmental conditions are favorable. Reproductive rates are strongly correlated with quantity and quality of available food. Due to their feeding mechanism, rotifer diets are generally restricted to small particles, including small algal cells, diatoms, periphyton, and organic detrital particles with their associated bacterial and protozoan communities.

Rotifers mature rapidly, depending on water temperature (Table 7.1), and reach a maximum reproductive peak earlier than other pond zooplankton species. As a result, rotifers are effective colonizers and can establish large population densities very quickly in culture ponds. However, their short life spans (5-20 days) and generally small brood sizes (2-4 eggs per brood) are reproductive constraints. Nutritional deficiencies can also limit reproduction. Useful references on rotifers include Edmondson (1959), Hutchinson (1967), Ruttner-Kolisko (1974), and Pennak (1978).

Cladocerans. Cladocerans ("water fleas") are small to medium-sized (300 to 3000 μm) zooplankters that have a transparent bivalve carapace that encloses the entire body except the head and antennae. A large, compound eye is the most conspicuous feature of the head. Movement is generally by a "hop-sink" type of locomotion.

Table 7.1 Life history characteristics of the important freshwater zooplankton taxa (modified from Allan 1976).

	Temperature (°C)	Egg-to-Egg (days)	Total Young per Adult Lifespan	Lifespan (days)	Time of Peak Reproduction (days)
Rotifera	10	5-7	15-25	20	8.0
	20	2-3	15-25	12	3.5
	25	1.2-1.7	15-25	5	2.0
Cladocera	10	20-24	400-600	85	26.0
	20	7-8	400-600	50	14.5
	25	5.5-6.5	500-700	40	13.5
Copepoida ¹	10	28-32	250-500	85	40.0
	20	13-15	250-500	50	24.0
	25	7-8	500-750	40	17.5

¹ Data are primarily applicable to calanoid copepods. Cyclopoid copepods will generally have shorter life history stages.

Table 7.2. Ecological characteristics of the important freshwater pond zooplankton taxa (modified from Allan 1976).

	Rotifera	Cladocera	Copepoda ¹
(1) Body Size (mm)	0.2-0.6	0.3-3.0	0.5-5.0
(2) Food Size (µm)	1-20	1-50	2-200
(3) Feeding mechanism	Suspension feeding via coronal cilia	Filter feeding via thoracic appendages	Filter feeding and/or biting seizing mouthparts
(4) Filtering rate	very low	high	low
(5) Vertebrate predation (fish)	very low	high	low

¹ Data are primarily applicable to calanoid copepods. In saltwater ponds, zooplankton communities may consist of rotifers (*Brachionus* spp.) and calanoid copepods (*Acartia* spp.), although harpacticoid and cyclopoid copepods may also be present. See McCarty et al. (1986) for further information.

Cladocerans are primarily filter feeders and ingest a wide variety of food items, including small unicellular algae, diatoms, protozoa, bacteria, and organic detritus. They have the ability to actively select different types or sizes of food, and may adjust their filtration mechanisms to concentrate on locally abundant food items. These organisms are even capable of filtering bacteria directly from the water. Due to these characteristics, their feeding efficiency is much higher than that of most other zooplankters.

Reproduction of cladocerans is primarily asexual (parthenogenetic). However, males may be produced when environmental conditions become adverse; sexual reproduction results in two resting eggs contained in a dark-colored, saddle-shaped structure called an ephippium. Ephippial eggs are resistant to dry conditions and survive until environmental conditions are favorable (e.g., when a pond is refilled). Ephippial eggs hatch into females, and asexual reproduction continues.

Cladoceran generation times are longer, and time of peak reproduction is later than that for rotifers (Table 7.1). Cladoceran brood sizes, however, are much larger than those of rotifers. Because of these reproductive characteristics, cladocerans are typically found in small numbers for 1 to 2 weeks after a culture pond is filled (while the first and second generations mature), but the populations explode shortly thereafter when the first generations reach the age of peak reproduction.

Cladocerans and rotifers generally compete for the smaller food particles. Because of their high feeding efficiency and large broods, cladocerans have a competitive advantage over rotifers and usually become predominant when they compete directly. Rotifer populations normally remain depressed as long as cladoceran (and copepod) populations are abundant.

As prey, cladocerans are an excellent choice because they have high energetic food value, are preferred food items for many larval fish species (including striped bass), and most are slow swimmers with poor evasive abilities. Consequently, cladoceran populations usually decline rapidly when subjected to predation, whether by striped bass or other fish species (Hurlbert et al. 1972; Geiger 1983a; Geiger et al. 1985), or by invertebrates (Wright 1965). Adverse environmental conditions, as well as decreased food quantity and quality, can cause severe population declines (i.e., crash). For additional information see Brooks (1959), Hutchinson (1967), Pennak (1978), and Hebert (1978).

Copepods. Copepods can be divided into three main suborders: the Cyclopoida, the Calanoida, and the Harpacticoida. Cyclopoids and calanoids are the dominant copepods in striped bass culture ponds; harpacticoids seldom appear in either zooplankton samples or in striped bass stomach samples. As a group, copepods are medium to large zooplankters (500 to 5000 μm in greatest dimension).

The cyclopoids are characterized by mouth parts that are adapted for biting and seizing food items. They feed on a wide variety of food items, including unicellular algae, organic detritus, and other invertebrates. Calanoids are generally filter feeders, and seem to show some

of the feeding selectivity shown by cladocerans regarding size and type of food particle ingested.

Copepod life histories are difficult to summarize because of their wide variety of habits. In general, copepods are more efficient feeders than rotifers and, when food is abundant, they are less efficient than cladocerans. However, when food is scarce (i.e., when ponds "clear up"), copepods are better able than cladocerans to adapt to secondary food sources. Their ability to use alternate food sources and their evasiveness help them maintain their numbers under adverse conditions.

Copepods are swift, powerful swimmers, and their speed allows them to withstand vertebrate predation far better than cladocerans. Accordingly, copepod populations are better able to maintain their densities in ponds during the latter portion of the culture period, when fish predation is most intense.

Copepods are bisexual. Larvae proceed through five or six naupliar stages, usually followed by six copepodid stages, before reaching maturity. Under adverse environmental conditions, resting eggs are produced (calanoids and cyclopoids) which can undergo a period of diapause. Resting eggs hatch when environmental conditions are more favorable.

Depending on environmental conditions, copepod brood sizes usually range from 10-40 eggs per clutch. Typically, egg-to-egg generation times are slightly slower than for cladocerans, but life spans are similar (Table 7.1). Life spans are longer, broods are larger, and egg-to-egg times are relatively longer in cladocera and copepoda than in rotifers (Table 7.1). Further information is provided by Wilson and Yeatman (1959), Hutchinson (1967), and Pennak (1978).

Ostracods. Ostracods ("seed shrimp") are crustaceans whose bodies are completely enclosed in a sclerotized bivalve. Ostracods are relatively large zooplankters (frequently 1 mm long) and are easily visible to the naked eye. They are usually scarce during the early pond culture period, but may become very abundant, even the predominant crustacean, during the pond culture period.

Ostracods are not a preferred prey, but are occasionally eaten by striped bass. The ostracod's shell resists digestion, and the animals usually pass through fish digestive tracts intact. Because they are apparently indigestible, their nutritional value to fish is questionable.

During the latter pond culture period, preferred zooplankton species (copepods and cladocerans) are usually scarce. However, culturists may sometimes assume that zooplankton stocks are adequate because an ostracod "bloom" is so prominent. Culturists should recognize ostracods on sight and not confuse them with more desirable and beneficial forms of zooplankton. Ostracods are easily recognized by their generally dark color and characteristic swimming motion. They appear to "wobble" or "spiral" through the water, whereas copepods appear to dart, and cladocerans "hop-sink."

Development of Zooplankton Communities

Ponds seldom contain a random mixture of equally numerous zooplankton species. Instead, biological and environmental conditions usually favor one group or a few species that become very abundant. These species remain dominant until environmental conditions change, and if the new conditions do not favor the dominant species, they begin to decline and are soon succeeded by different species. This natural pattern of succession, from one dominant zooplankton group to the next, continues as long as environmental conditions continue to change. We here define a zooplankton succession pattern as the development and domination of one zooplankton group at the expense of other groups due to changing biological and environmental factors impacting the entire pond community.

The characteristic zooplankton successional pattern in striped bass ponds is largely due to the interaction between biological factors (primarily the life history characteristics previously discussed) and environmental factors (primarily water temperature and light intensity and duration). Hurlbert et al. (1972) described an excellent example of community succession under similar circumstances, and Wetzel (1975, chapter 16) provided an excellent discussion of zooplankton, benthos, and fish community interactions.

The zooplankton succession pattern characteristic of striped bass culture ponds generally involves three distinct successional communities: (1) the initial rotifer community; (2) the crustacean community; and (3) the climax community.

Initial rotifer community. The initial community that generally occurs 7 to 14 days after ponds are filled is a colonizing one. Rotifers predominate largely because they quickly mature and begin to reproduce. Copepods and cladocerans (which mature more slowly) are scarce as adults, although copepod nauplii and early instar cladocerans may be present. Invertebrates that cannot produce resting eggs (e.g., midges) are also scarce. Phytoplankton density is variable.

Crustacean community. Development of this community is triggered by the maturation of first- and second-generation crustaceans (14-28 days after filling ponds). As this community is developing, early and intermediate instar cladocerans and copepod nauplii are abundant. When the community matures, adult crustaceans predominate and immature forms vary in number. Rotifers compete poorly with crustaceans so their population densities decline. Rotifers may be virtually absent in a pond containing a mature crustacean community.

Other significant changes also occur in the rearing pond environment during this period. Fairy and clam shrimp (of the orders Anostraca and Conchostraca, respectively), if present, rapidly increase in number and size. Phytoplankton usually decline due to grazing by cladocerans and by fairy and clam shrimps. Other invertebrates, such as ostracods and midge larvae, appear in variable numbers. This community is most advantageous for striped bass culture. Larval fish are normally stocked 7-14 days after the pond is filled, when small crustaceans are abundant and the populations are expanding.

Climax community. The last community develops between 28 and 45 days after the pond is filled, primarily in response to intensive predation by striped bass fingerlings. Environmental factors, such as high temperatures and low food supplies, may limit crustacean reproduction and thus help begin the shift from the crustacean to the climax community. Once in place, the climax community usually persists until ponds are harvested.

The most immediate effect of intensive fish predation is the elimination of large cladoceran species such as *Daphnia*. Copepod populations may persist, but are usually suppressed. Basically, "non-preferred" zooplankton (i.e., rotifers and ostracods) dominate this community, but small, non-preferred crustaceans (e.g., *Bosmina*), may also be common.

Striped bass growth rates generally decline as fish shift to alternative food supplies. This is also the time when cannibalism may increase in striped bass as a result of the decreased zooplankton. Phytoplankton may increase in response to elimination of large, filter-feeding cladocerans.

Zooplankton Management

Our original objectives can now be redefined with respect to the three zooplankton communities just described: (1) minimize the duration and impact of the initial rotifer community; (2) promote rapid development of the crustacean community in order to provide numerous early instar crustaceans when the pond is stocked with fish; (3) maintain the largest possible crustacean biomass during the second successional phase of the pond culture period (10 to 20 days post-stocking); and (4) delay the onset of the climax community as long as possible.

Culturists should understand that they cannot prevent succession to the climax community, nor can they maintain abundant crustacean zooplankton populations throughout the culture period. As the fish grow, they require more food. Eventually, predation rates exceed crustacean growth and reproduction rates, and crustacean populations rapidly decline (or are eliminated). Depletion of these populations is inevitable, and cannot be avoided when fish are abundant. Objectives 2, 3 and 4 are therefore stated in accordance with a fundamental principle of zooplankton management: growing fish eventually and inevitably consume all of the desirable zooplankton.

Fish culturists have two principal tools for zooplankton management — aggressive pond fertilization and selective inoculation. The purpose of aggressive pond fertilization is to maximize zooplankton food sources, particularly during the early portion of the culture period when crustacean populations are reproducing and expanding. The purpose of selective inoculation is to provide an initial (or supplemental) stock of mature crustacean zooplankton when the pond is filled.

Aggressive fertilization strategies and selective inoculation accelerates crustacean zooplankton growth and reproductive rates, thus shortening the duration of the initial rotifer community by competition, and providing an abundant supply of early instar crustaceans. Ear-

ly instar crustacean populations are important, because they provide an abundant food supply for newly stocked striped bass fry, and they mature and reproduce. The progeny provides abundant food during the following 15- to 20-day period; therefore, all specified objectives can be attained.

Pond Fertilization

Pond fertilization has recently been reviewed for sport fish production (Boyd 1982), intensive pond production of warmwater anadromous fish (Geiger 1983b; Turner 1984), and for production of saltwater fish species (McCarty et al. 1986; Harrell and Bukowski 1990). The biological objective of fertilizing rearing ponds is to stimulate the development of all zooplankton foods, including aquatic bacteria, desirable green unicellular algae, protozoa, and organic particulate matter colonized by combinations of these organisms. We recommend that combinations of organic and liquid inorganic fertilizers be used to meet this objective.

Organic fertilizers. Organic fertilizers include a wide array of animal manures, various hays, plant meals (alfalfa, soybean, cottonseed, sunflower), rice brans, sugar refinery wastes (bagasse), wheat shorts and yeast (from brewery wastes or by-products), and meat scraps. As these organic fertilizers decompose, they release inorganic nutrients that stimulate phytoplankton growth, and organic nutrients that serve as direct food sources for heterotrophic communities such as aquatic bacteria, protozoa, and various invertebrate species, as well as for the fish being cultured.

Disadvantages of using large amounts of organic fertilizers stem from their decomposition rates. Large quantities of rapidly decomposing organic fertilizer sometimes cause rapid dissolved oxygen depletion. Additionally, large quantities of slowly decomposing organic fertilizer may stimulate large standing crops of vascular aquatic vegetation or filamentous algae. To mitigate the water quality and aquatic weed problems, we suggest the following criteria for choosing organic fertilizers:

- (a) They should have low carbon:nitrogen ratios to permit rapid decomposition. The culturist has only a limited time to manipulate food webs in ponds and does not need organic fertilizers with high carbon:nitrogen ratios that are not biologically active.
- (b) Particle size should be as fine as possible to allow faster colonization by bacteria, protozoans, fungi, and algae, which results in more rapid decomposition and solubilization of key nutrients.
- (c) Organic fertilizers should be applied as frequently as manpower constraints allow (i.e., at least daily). Increased frequency of application reduces variation typically shown in zooplankton pond populations.
- (d) The fertilizer should be readily available and economical.

Inorganic fertilizers. This group of fertilizers may be in the form of powders, flakes, pellets, granules, or liquids. We recommend the use of liquid inorganic fertilizers, because they are generally easier to apply and more economical than granular fertilizers (Boyd 1984; Reeves and Harders 1985). Numerous states have incorporated the use of liquid inorganic fertilizers into their pond production regimes with excellent results. Liquid fertilizers can be custom formulated to specifications (liquid polyphosphate fertilizer). Stock solutions of phosphoric acid and ammonium nitrate can be applied directly to production ponds to obtain the desired levels of phosphorous and nitrogen. Because liquid inorganic fertilizers are more soluble than granular fertilizers, the rate of uptake of key primary nutrients (such as phosphorous and nitrogen) by phytoplankton is faster. Thus, liquid inorganic fertilizers allow management control and flexibility in manipulation of primary and secondary productivity in rearing pond systems. Application at low rates, but higher frequencies, can reduce much of the limnological and biological variation that adversely affects the extensive pond production of freshwater and saltwater finfish species; however, misuse occurs. An excellent rule of thumb is to apply liquid inorganic fertilizer only when phytoplankton levels are stable or increasing. If pond waters clear (Secchi disk readings ≥ 25 inches), liquids should be applied at once at a rate of 1-2 ppm active ingredient (P_2O_5), based on total pond volume. If this application does not stimulate phytoplankton production, its use should be discontinued. In these situations, it is possible that the wrong formulation is being used, that phytoplankton levels are being limited by zooplankton grazing pressure, or that environmental conditions are adverse (e.g., excessive water flow or leakage from ponds, low alkalinity, high alkalinity water with high pH, and temperatures that are too low or too high). We caution against further fertilization, even with different formulations because it can exacerbate the growth of rooted aquatic vegetation, blue-green algae, or filamentous algae in ponds.

In summary, liquid inorganic fertilizers should meet four requirements:

- (a) They should contain nitrogen to enhance bacterial generation, thus allowing faster decomposition of organic fertilizers. The addition of nitrogen also helps prevent a dominance shift to blue-green algae, which fixes nitrogen. It should be noted that saltwater ponds can be nitrogen limited.
- (b) They should contain adequate amounts of phosphorus in a soluble form to allow rapid uptake by desirable unicellular green algae and minimize absorption into sediments or chelation into unusable inorganic complexes. Normally, phosphorous is the limiting nutrient in freshwater ponds.
- (c) They should be well mixed with water in a container (fertilizer should always be added to water — do not add water to fertilizer) and dispensed evenly over the pond surface by spraying, pumping, or broadcasting. Mixing ponds with aeration devices, such as air-lift pumps (see Chapter 12), maximize distribution of nitrogen and phosphorus throughout the water column.

(d) They should be economical and easy to apply. This characteristic allows management flexibility in selecting amounts and ratios of phosphorus and nitrogen to enhance primary and secondary productivity.

If separate sources are used for phosphorus and nitrogen (such as liquid phosphoric acid and liquid ammonium nitrate), these liquids should be applied separately to prevent possible precipitation of materials due to the high specific activities of phosphorus and nitrogen.

Culturists should distinguish between autotrophic productivity (phytoplankton stimulated by inorganic fertilizers) and heterotrophic productivity (bacteria and protozoans stimulated by organic fertilizers). Nutrient demands by autotrophic and heterotrophic pond communities are continual. Harvesting of these communities is also continual (Schroeder 1987). Therefore, continuous low-level pulses of organic and liquid inorganic fertilizers may best meet the nutrient demands of the entire rearing pond community.

Production of maximum biomass requires exploitation of virtually the entire food base in rearing ponds (Schroeder 1978). Full development of this food base requires supplemental applications of organic and inorganic nutrients, so both organic and inorganic fertilizers must be used to effect maximum yield.

Zooplankton Inoculation

Often the inoculation or "seeding" of rearing ponds with desirable adult zooplankters before striped bass larvae are stocked can shift the pond community away from the initial zooplankton populations observed 7 to 14 days post-filling (Geiger 1983a), and increase populations composed of larger, adult crustaceans. When provided with an optimum nutritional base by aggressive pond fertilization techniques, this community, dominated by adult crustaceans, can rapidly increase in numbers of organisms in a relatively short time. Thus, inoculation is particularly important if pond filling is limited to relatively sterile well water or spring water. Inoculation techniques allow the rotifer impact on the nutrient base to be reduced during the initial zooplankton community stage. By increasing the numbers of adult crustaceans, accelerated stimulation of natural pond successional patterns can be achieved. Succession can be accelerated in spite of unfavorable environmental conditions and may advance zooplankton pond dynamics by as much as 7 to 14 days.

The same advantage can be gained by using more fertile surface water sources. Ponds containing channel catfish, *Ictalurus punctatus*, fed with commercial feed serve as excellent sources of zooplankton. Special inoculation ponds can also be set up and fertilized intensively before the production season begins.

Zooplankton can easily be caught at night by placing lights over kettle areas of the pond to attract zooplankton and using submersible, flexible-impeller pumps to pump water through plankton nets of 150- to 183- μm mesh. The larger mesh will retain adult copepods and cladocerans while allowing the escape of smaller rotifers and early instar cladocerans and copepod nauplii. Concentrated zooplankton should be placed in aerated pond water, counted

(number of organisms per liter), and known quantities released into each production pond being filled, thus providing a known "seed stock" of adult organisms. Ponds can be re-inoculated as often as desired before fish are stocked, although early inoculations have a greater effect than later ones. Ponds should be monitored and estimates of absolute zooplankton numbers and composition determined before fish are stocked. This information may facilitate adjustments for better management in the future.

Monitoring Pond Zooplankton Populations

Culturists must know what is in their rearing ponds to manage them effectively and efficiently, so zooplankton populations should be monitored. Knowing typical zooplankton succession patterns under various production protocols ensures increased fish production and more effective use of manpower (Parmley and Geiger 1985). Knowledge of individual pond zooplankton dynamics and succession patterns allows culturists to perform several operations: (1) assess the effects of inoculation techniques; (2) "fine tune" pond fertilization protocols; (3) decide when and how many larval fish should be stocked for optimal survival; (4) determine when to begin supplemental feeding or schedule harvests from weekly evaluations of zooplankton densities; and (5) better coordinate spawning activities, with pond preparation, filling, and fertilization schedules.

Sampling. In general, zooplankton sampling gear can be divided into two categories: net samplers, which collect and concentrate the plankton; and volume samplers, which collect a known volume of water that is filtered through a net to concentrate the organisms (Bottrell et al. 1976).

In the first category, a net is pulled through the water in a technique that is known as the tow sample method. There are three types of tow samples: (1) Vertical tows are made by lowering a weighted net to a specific depth and then raising it at a constant speed. They are used in larger, deeper waters, and are generally unsuitable for shallow ponds. (2) Horizontal tows are taken by lowering the net to a pre-selected depth and towing it at this depth for a known distance. (3) Oblique tows are collected by lowering the net to a pre-selected depth then gradually increasing the towing speed so that the net gradually comes to the surface and samples the entire water column. Oblique and vertical tows nearly always collect a representative sample, but horizontal tows do not (APHA et al. 1975). An oblique tow is probably the best technique for small, shallow production ponds.

The volume of water sampled by any of these net samplers can be calculated by the formula $V = \pi r^2 d$, where π is the constant *pi* (3.14), r is the radius of the net opening in meters, d is the distance the net is towed in meters, and V is the volume of water (cubic meters) sampled (APHA et al. 1975).

Volume samplers are probably the most accurate sampling devices because they usually yield the highest estimates of zooplankton densities (Bottrell et al. 1976). They include Kemmerer and Van Dorn-type water samplers, the Juday plankton trap and its various modifications, and various motorized pumps. The Kemmerer and Van Dorn samplers and the Juday

plankton trap are relatively awkward and bulky to use, and samples are limited to 5 to 10 liters of water per set. These samplers are also time-consuming in operation.

A more recent sampling technique involves the use of different types of commercial pumps. Previously, these devices were used to sample large, deep bodies of water (O'Connell and Leong 1963; Leong 1967; Beers et al. 1967; Lenz 1972). All had relatively large pumping rates, and passage through the pumps frequently damaged various zooplankton species, making their later identification and quantification difficult. Small, flexible-impeller pumps, used to rapidly sample zooplankton populations in rearing ponds for striped bass and red drum (*Sciaenops ocellatus*) (Geiger 1983a; Turner 1984; McCarty et al. 1986), have reduced or eliminated many of the problems related to zooplankton sampling in shallow ponds. Clogging of nets by filamentous algae, aquatic macrophytes, and detritus is largely avoided, and the volume of water filtered is measured more quickly and accurately. Farquhar and Geiger (1984) developed a portable zooplankton sampling apparatus that enables one person to collect samples from hatchery production ponds at the rate of 6 per hour.

Avoidance by the larger copepods and cladocerans does not appear to be a problem when flexible-impeller pumps are used; however, the listed pumping rate should not be less than 30 L/minute, to minimize possible avoidance. The main disadvantage of these pumps is the initial cost of U.S. \$60-90 per pump, but with care and routine maintenance, they are durable and can be used for a variety of functions around the laboratory or hatchery.

More recently, Graves and Morrow (1988) developed a tube sampler for sampling zooplankton in ponds. Culturists must decide what zooplankton sampling gear best fits their particular facility. Regardless of the gear chosen, mounting evidence indicates that a combination of techniques may be needed to ensure a complete evaluation of particular plankton communities (Rey et al. 1987).

Zooplankton samples should be taken at more than one station in production ponds larger than 0.5 acre, to ensure an accurate assessment of the zooplankton community (Harrell and Bukowski 1990). Samples can be analyzed separately or pooled for later analysis. If personnel constraints prohibit sampling multiple stations per pond, a larger volume of water (15 to 30 liters) should be taken for the single sample. One zooplankton sample of 20 to 30 liters is usually adequate to accurately assess the zooplankton population and provide sufficient information to make informed management decisions.

Ponds should be sampled at least weekly, but semiweekly sampling allows a better assessment of population trends. It is important to know the trends before larval fish are stocked. Sampling should be maximized during the 2 weeks before and after the fish are stocked to better assess the status of crustacean stocks (Geiger 1983b; Turner 1984).

A chilled, buffered, 4-5% formalin solution is the recommended preservative for zooplankton (Haney and Hall 1973; Prepas 1978). The contents of 1 L of 4% solution are 2 g of sodium tetraborate (borax), 98 mL of "full strength" formalin solution (ca. 38% formaldehyde),

900 mL of distilled water; and 40 g of sucrose (table sugar). By including sucrose and chilling the preservative, swelling or "ballooning" of the carapace in cladocerans and copepods is largely prevented. Gravid organisms also retain their eggs. Adding 0.04% Rose Bengal stain (specific for chitin exoskeletons) helps to differentiate zooplankton from algal and detrital material (Weber 1973). Anesthetizing zooplankton with low doses of MS-222, chloral hydrate, or CO₂ (club soda, baking soda) before preservation will prevent the abortion of eggs by gravid cladocerans. Anesthetics should be added in small quantities at a time until zooplankters lose their equilibrium.

Quantitative analysis of zooplankton is most easily performed with a quality stereoscopic microscope equipped with an ocular Whipple grid and a Sedgwick-Rafter counting cell. For larger copepods, cladocerans, and rotifers, count the organisms in the entire cell. For smaller rotifers and copepod nauplii, the strip method may be used (Weber 1973; APHA et al. 1975). Results are expressed as number of rotifers, cladocerans, and copepod nauplii per liter. At least two (preferably three) 1-mL Sedgwick-Rafter cells should be counted per sample and the results averaged. Total zooplankton counts per cell should be at least 200.

Calculations for Sedgwick-Rafter cell

$$\text{Organisms/L} = \frac{\text{Number of Organisms Counted} \times 1000}{\text{Concentration factor (CF)}}, \text{ where}$$

$$\text{CF} = \frac{\text{Volume of water filtered (mL)}}{\text{Volume of concentrated sample (mL)}}$$

If possible, the size of cladocerans should also be measured (from the top of the head to the base of the post-abdominal spine). The larger the cladoceran, the more young will be produced, if levels of nutrition are adequate. Look for egg sacs (generally a single egg sac in calanoid copepods, and paired egg sacs in cyclopoid copepods) in mature copepods. Large numbers of gravid zooplankton usually indicate an expanding zooplankton population.

Additional biomass procedures and biochemical analyses can be performed to obtain precise estimates of zooplankton biomass. Although this may not be feasible due to time, money, and manpower limitations, such data do provide the most accurate assessment of secondary production in ponds (Jacobs and Grant 1978). Accumulation and analysis of zooplankton data allow meaningful comparisons of inoculation techniques, pond fertilization protocols, stocking rates, and supplemental feeding decisions (Fitzmayer et al. 1986).

In summary, we offer three recommendations: (1) Routinely monitor zooplankton populations in striped bass and hybrid striped bass production ponds; (2) take at least two water

samples per pond per week; and (3) monitor zooplankton with special care at the times immediately before and after stocking (it is critically important for the culturist to know what zooplankton are available in the pond to support and justify particular stocking rates).

Summary of Zooplankton Population Manipulation and Evaluations

It has been established that the production of fingerling striped bass and hybrids is greatly improved when larval fish are provided adequate numbers of high-quality zooplankton species during the culture period. Generally, newly stocked 5- to 7-day-old striped bass larvae are poor swimmers, are inefficient in capturing prey, and require much energy for survival and development. In addition, the high predatory pressure exerted by striped bass larvae on zooplankton populations makes it difficult to maintain adequate quantities of food for more than 2 or 3 weeks after fish are stocked into rearing ponds. Translated into management terms, for maximum production, culturists must do four things:

- (1) Establish large populations of high-quality zooplankters before stocking larval fish.
- (2) Maintain fertilization levels for as long as water quality characteristics permit.
- (3) Be aware that it is difficult, if not impossible, to generate large populations of high-quality zooplankters when large populations of fry and fingerlings are established (2 to 3 weeks post-stocking).
- (4) Monitor zooplankton populations as often as time and labor permit, especially during the crucial periods (immediately before and after stocking).

As a supplement to the preceding discussions, the following section highlights protocols that will enable an aggressive program to maximize zooplankton in rearing ponds. These highlights are intended to be a "guide," built on information in this and other chapters of this manual. By adhering to these guidelines, the culturist should greatly improve his production capabilities.

Pre-Stocking Pond Preparation

A certain amount of pond preparation is required before efforts are made to establish desirable zooplankton populations:

- (1) Earthen ponds should be dried, disked, bladed, and packed.
- (2) If there is a history of aquatic weed problems, pond bottoms should be sprayed or treated with an approved herbicide before filling begins.
- (3) Lime requirements should be determined and, if necessary, the proper amount of lime should be spread evenly over pond bottoms.

- (4) Ponds lined with plastic (high density polyethylene, hypalon, etc.) should be inspected for tears or punctures and repaired before they are filled.
- (5) Harvest kettles should be cleaned and all valves, screens, dam boards, supplemental power, and aeration systems checked for proper function.
- (6) Electrical and aeration systems should be checked for proper functioning and safety.

Pond filling. If the water for the ponds comes from cool groundwater and is essentially sterile, the ponds should be filled about 10 to 14 days before anticipated stocking with larvae. If the source is a reservoir or stream that is warmer than well water and has an abundance of zooplankton, it may be necessary to fill it only 3 to 7 days before stocking. Timing of pond filling and fertilization should reflect current water temperatures, availability of striped bass larvae, and the number of crustacean zooplankton "seed stock" present in primary water source.

Chemical treatment. The previous history of a particular pond may dictate that preventative chemical treatments may be necessary to reduce problems with predatory insects or aquatic vegetation. Be aware that most chemical treatments for insect larvae, fairy shrimp, and clam shrimp, as well as some chemical treatments for aquatic vegetation and filamentous algae, will severely affect developing crustacean zooplankton populations. Any *necessary* application should be made no later than 1 week pre-stocking and no earlier than 2 weeks post-stocking to ensure only minimal adverse effects on the rearing of pond zooplankton communities *and* their food sources.

Inorganic fertilizers. Inorganic fertilizer grades refer to percentages by weight of nitrogen (as N), phosphorus (as P_2O_5), and potassium (as K_2O). Both granular and liquid fertilizers are available; however, for flexibility in use and management, liquid fertilizers offer several advantages, including more rapid solubilization of key nutrients and faster response of the targeted biological community.

Several types of liquid inorganic fertilizers that are commercially available can be used. *Ammonium nitrate* (32-0-0 NPK) is usually a 32% nitrogen solution that can be applied at rates of 0.25-1.0 ppm active ingredient, based on total pond volume. *Never* apply the material near areas where fish are congregated. Nitrogen application levels can be increased, especially in brackish water or estuarine areas where N is a limiting nutrient. *Phosphoric acid* (0-54-0) is usually a 75% solution of phosphoric acid containing 54% P_2O_5 . Several grades are available (e.g., "green" or "black"). This material is generally diluted with water (at least 1:10, acid to water) before application. *Always pour acid into water* when diluting it (never pour water into acid). Phosphorous can be applied at rates of 0.25-1.0 ppm active ingredient, based on total pond volume. Application rates can be increased in fresh water where P is a limiting nutrient.

Nitrogen and phosphorous can be purchased in mixed formulations, such as liquid polyphosphate. These commercially formulated blends are usually 10-34-0 or 10-38-0 NPK. In

fresh water, the emphasis should be on supplying adequate phosphorus, especially when formulated polyphosphate blends are used.

Fertilizer calculations for liquid inorganics. Proper application of fertilizers can be calculated by using the following formula:

$$R = \frac{(V)(C)(K)}{(A)(D)}, \text{ where}$$

R = application rate in pounds,

V = pond volume in acre feet,

C = desired concentration of active ingredient in ppm,

K = a constant, 2.71 pounds per ppm per acre foot,

A = the proportion of active ingredient in the liquid fertilizer as a decimal fraction, and

D = density of liquid/gallon.

Rules of thumb. There are several rules of thumb that assist the culturist in making proper management decisions about fertilization. Ponds with Secchi disk visibility less than 20 inches should not receive inorganic fertilizers. Ideally, chlorophyll *a* levels should be maintained between 10 and 40 $\mu\text{g/L}$ (UV-VIS spectrophotometer). Liquid inorganic fertilizers should be applied only when phytoplankton populations are at stable levels or increasing. If ponds "clear up," apply the liquid fertilizer once at a rate of 0.5 to 1 ppm. If phytoplankton levels do not increase within 2-3 days after this "booster" application, do not apply more fertilizers. In such cases, phytoplankton levels are probably being limited by zooplankton grazing or adverse environmental characteristics such as temperature or light, and not by nutrient limitations.

Following these recommendations should reduce unnecessary fertilization and reduce development of unwanted aquatic vegetation and filamentous algae.

Organic fertilizers. Organic fertilizers should have low ratios of carbon to nitrogen to permit rapid decomposition and release of nutrients. The smaller the particle size of the organic fertilizer, the more effective it will be regarding nutrient release and providing relative surface area for bacterial and protozoan colonization.

Most southeastern states currently use cottonseed meal (40% protein) as their source of organic fertilizer. The type of organic fertilizer used typically depends on price, availability, and the quantity needed.

Initial application rates generally range from 200 to 500 pounds/acre at the time of pond filling, with later applications of 50 to 150 pounds/acre being made 5 to 7 days after the initial treatment. The frequency of supplemental applications will depend on available manpower.

Thus, the total organic load per rearing cycle in a pond may be as high as 1,200 pounds/acre. The total amount of loading obviously depends on water quality and project objectives.

A strategy that increases supplemental fertilization (two or more times weekly) results in the reduction of weekly variability in zooplankton populations. The duration of follow-up applications can range from 2 to 4 weeks, depending on water quality and the size of fingerlings desired. Fertilizer applications should always be evenly distributed over the pond.

Dissolved oxygen (DO) concentrations should always be closely monitored, and application rates of organic fertilizers adjusted as DO decreases below 4 ppm.

Zooplankton inoculation. If water sources are deficient in crustacean zooplankton (e.g., well water), ponds should be inoculated with desirable zooplankton at the time of filling. Sufficient quantities of desirable zooplankton can be concentrated by pumping fertile water from a rich zooplankton source through a 150 μm net to capture adult cladocerans and copepods. Once zooplankton is collected, place it in a 55-gallon plastic trash can or other appropriate container filled with aerated water. At this time, subsample the population and determine the numbers of crustaceans per liter, and evenly distribute equal aliquots to each production pond during filling. At a minimum, pond zooplankton densities (adult copepods and cladocerans) should equal at least 100/liter before fish are stocked. A goal of 500 crustacean zooplankters per liter before stocking (including early instar *Daphnia* and copepod nauplii) is not unrealistic.

Fry Stocking Guidelines and Rates

As a guide, before stocking striped bass or hybrid striped bass into ponds the following criteria should be met:

- (1) The pond water should have Secchi disk readings of 20-35 inches (chlorophyll *a* levels between 10 and 40 $\mu\text{g/L}$), and the minimum number of adult crustacean zooplankters should be 100/liter.
- (2) The average pond temperature should exceed 64°F, but should not exceed 80°F.
- (3) Dissolved oxygen readings should not be less than 4 ppm just before sunrise.
- (4) Ideally, fry should be stocked just before sunrise or after sunset; they should not be stocked in direct sunlight.
- (5) Stocking rates should be adjusted to meet program needs, regrading size, and number of fingerlings desired. With proper fertilization and zooplankton management, stocking rates of 200,000-300,000/acre, with fish yields of 75-100 pounds/acre are not unreasonable.
- (6) Larvae should be accurately estimated volumetrically or counted with an electronic fish counter. A tube of known volume (10 mL) can be inserted into an aquarium or bag and a sample withdrawn. Larvae can then be killed (formalin or MS-222) and counted. Ten

samples are taken from each container and counted. Discard the high and low samples, and use the other eight to calculate the number of larvae per milliliter in the container.

(7) Apply supplemental water or aeration to the pond as soon as possible if dissolved oxygen drops below 3 ppm.

Zooplankton Sampling

Because of the importance of zooplankton in relation to striped bass survival and growth, it is critical that zooplankton populations be monitored as often as possible. Samples may be taken with tow nets, pumps, or tube samplers, but a known volume of water should be sampled. Accuracy of the samples improves as volumes and numbers of sampling sites per pond increase.

Recommended timing of sampling is shown on the activity chart presented later. Samples should be taken and analyzed immediately before the ponds are stocked to determine numbers and types of zooplankton present.

Always preserve zooplankton samples in a cold, buffered formalin-sucrose solution containing 2 g of borax in 98 mL of full-strength formalin, 900 mL of distilled water, and 40 g of sugar. Refrigerate and use cold.

Zooplankton enumeration should be as follows: identify cladocerans to genus (*Daphnia*, *Bosmina*, etc.); copepods as nauplii or adults, and appropriate suborders (e.g., Cyclopoida, Calanoida, Harpacticoida); and count or note rotifers, ostracods, fairy shrimp, and midge larvae. Preferably, three replicate samples should be taken per station and counted, and an average number of organisms per milliliter calculated. After the average concentration is known, total organisms per liter can be estimated for each classification per pond.

Fish Sampling

We recommend that fish be sampled at least 24 to 48 hours after stocking, 7 days after stocking, and at weekly intervals thereafter. Live lengths (total length) and weights (g) should be taken after collection, and the samples preserved for later gut analysis. After sample fish are measured or weighed, their heads may be pinched to kill them, to prevent them from regurgitating the gut contents when they are placed in preservative. Collected fish can be preserved in the same preservative solution used for the zooplankton sample, then frozen. Stomach analysis and subsequent calculation of feeding preferences can be valuable in refining pond fertilization protocols.

Supplemental Feeding of Ponds

It may be desirable to provide supplemental feed to the fish while they are still in the ponds, especially when program objectives call for larger fish (i.e., phase II; 3-10 inches TL). If implemented, supplemental feeding should begin by the time the fish have been in rearing ponds 21 days, or when zooplankton populations begin decreasing.

Initial daily feeding rates of at least 5 pounds of feed per acre per day is desirable. Multiple feedings per day will more rapidly convert striped bass to artificial feed. In terms of particle size, fry starter is usually used the first week, followed by number 1 granules.

Pond Harvest

As harvest time approaches, careful attention should be given to fish and zooplankton samples. If the fish stop growing or zooplankton stocks become depleted, immediate harvest should be considered. Normally, the duration of phase I striped bass culture varies from 28-60 days, depending on specific program objectives and environmental characteristics such as temperature, water quality, and zooplankton abundance.

Striped bass fingerlings are extremely sensitive to stress and shock during harvest procedures; this sensitivity is apparently increased by the elevated water temperatures that normally accompany pond harvest operations. During harvest, fish should be handled as little as possible, direct sunlight should be avoided, and water temperatures should be kept as cool as possible.

Aeration should be supplied in harvest and transportation tanks; tanks should contain low levels of salinity (5-10 ppt) and approved bacteriostats at recommended levels. Low levels of anesthetic can also be used to tranquilize fish and reduce stress.

Ponds should be drained during the night or early in the morning to avoid increasing water temperature and direct sunlight. Glass V-traps (Bonn et al. 1976) have been used when aquatic vegetation presents a harvest problem, or approved herbicides can be used before the fish are harvested, to allow the fish access to the drain structure during harvest.

Accurately inventory the number of fingerlings harvested by taking a sample of fish, weighing them, and determining the average weight or number of fish per pound. Fish can then be placed in pre-weighed volumes of water and weighed to determine total numbers and weight harvested.

Summary

Successful phase I striped bass pond fertilization and zooplankton management requires four steps:

- (1) Application of a combination of liquid inorganic and organic fertilizers.
- (2) Inoculation with zooplankton, especially when primary water sources lack adequate numbers of crustacean zooplankton.
- (3) Having adequate numbers of desirable crustacean zooplankton available *before* the pond is stocked.
- (4) Monitor the ponds for zooplankton populations *at least* before stocking fish.

Striped Bass and Hybrid Striped Bass Rearing Pond Activity Chart

Days Pre-stocking Activity

- 15 Spray pond bottom with approved herbicide.
- 13 Fill ponds, add initial organic fertilizer application, zooplankton inoculation, zooplankton sample.
- 12 Zooplankton sample.
- 10 Liquid inorganic fertilizer application, zooplankton sample.
- 9 Apply liquid inorganic fertilizer, initiate oxygen and temperature monitoring.
- 7 Take Secchi disk (chlorophyll) readings, apply liquid fertilizer.
- 6 Zooplankton inoculation.
- 5 Secchi disk readings, apply organic and liquid inorganic fertilizers.
- 3 Zooplankton sample.
- 2 Organic fertilizer, zooplankton inoculation.
- 0 Stock fish, zooplankton sample, Secchi disk.

Days Post-Stocking Activity

- 2 Secchi disk readings, liquid and organic fertilizer applications.
- 5 Take Secchi disk readings, apply liquid and organic fertilizers.
- 7 Sample fish and zooplankton.
- 11 Take Secchi disk, apply liquid and organic fertilizers.
- 14 Sample fish and zooplankton, take Secchi disk readings, apply liquid and organic fertilizers.
- 17 Take Secchi disk readings, apply liquid and organic fertilizers.
- 21 Begin supplemental feeding, sample fish and zooplankton, add more liquid or organic fertilizer if needed.
- 28 Sample fish.
- 35 Sample fish, start harvest if fish are large enough (1.25-1.5 inches) or zooplankton food supply is depleted.

Pond Culture of Phase I Striped Bass Fingerlings

Daniel L. Brewer and Robert A. Rees

Striped bass (*Morone saxatilis*) and hybrid striped bass culture can be divided into four distinct phases of production: (1) the hatchery phase; (2) phase I culture, the fry to fingerling phase where fry are reared for 30 to 60 days and obtain lengths of 1 to 2.5 inches; (3) phase II culture, where phase I fish are reared from 5 to 9 months and grow to 3 to 10 inches long; and (4) phase III culture, which is basically grow-out of yearlings to subadult or adult fish. In this chapter we will discuss the specifics of phase I culture of striped bass in fresh water, while brackish water culture, hybrid culture, and phase II and III culture will be found in later chapters.

Over the last 20 years, fingerling production has gradually improved. During the 1970s, harvests of 30,000-35,000 fish and 30-40 pounds per acre were considered average in the southeast. By the early 1980s, average harvests had increased to 40,000-45,000 fish and 40-50 pounds per acre. In 1986, a survey of twelve successful hatcheries located in the southeast (two federal and ten state hatcheries) (D. L. Brewer, unpublished data) revealed that during 1984-1985 the average production at these hatcheries was 48,000 striped bass, or 49 pounds per acre. Concurrent production of hybrid striped bass was 55,000 fish or 62 pounds per acre. In 1983, researchers at the Southeastern Fish Cultural Laboratory, Marion, Alabama, achieved an average production of 80,000 phase I striped bass per acre (150 pounds) from 0.05-acre ponds (Fitzmayer et al. 1986).

Pond Preparation

Planning

Many variables should be monitored and recorded each season, including temperature, dissolved oxygen (DO), pH, total hardness, total alkalinity, turbidity, and zooplankton. Culturists should review past production records to identify factors that contribute to good production. Whenever possible, carefully designed experiments should be undertaken to solve site specific rearing problems. It is also important to keep time and material records for economic evaluation and accounting purposes.

Careful consideration should be given to pond selection. Each hatchery may have specific ponds that are better suited for phase I culture because of soil chemistry, location with respect to wind direction or solar radiation, size, age, and production history. The past history of a given pond, regarding species use, may be important. For example, ponds which have been used for culture of channel catfish (*Ictalurus punctatus*) are sometimes very productive for striped bass.

Pre-Season Pond Preparations

During winter, it may be advisable to dry the ponds. Drying and disking promote soil aeration and organic decomposition, thereby improving water quality and decreasing potential problems with blue-green and filamentous algae. Disking is especially desirable for ponds with nutrient rich "mucky" bottom layers. Disking is not recommended for new ponds or ponds with sandy, permeable soils because the disturbance may increase leakage.

The management practices of drying and disking must be weighed against potential erosion of berms and pond bottoms with winter rains. As possible mitigation to the problem of erosion, light seeding with overwinter cover crops (such as ryegrass) can reduce pond erosion. Seeding at rates of 1-3 pounds per acre is adequate, especially if the seed is sowed over the most susceptible areas. Sowing is usually done in the early fall on recently drained, wet pond bottoms.

Most striped bass culturists do not sow cover crops because the resultant vegetation is an unpredictable source of nutrients to the planned fertilization program and could cause a biological oxygen demand (BOD) problem. In general, removing aquatic or terrestrial vegetation before the pond is filled appears to reduce growth of filamentous algae.

Pre-Filling Chemical Treatments

The use of chemicals for pre-season pond sterilization to reduce infectious organisms and parasites, insects, and other invertebrate pests, has been minimal in striped bass culture, although this practice is now receiving more attention. Possible treatments for sterilization include hydrated or slaked lime added to the soil (Huner and Dupree 1984), or potassium permanganate applied to partially filled ponds.

Ponds should be periodically limed to stabilize pond pH and improve the efficacy of certain chemicals where the water supply is soft (hardness or total alkalinity concentrations below 20 ppm), or the soil is relatively acidic (soil pH below 6.5). Rates are based on soil sample analysis (Boyd 1979) and usually vary from 1,000-2,000 pounds of agricultural limestone per acre with a rate of 1,000 pounds per acre being the most common. Lime is typically applied before the pond is filled and seems to work best where it is used over several seasons. Liming has also reduced blue-green algae problems (Bonn et al. 1976).

Herbicides can be applied to ponds before or at the time of filling. The potential benefits of such vegetation control must be weighed against the harmful effects on zooplankton and possible reduction of DO.

In general, the most noxious aquatic vegetation found in striped bass ponds is blue-green and filamentous green algae. Several chemicals have proven effective in control, including copper compounds and Aquazine®. It is mandatory to determine and abide by all state and federal regulations regarding chemical usage.

Aquazine® at rates of 5-15 pounds per acre has been used to reduce filamentous algal problems. Snow (1979) sprayed it on a dry pond bottom at a rate of 10 pounds per acre. Aquazine® can also be simply poured into the influent water from a shallow-end supply pipe. We recommend that Aquazine® be applied at least 1 week before fry are stocked. Some culturists do not use pre-emergent vegetation control, because chemicals may have short-term and long-term effects on pond productivity (Fitzmayer et al. 1982, 1985).

Filling Ponds

Techniques of pond filling will depend on the water source. In 1980, about two-thirds of striped bass hatcheries had surface water sources and the rest used ground water.

Filtering supply water. Surface water is usually filtered through saran cloth to remove predacious insects and wild fish. The cloth is normally sewn into a sock or fitted to a filter box. Filter size depends on water quantity and the amount of particulate matter. Standard cloth mesh size is 250- 500 μm ; the smaller size offers added protection but requires more frequent cleaning.

If wild fish are present in a pond, they can be killed with rotenone (0.5-2.0 ppm, initial concentration). Rotenone is detoxified with potassium permanganate at a usual application rate of 2 ppm of potassium permanganate to 1 ppm of rotenone. The efficacy of potassium permanganate as a detoxicant is dependent on the organic demand on the chemical: the higher the organic load in the pond, the higher the demand on the chemical.

Timing of filling. Time of pond filling depends on available water and the pond fertilization regime (see Chapter 7). Surface waters usually carry nutrient loads and have an established zooplankton base, so ponds can be filled closer to the time of stocking. Ponds filled with well water usually need to be inoculated and require more time to develop adequate zooplankton densities.

Time of filling also depends on the management strategy for dealing with nuisance algae and pests. If ponds are filled immediately before fry stocking, there is less time for the development of predacious insects, fairy shrimp, and filamentous algae. Conversely, waiting until the last minute to fill ponds usually does not provide time for the plankton populations to develop. In addition, if pre-stocking chemicals are applied for the control of such pests, adequate lead time before stocking must be allowed for recovery of zooplankton and water quality.

The number of days ponds are full before stocking range from 0-2 or more weeks (see Chapter 7). In 1986, ponds were filled 5-10 days before stocking at many successful hatcheries (D. L. Brewer, unpublished data).

Variations of filling. Most striped bass ponds are filled before stocking, although a few hatcheries partially fill ponds (about two-thirds full) to allow for the addition of cool, oxygenated water at the time of stocking. Other culturists stock fry as the pond is filling; this technique may include a preliminary period during which the pond is fertilized and the pond bottom is partially covered with water for a week or so (the "puddle method" for zooplankton enhancement). Stocking the pond as it is filling risks possible extremes in pond temperature and pH. Because stocked fry are confined to a small volume of pond water, there can be increased danger from predacious insects, and nuisance algae may be enhanced by light penetration to the pond bottom.

Treatments for Insects and Other Invertebrate Pests

Pest control treatments normally involve the use of chemicals. Whenever chemicals are used in an aquatic environment, all federal and state regulations must be followed, and only those chemicals registered and approved for aquatic use should be used (Schnick et al. 1986). Caution must always be exercised to protect employee health. Chemical treatments should be used only as needed, and should not become routine, because treatments also may reduce zooplankton and beneficial insect populations. *Always read and follow label instructions.*

Control of predacious insects. Predacious aquatic insects include those which rise to the surface for air (e.g., backswimmers, water boatmen, and predacious diving beetles); those which breathe through gill-like structures (dragonfly naiads); and those which respire through the skin (phantom midge larvae). These insects pose a danger to fry. Starling (1985) reported that predacious insects are the worst enemy of hybrid fry from females other than striped bass, which are much smaller than striped bass or striped bass female hybrid fry.

Air-breathing predacious insects can be killed by applying diesel fuel (Number 2 fuel oil) to create an oil film on the water, which prevents the insects from obtaining access to atmospheric air thereby suffocating them. Rates vary from 2-5 gallons per surface acre, but the lower rates should be tried first. Some culturists add 1 quart of gasoline or burnt motor oil to the diesel fuel to act as a "surfactant" which in turn provides more uniform coverage over the pond surface.

Treatments are applied by spraying or pouring the fuel onto the water surface; they are effective only when applied during calm periods. Diesel fuel can be applied immediately before stocking and, if needed, at 3-day intervals until fry are able to evade predation. Because diesel fuel contains volatile hydrocarbon compounds which can potentially harm zooplankton and striped bass, air should be bubbled through the diesel fuel for 24 hours before treatment to drive off such compounds. Again, it is important to be sure all state and federal permit requirements are met.

Dragonfly and phantom midge larvae may be killed with some of the insecticides used for mosquito control. Non-surfacing insects can be killed with 0.25 ppm Masoten^R (Piper et al. 1982). Insecticides are seldom used in striped bass culture and, if used, should be applied no later than 7 days before fry stocking to allow zooplankton recovery. It will probably be benefi-

cial to inoculate any pond with zooplankton that has been treated with Masoten®. With all chemicals, extreme care must be exercised to assure safety of personnel.

Control of invertebrate pests. Invertebrate pests include snails, crawfish, clam shrimp, and fairy shrimp; which either are intermediate hosts for certain parasites, such as the snails, or potentially compete with striped bass for food and can be a problem at harvest. Snail control can be accomplished through the use of copper sulfate and subsequent liming after filling the pond approximately 10 inches deep.

Crawfish control can be achieved by drying the ponds and treating depressions with calcium hypochlorite (HTH) between crops. Crawfish have also been controlled by Baytex® at 0.10-0.25 ppm (Piper et al. 1982), with the lower rate tried first (*caution must be exercised with all insecticides regarding their registration status*). Baytex should be mixed and spread over the entire pond at least 10 days before harvest to allow time for dead crawfish to decay. We emphasize that this type of treatment reduces zooplankton populations, and zooplankton and crawfish decomposition can reduce DO levels.

Clam shrimp increase turbidity, reduce DO, and clog screens. Control can be achieved with Masoten® at 0.12 ppm applied well before fry stocking (McCraren et al. 1979), or 0.06 ppm or less, 2 weeks after fry are stocked. The latter should have no affect on the fish, but may decrease zooplankton. Masoten® is currently under status review and is presently limited to non-food fish use only. Also, the action of Masoten® in water is dependent on temperature and pH, with high temperature and pH lowering its efficacy (McCraren and Phillips 1979).

Fairy shrimp compete with striped bass fry for food, complicate harvest procedures by fouling drain screens, and cause problems in separating shrimp from fingerling fish. Under research conditions, partial control was achieved with potassium permanganate at 1 ppm, or with Masoten® at 0.25 ppm (Moss 1978), but both chemicals can negatively affect zooplankton. Treatment with 0.5-1.0 ppm potassium permanganate, before and after fry stocking, has resulted in partial control. On rare occasions, Masoten® has been applied at rates less than 0.1 ppm after fry were in ponds for at least 5 days. The chemical was applied only at the shallow end of the pond 2-3 hours before dark.

At one hatchery with a history of fairy shrimp problems, ponds were limed in 1986 with hydrated lime and fairy shrimp problems were not experienced that year. Hydrated or slaked lime is caustic and due care is required (Snow and Jones 1961).

Water Quality Management

Temperature

Five-day-old striped bass fry reportedly survive temperatures ranging from 55-75°F, with optimal temperatures ranging from 64-68°F (Kerby 1986). Temperatures below 55°F and above 75°F are considered detrimental. Temperature tolerance may depend on age of fry, prevailing hatching temperatures, and water quality characteristics. Tolerance can be increased by acclimation.

Temperature tolerance also increases during the transition from fry to fingerling. At 9-10 days of age, fry apparently tolerate temperatures up to 80°F (C. J. Turner, Alabama Department of Conservation and Natural Resources, personal communication). As the fry age, temperatures between 65 and 86°F are considered acceptable, but the mid-range is preferred for growth and survival (Parker 1984; Kerby 1986). At the warmer temperatures, disease problems often increase. Hybrid striped bass appear to be more thermally adaptable than striped bass, and optimum temperatures for their growth may be higher.

Light Intensity

Light intensity affects behavior and possibly fry survival. Rees and Cook (1985a) found that direct sunlight reduced fry survival in aquarium and pond experiments. In their ponds, partial shading with black plastic improved fry survival. Fry and fingerlings often exhibit a hyperactive response to sudden increases in light intensity, and culturists should avoid sudden changes in light to prevent shock.

Dissolved Oxygen

Dissolved oxygen is the chemical factor that most frequently becomes limiting in striped bass culture. Ideally, DO should always be maintained above 6 ppm. Caution should be exercised when adding organic fertilizer to a pond with DO concentrations less than 6 ppm at mid-depth due to increased BOD (see Chapter 7). Oxygen concentrations below 3 ppm usually require supplemental aeration. A number of culturists have had DO drop below 2 ppm for short periods of time without apparent effects on production when they implement prompt, remedial action.

Dissolved oxygen measurements should be taken just before or at sunrise, which is when the concentration will be at its lowest. If DO is monitored twice daily, the second measurement should be at about 1600 hours when DO should be near its peak. At most facilities, DO is monitored daily to several times per week, and a few monitor twice daily. The depth at which oxygen is checked varies, but measurements 1 foot below the surface, combined with measurements near mid-depth and near the bottom, are helpful in determining oxygen stratification.

Heavily fertilized ponds may suffer oxygen depletion at night, so careful monitoring of such ponds is necessary (see Boyd 1979). Ponds with extreme fluctuations in DO between morning and afternoon, or ponds in which DO decreases over several days should receive immediate remedial action to prevent an oxygen depletion. Ponds which clear up suddenly, and those in which DO does not rise between sunrise and noon are also in imminent danger of DO depletion problems.

Before, or during, periods of adverse weather (cloudy, windless, hot), adjustments should be made to fertilization and feeding schedules. Oxygen levels should be checked at least daily during these periods.

Emergency aeration can be supplied by adding fresh water or by using spray-type or paddle wheel aerators (see Chapter 12). Adding fresh water is the most common technique, and is effective if the water supply is abundant and oxygen rich (well water is usually not a good source of oxygen). Supplying water does not always yield quick results: it can dilute nutrients, and may promote growth of filamentous algae. Adding water is sometimes combined with partial pond drainage by releasing bottom water which is usually hypoxic or anoxic.

pH

A neutral or slightly basic pH, 7.0-8.5, is considered favorable for phase I culture (optimal pH is 7.3). Striped bass tolerances of acidity have not been well defined, but acidic (<6.5), as well as basic (>10.0) conditions may be lethal, and should be avoided. Sudden pH changes should be avoided because they have resulted in losses of fry and fingerlings. Striped bass fry are regarded as being highly susceptible to pH changes. Stabilizing soil pH by adding agricultural lime (see Boyd 1979) will assist in phytoplankton management, so pond bottom pH should be checked at least biannually to adjust for acidity.

Water supplies which are slightly acidic can also present problems. For example, one hatchery experienced fry mortality during pond stocking because of the pH difference between holding house (pH 6.5) and pond water (pH 8.0) (M. C. Ray, North Carolina Wildlife Resources Commission, personal communication). This situation was alleviated by pumping pond water into the holding house to provide acclimation. At harvest, a difference between high pH pond water and tank water with lower pH can cause losses. In such cases, pond water pH should be reduced before harvest. (See section on vegetation control.)

Alkalinity and Hardness

Waters high in alkalinity tend to be more strongly buffered than waters with low alkalinity, and well-buffered waters are less likely to undergo sudden changes in pH. Well-buffered waters with an alkalinity of 150-300 ppm CaCO_3 are regarded as excellent for phase I culture.

Hardness relates to the amount of calcium, magnesium, and similar elements in the water, and can be important in phase I culture. Fish do not tolerate handling very well in very soft water, and this is especially true for ultra-soft water (hardness <4 ppm as CaCO_3). Manziara and Starling (1976) found that the addition of 150 ppm calcium chloride, plus 150 ppm magnesium sulfate, to containment water improved hardness.

Stress problems resulting in mortality have also occurred in striped bass and hybrids when handling fish transferred from hard water (>300 ppm) to very soft water (<20 ppm). Hybrids are somewhat more tolerant than striped bass to soft water, but should not be subjected to radical changes in water hardness.

It is generally accepted that water with a total hardness greater than 150 ppm is very good for phase I culture. Under hatchery conditions, excellent phase I crops have been reared in fresh water ranging in hardness from 60-600 ppm.

Alkalinity and hardness can be increased by liming — the amount of increase is related to soil pH. The effects of many chemicals are directly related to alkalinity and hardness, with both efficacy and fish survival improving with increased levels. For example, copper sulfate is more toxic to fish in soft waters.

Salinity

Brackish water is excellent for rearing striped bass and hybrid fingerlings. Geiger and Parker (1985) found that salinities ranging from 0.5-10 ppt positively influenced striped bass production. After fingerlings are fully scaled, salinity may be increased to full strength sea water (ca 35 ppt). Brackish water culture is discussed in Chapter 15.

Pond Stocking

Age at Stocking

Most culturists stock 5- to 10-day-old fry into ponds. By two days of age, depending on temperature, striped bass should be able to maintain themselves horizontally and overcome minor currents. Five-day-old striped bass fry are about 0.25 inches long, and by 5 days of age, the mouth parts and gut should be complete with the fry starting to eat.

In 1986, about 60% of the southeastern state agencies stocked fry at 5 (4 to 6) days of age; yet, several state and many federal facilities held and fed fry until they reached 7 to 10 days of age before stocking (D. L. Brewer, unpublished data). Holding fry allows for more flexibility in stocking, which can result in better timing in relation to pond zooplankton densities. It also allows for checking for air bladder inflation, which can usually be detected by 7 days of age at 68°F. Some culturists stock older, more developed fry because they believe it results in more predictable survival in their ponds; however, extending the holding period requires greater manpower needs and costs associated with the proper care and feeding of fry. Furthermore, there is some evidence to suggest that holding fry may result in decreased air bladder inflation. Recently, the trend has been to move away from holding and feeding fry, as many agencies achieve suitable survival in their ponds by stocking 5-day-old fry.

Historically, striped bass culturists have not stocked sac fry (prolarvae, less than 4 days of age) directly into ponds because of the concern that they would settle to anoxic bottom zones of the pond or would be very vulnerable to predation. However, Harrell (1985) stocked and compared 1-day-old sac fry to 7-day-old fry and found that the 1-day-old fish did better in growth and survival. His 1-day-old fish were a full 24+ hours old and could maintain themselves adequately in the water column. Striped bass in the sac fry and fry stages are especially sensitive to handling and other stressors, and should receive all due care.

Receipt and Handling of Fry

It is often necessary for a hatchery to obtain fry from another facility, and it is helpful if the donor and receiving facilities have similar water quality and temperature, but this is rarely the case. Therefore, it is essential to know the water quality characteristics of the shipping hatchery, and for the receiving hatchery to match those variables to the greatest degree possible.

Transport. Standard shipping procedures are described in Chapter 5. It is most common to ship fish at 1-2 days of age and at 5 days of age. It is best if transport is for the shortest duration possible, because water quality in shipping containers quickly deteriorates after about 18 hours; therefore, every effort should be made to make the shipments for less than 18 hours. Transport by commercial air is usually reliable, but can be disappointing or disastrous when delays extend shipping time. It is preferable to keep the transport water below 70°F by adding up to 0.75 pounds of cubed ice between the box and shipping bag if the water temperature is 75°F or warmer (less ice, if temperature is lower) (R. M. Harrell, University of Maryland, personal communication). Late in the spawning season, when ambient temperatures for hatching and holding are warmer, it may be feasible to ship for short durations at or above 70°F — this might be done if the receiving waters are unusually warm.

Care of sac fry: inside tanks. Sac fry should be placed in indoor aquaria or tanks as described in Chapter 5. On arrival, the plastic shipping bags should be removed from the box (out of bright sunlight) and floated in the receiving water for thermal acclimation. It is general practice to conduct such tempering in subdued lighting, away from direct sunlight. After tempering, techniques for release vary, depending on how much water quality differs between bag and tank water. Some culturists simply open the bag and immediately release the fish, whereas others gradually exchange water for a minimum of one hour. Variations of the latter include introducing tank water into the bag through aquarium tubing for 30-45 minutes, or punching holes in the bag above and below the water line to allow water exchange for about 30 minutes. Whatever the tempering technique, it should be remembered that ideally water temperature in the bag should equal that of the receiving water, and the general water quality inside a shipping bag rapidly deteriorates once it is opened. The water in bags should not be mechanically aerated as this aeration drives off carbon dioxide, resulting in pH increases which increases ammonia toxicity.

Care of sac fry: outside cages. In some instances, sac fry are stocked in cages placed in ponds (Inslee 1979). Cages are made of materials such as saran or nitex. They should be at least 3 feet deep and the bottom of the cage should be at least 1 foot off the pond bottom. Cages should be placed in areas with little or no current; shading enhances survival. Loading rates are about 76,500 fry per cubic yard of cage. When fry develop the ability to swim freely, cages are submerged to allow them to escape. Advantages of cage culture include reduced needs for labor and facilities. Disadvantages include less control of ambient conditions, such as temperature. At present, holding in cages is not widely used.

Quality of fry. Culturists should take note of the quality of their fry. Deformed fry are not common (probably <5% of the total), but high incidences occasionally occur in individual lots. Abnormalities can be found in various forms: failure of the gas bladder to inflate ("stargazer" syndrome); scoliosis (deformed spine with crooked, curved, or s-shaped back [Figure 8.1]); deformed head ("pug-nosed" or "pug-headed"); and truncation ("stub-tailed" see Figure 5.16). It is not uncommon for fish with lesser degrees of abnormalities to survive harvest and stocking to the wild, but they are obviously not a desired product.

Certain conditions tend to promote high quality fry. Fish spawned at the "peak" of the season usually produce fry of more consistent quality. Brood fish from certain rivers or lakes sometimes tend to produce better fry. Large, robust brood fish are preferred over fish in poor condition. Eggs with high fertilization and hatch rates often produce excellent fry.

Care of fry. If fry are held past 4 or 5 days of age, they need to be fed and cared for as described in Chapters 5 and 10. Typically, fry are held in 20- to 90-gallon containers. Before use, the containers should be thoroughly scrubbed with a biodegradable detergent followed by a 3% saltwater bath for 2-3 hours, or acid washed with muriatic acid, and rinsed with fresh water. Thorough cleaning can help prevent fungus and bacterial outbreaks. The tanks can be sterilized by cleaning them with a dilute solution of household bleach. If this method is used, they should be thoroughly rinsed and allowed to dry to remove residual chlorine before use.

Each container should have a removable standpipe surrounded by an appropriate screen and a "bubble curtain." Influent water is usually added at 1-3 gallons per minute. Fry are normally held at 4,000-6,000 per gallon, but concentrations as high as 30,000 per gallon can be used for short holding periods. Brine shrimp nauplii (*Artemia*) ideally should be fed to striped bass larvae every 15 minutes to a minimum of every 3-4 hours (see Chapter 10 for further feeding information). Screens should be cleaned as necessary to remove brine shrimp egg shells, dead shrimp and fry, and other debris.

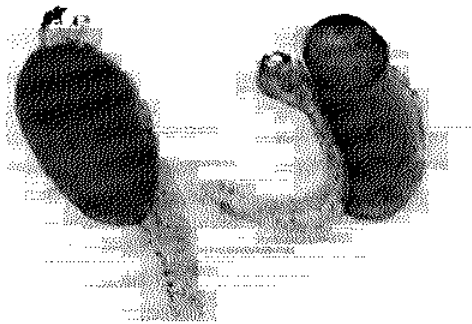

Figure 8.1. Abnormal striped bass fry exhibiting scoliosis. Photo Credit: Reginal M. Harrell.

Container bottoms can be periodically siphoned using a glass or plexiglass tube fitted with flexible tubing. Flow is controlled by squeezing the flexible tubing or by placing a finger over the discharge end to prevent siphoning of fry. Surface oil and scum can be removed by slowly drawing a piece of wax paper or oil absorbing cloth across the surface, with the paper tilted at about 45° from the vertical. Survival during this period usually ranges from fair (≈50%) to excellent (over 90%).

Pond Stocking Rates

Pond stocking rates vary from 50,000-600,000 fry per acre. Most agencies routinely stock 100,000-250,000 fry per acre in ponds designed for phase I production for stock enhancement efforts. Stocking rates for commercial fingerling production tend to be about 50% lower than recreational fingerling stocking protocols. The primary difference is geared toward size at harvest with the lower densities resulting in larger fish. In general, stocking rates depend on (1) fry availability, (2) expected survival rate, and (3) the number and size of fish needed at harvest. Survival during the fry-to-fingerling stage varies, but averages of 25-40% are typical.

Stocking rates are usually based on the goal of rearing the maximum number of a targeted size fingerling. Target sizes for phase I fish range from 1.0-2.5 inches long, and are based on management requests or needs for phase II culture. Stocking rates used to achieve target goals at three state hatcheries during 1985 are presented in Table 8.1. Each hatchery had from 12-22 acres in phase I production, and stocked 5- to 7-day-old fry.

Geiger and Parker (1985) recommended stocking rates of approximately 160,000 fry/acre in freshwater ponds, and 240,000 fry/acre in brackish ponds. These rates were recommended for production of fish about 1.5 inches long (700-1,000/pound). The state hatchery at Marion, Alabama, has been one of the more successful hatcheries rearing this size of fingerling. By stocking 150,000 9-day-old fry per acre, this facility produced 75,000-80,000 phase I fingerlings/acre which weighed 800-850/pound during 1984-85 (C. J. Turner, Alabama Department of Conservation and Natural Resources, personal communication).

Rees and Cook (1985b) investigated the potential of increasing fingerling production through the use of high stocking rates. They found that rates of about 750,000 fry/acre should yield 200,000 1-inch fingerlings/acre in 35-42 days. Currently, Georgia routinely stocks 300,000-600,000 fry/acre. Similar rates, 250,000-600,000 fry/acre, have been stocked in brackish ponds (Minton 1982).

Time of Stocking

Nearly all culturists stock ponds at night. Stocking is usually started after sunset or before sunrise, depending on pond temperature, DO concentration, and pH. In most cases, shipment of fry of stocking age arrive during daylight hours, and some culturists elect to stock on arrival to avoid the extra handling of placing the fry into tanks or to avoid prolonged holding in shipping containers. This is not recommended, but if it is necessary, the fry should be shaded as much as possible because direct sunlight is detrimental to fry survival (Rees and Cook 1985a).

Table 8.1. Stocking rates used to achieve targeted production of phase I striped bass and hybrid fingerlings at three different state hatcheries in 1985.

Hatchery	Number of fry stocked per acre	Number and weight of fish harvested per acre	Size at harvest
Richmond Hill, GA	300,000+	96,000 62 pounds	1550/pound 1.2 inches
Clark, KY	160,000	64,000 114 pounds	600/pound 1.7 inches
Eagle Bend, TN	100,000	35,000 178 pounds	200/pound 2.5 inches

Stocking Technique

Preparation. Fry should be enumerated using variations of the volumetric sampling method described in Chapter 5. Holding water and pond water should be checked for temperature and other water quality characteristics, and the two equalized as much as possible.

When fry are 5 to 7 days old, pond temperatures of 66-68°F appear to be optimal for stocking success, and culturists generally consider the range of 60-72°F suitable. Pond temperatures >75°F are undesirable, but moderate success can be achieved with proper tempering. Pond temperatures exceeding 80°F are a real challenge, but fair success has been achieved with considerable tempering (several hours to days). Ideally, temperature change should not exceed 4°F per hour.

Tempering and stocking. Tempering can be more easily and successfully accomplished in aquaria or tanks by pumping filtered pond water to the holding building. This technique is usually very successful, particularly if tempering occurs over 4 to 8 hours or more.

Fry can be transported to the pond in plastic shipping bags filled with water and oxygen or in containers such as plastic buckets or tubs (with or without aeration). Aeration can be supplied to the containers with an aquarium air pump if electricity is available, or with compressed air or oxygen from a small oxygen cylinder with an appropriate regulator.

When stocking at night, bags should be floated in the pond for at least 10-15 minutes to allow temperature acclimation. The bags should be moved occasionally during this period

rather than left still. When the bags are opened, the pure oxygen atmosphere will escape, and tempering should proceed steadily.

Tempering time varies, depending on water quality differences, but can take up to an hour or more. Slowly add pond water to the bag until it is full, then empty the bag keeping in mind that wrinkles and folds in the bags can trap larvae. Bags or tubs can be allowed to sink into the water and the fish allowed to gradually acclimate. After acclimation, the bags should be turned to their side and the fry are allowed to escape.

Another technique is to submerge weighted containers (e.g., 25- to 40-gallon plastic trash cans) filled with holding water, and allow fry to escape. This technique allows slow mixing of pond and container water, but the fry may be subject to predation so screening may be necessary.

If fry must be stocked during daylight hours, they should be protected from direct sunlight and overheating (i.e., plastic bags can act as a greenhouse and cause rapid water warming). Sometimes it is advantageous to submerge the bag or container in cooler water and then release the fish.

Fry are usually released at the deep end of the pond, but some culturists release them along a side of the pond. Release is usually at the pond surface, or at 1-2 feet under the surface.

Methods of Determining Survival

Attraction to light. Fry survival is usually checked at night using lights, such as a Q-beam® or other 12-volt sealed beam light, or flashlights. If a light beam is directed into the water and held still, in a few minutes fry should appear within the lighted area. Evaluations are based on the relative numbers of fry counted per specified time period. Depending on the experience of the evaluator, this method is generally regarded as moderately reliable to reliable. Each pond is usually checked 3 to 10 days after stocking unless the pond is stocked with fry produced from females other than striped bass (see Chapter 11). In some cases, checks are made one hour after stocking, again one day after stocking, and then once a week for two weeks.

Tow net. Fry survival can also be evaluated with the use of a tow net. The net normally used has a mesh of about 1 mm and a mouth opening of 0.5 square meters (Turner 1984), and is pulled approximately 50 feet through the surface water of each pond. Tows are made from 0700-0800 hours at 1.5-3.0 feet/second. If numbers captured are low, a second tow is made. If they are still low, a night tow is made in combination with a Q-beam® check. Tows should be made within about 36 hours after stocking if fry 8 to 10 days old are stocked, or they will be large enough to escape the net.

Seining. Seine checks can be made at 7 to 10 days after stocking. Seines are up to 20 feet long and have 1/16-inch mesh. At this time, fry are still very small and transparent, so detection is easier if you try to focus on the eyes of the fry, not the entire body.

Confined sample. At stocking, a sample of fry can be placed into a partially-submerged box made of screen or saran (mesh size of 500 μm is small enough). We recommend that the box rest near the bottom so factors affecting survival will be similar to those in the open pond. Fry are left in the box for a few hours to several days and then observed. It is difficult to place a box in a pond in such a way to simulate overall pond conditions, so the use of confined samples is not common and is regarded as somewhat unreliable.

Restocking

If fry survival cannot be confirmed, the culturist may wish to re-stock the pond. The procedure for re-stocking a pond with failed survival depends on availability of fry, and the cause of the initial failure. If failure is attributed to poor fry quality or stress during stocking, the pond may be restocked if the zooplankton population is adequate. If failure is judged to be the result of insect predation or inadequate zooplankton, the pond should be drained and a new start made.

Pond Management

To maximize production in culture ponds it is essential that the culturist maintain as optimal conditions in the pond as possible. This often means controlling undesirable plants and animals, manipulating of the food availability (including supplemental feeding), and sampling for growth and condition of the fish.

Vegetation Control

Filamentous algae can be a serious problem in striped bass ponds because they divert nutrients from the desired food chain, and striped bass fry and fingerlings can die from entrapment. At harvest, filamentous algae clog screens; they also contribute to injury or mortality of those fish entrapped in the algae during seine hauls.

Some culturists attempt to reduce filamentous algal problems by shortening the length of time the pond is filled before stocking. In this practice, ponds are filled shortly before stocking, and are harvested as soon as fish reach an acceptable size. Unfortunately, filamentous algae can quickly develop, even in a short time period. Also, the pond may not be filled long enough before stocking to develop an adequate zooplankton bloom.

Biological control. The establishment of a satisfactory phytoplankton bloom within one week of filling the pond can be a very effective means of preventing unwanted vegetation. If carefully managed, the algal bloom will shade the pond bottom and prevent nuisance vegetation from becoming further established (Turner 1984).

Excessive plankton blooms (Secchi disk visibility ≤ 8 inches) are undesirable because of extreme fluctuations in DO concentrations (supersaturation during photosynthesis and depletion during respiration). Dense algal blooms can result in large diurnal fluctuations in pH if the pond is not properly buffered. During photosynthesis the plants may utilize all the carbonates in the water and start assimilating free CO_2 . In these cases, pH could become very high (>10).

Also, if there is an extensive phytoplankton die-off, oxygen depletion is likely due to decomposition of the plant material.

Grass carp (*Ctenopharyngodon idella*) are used at a few hatcheries for vegetation control, particularly where the phase I culture period is relatively long, because the carp have more time to effect control. Grass carp have been stocked at the rates of: (1) 300 per acre at a size of 3 to 5 inches in length; (2) 200 per acre at a size of 4 to 6 inches; or (3) 100 per acre at a size of 6 to 10 inches (D. L. Brewer, unpublished data). Triploid grass carp are now legal in a number of states where diploid grass carp are restricted.

Where pelleted feed is fed to striped bass, moderate amounts may be eaten by the carp. Some culturists report that grass carp can be a problem at harvest because, when confined in a small area, they can physically damage the smaller striped bass. If ponds are drained slowly, striped bass usually come to the harvest kettle before the carp, but when carp and striped bass mix in the kettle, the carp should be quickly removed. In addition to grass carp, tilapia have been successfully used in South Carolina for vegetation control in ponds which were used for extending phase I production (3 to 4 inches) as well as phase II production. Stocking rates were 100, 3- to 4-inch tilapia per acre (R. M. Harrell, University of Maryland, personal communication).

Chemical control. After ponds are stocked, herbicides are sometimes needed to control filamentous algae which can also cause the same water quality problems as dense phytoplankton blooms, especially dense blooms of blue-green algae (Boyd 1979). Both plants can be controlled to some degree by adding accepted algicides at low rates.

All federal and state guidelines regarding chemical use must be followed. The current registration status of each chemical must be determined and all label instructions properly followed. We also recommend that chemical use be delayed until at least three weeks after stocking to reduce effects on fish growth by depleting zooplankton populations.

Chemicals used for aquatic vegetation control include Aquazine® at 1 to 15 pounds per acre, Diquat® at 0.25-1.5 ppm, and Aquathol K® at 0.5-0.75 ppm. For broadleaf vegetation such as smartweed, Rodeo or 2, 4-D have been used. Aquazine® has been used most extensively, but it may have long-term effects on pond productivity (Fitzmayer et al. 1982), and can cause oxygen depletion. Copper sulfate is generally considered unsafe for striped bass in fresh water (Hughes 1969); however, with the shortage of approved herbicides, a few culturists have used copper sulfate (up to 0.5 ppm, depending on water alkalinity) and chelated copper compounds. In brackish water (3-10 ppt) with high alkalinity (>185 ppm) copper sulfate was found to be fairly safe at levels of 2 ppm at the lower salinities (Reardon and Harrell 1990).

Considerable caution is recommended regarding use of copper sulfate or any metal-based herbicide in any water, and a bioassay should be conducted before it is applied to a pond. Bioassays are needed because copper sulfate is more toxic to fish in water with low alkalinity or low pH. Toxicity is also affected by temperature, hardness, and DO (see Boyd 1979).

Control of Nuisance Vertebrates

There is no known practical control for tadpoles in striped bass ponds, although early removal of adult frogs is helpful. A few culturists remove the egg masses as they see them, or dust the eggs with a few crystals of copper sulfate. Turtles may be trapped or baited. Snakes can be reduced by maintaining a clean, mowed, pond bank area, or they may be removed.

Fish-eating birds sometimes can be a serious problem, primarily at harvest (see Chapter 9). Human presence, combined with scare devices, such as racket bombs or down-range exploders, provide some relief. Propane automatic cannons are available for more long-term use, but are uncommon for phase I culture. Most of these birds are protected by federal statutes so if the culturist is planning on control by shooting, a permit must first be obtained.

Alligators can inflict serious human injury. They can also cause fish to become stressed or shock (flair gills and exhibit tetany), and their thrashing in a seine filled with fish can result in substantial fingerling mortality. The only remedy is capture and removal, unless they can be controlled under a nuisance alligator program.

Supplemental Feeding

Supplemental feeding may extend survival and growth of fish that have exhausted their natural forage. Feeding is sometimes conducted as part of a program to rear phase I fish longer than 1.5 inches, and is usually started when fish are 21 to 26 days of age (range 14 to 26 days), or when fish are nearly one inch long. Usually, a dry, high-protein salmon diet is fed. Feeding methods vary from feeding by hand to using blowers or automatic feeders. If fish are fed by hand or blower, it is usual to feed around much of the pond's perimeter 1 to 3 times daily, 7 days per week. Automatic feeders are normally set to feed 16 to 24 times daily.

It is usual to begin with starter diets (#1 crumbles), or even meals (#0 or #00). Early feeding rates are 1 to 5 pounds per acre per day; after a few days rates are increased, thereafter ranging from 5 to 15 pounds per acre per day. The rate should not exceed 30 pounds per acre per day unless suitable water quality can be maintained by dilution or aeration. Feeding should be stopped if DO concentrations drop below 4 ppm. At hatcheries where relatively large phase I fingerlings are reared, #2 and even #3 crumbles are included in the feeding schedule. Fish trained to feed are generally easy to observe and capture. Also, training phase I fish to feed serves as a useful entry into phase II rearing.

Disadvantages of supplemental feeding include the added expense and labor. Part of the feed may be eaten by tadpoles, and unused feed may promote growth of filamentous algae. Heavy feeding can contribute to poor water quality; trained fish may be more subject to bird predation; and growth differential can be found in fish that do not accept artificial feeds. At present, only a few hatcheries routinely use supplemental feeding in phase I culture.

Sampling Fish for Survival and Growth

Most culturists seine ponds when striped bass are 2 to 3 weeks old to check survival and growth. Seines are usually 10 to 20 feet long, with 1/16-inch mesh. Later, ponds are seined to

determine the readiness of fish for harvest. Periodic seine hauls can be made to determine size and condition of fish, to check for disease or parasites, and to determine food habits of fish.

Growth of phase I fish is directly related to food supply, oxygen levels, and temperature. Pond temperature affects growth by influencing zooplankton production and fish metabolism. Oxygen and other water quality characteristics influence the general health of fish. Fish density can influence growth, with greater numbers resulting in increased competition for food and smaller fish. Because of these variables, growth is frequently different between ponds, years, and hatcheries, making it necessary to monitor prevailing conditions in each pond.

Special Rearing Situations

Nursery Ponds

Some agencies currently utilize nursery ponds or small impoundments, ranging from 4 to 80 surface acres. These are usually filled via watershed runoff. If wild fish are a potential problem, rotenone is applied to the pond well before stocking. Fry stocking rates in nursery ponds are generally low (10,000-50,000 fry per acre) and fish are often reared to a larger size than is typical for phase I culture. Labor needs are reduced, because the rearing waters are checked less often. Because nursery ponds are usually situated at a higher elevation than the adjacent receiving waters, harvesting is accomplished by draining the fish directly into the receiving waters thereby reducing handling and stress. A major disadvantage is the inability to determine the number of fish released.

Second Crop Ponds

In many hatcheries, striped bass and hybrids are reared as a single or first crop per individual pond per year. At times they are reared as a second crop, being preceded by an earlier crop of striped bass, hybrids, walleye, or other fish. When double cropping, as it is commonly called, ponds are usually allowed to dry for 1-7 days between crops and, if necessary, harvest kettles or other standing water areas can be treated with rotenone (0.5-2.0 ppm). After a few hours, the rotenone should be detoxified with potassium permanganate (2.0-2.5 ppm). Production results for these ponds are usually less than results for first crop striped bass or hybrids, because second crop rearing often has more problems with warm temperatures, low DO, inadequate zooplankton development, filamentous algae, and parasites and disease.

Pond Harvesting

If culture is successful, fish will be harvested when they reach the targeted size, but it is sometimes necessary to harvest fish early because of premature food depletion, or harvest may need to be managed to coincide with available transportation. Some rearing facilities harvest ponds and stock reservoirs or rivers in conjunction with field reports concerning the availability of forage in the receiving waters. In some instances, it is necessary to adjust culture and harvesting schedules to fulfill the possibility of producing a second crop in the ponds. In commercial culture, harvest corresponds with the readiness and desires of the buyer.

Stress Associated with Harvest

Striped bass are highly susceptible to shock so handling should be minimal and conducted in water whenever possible, and loud or sudden noises should be avoided. Although harvesting usually starts before daylight, or at night, it can also be safely done on cloudy or cool days. Direct sunlight and daytime heat should always be avoided.

Preparation for Harvest

Before pond draining is initiated, water quality should be optimized to the greatest extent possible. This often means adding fresh water, or aerating the pond to improve DO or pH. Where water is abundant and inexpensive, large volumes of water can be added to the pond 1-2 days before draining to begin the acclimation from pond water to holding water.

Algae control. Filamentous algae are often an aggravation at harvest, because they clog drain screens and can entangle striped bass in the catch basin or the pond. Chemical algicides should be applied one week before harvest, and care should be taken to avoid oxygen depletions with decaying plant material. Also, potassium permanganate at 2-4 ppm can be used to "shade out" algae for several days before harvest. The potassium permanganate also oxidizes the decayed plants, thus helping to offset potential DO problems.

Floating algal mats can be removed by using a "boom" device which has wooden floats strung along a rope. The "boom" is pulled across the water surface to entrap algal mats which are then concentrated to one side of the pond and either contained or raked to the bank. Boards may be floated in front of the catch basin area as a barrier to keep algae away from the screen. Block nets have been placed to collect algal mats. Most often though, the pond is simply drained slowly and the catch basin area is frequently cleaned of algae. Striped bass are usually able to work their way through congested water if the pond is drained slowly. These fish also have a tendency to seek the deepest part of a pond during drainage and avoid cover.

Fresh inflowing water and currents can be used to attract the fish near the harvest area. It is ill-advised to drain an algae-infested pond when the wind will blow algae toward the screen.

Prophylactic treatments. Diseased or parasitized fish can present a difficult problem near harvest time. Reliable control is difficult to achieve in the pond, but affected fish are particularly susceptible to the stress of harvest. Chemicals such as potassium permanganate can be safely used to assist in alleviating external parasites and to increase mucous production, which helps guard against further infections (see Chapter 13). If diseases are present, control in the pond should be attempted, followed by a quick and careful harvest. Application of more effective treatments once the fish are in hauling or holding tanks may also be beneficial (see Chapter 13).

Harvest Techniques

Seining kettle or catch basin. The usual method for harvesting phase I fingerlings is by draining the pond and seining into a harvest kettle or catch basin. The pond is usually dewatered as quickly as possible, but not so fast that fish are impinged on the screens. It is best if fresh water can be added to the pond during the entire drawdown period. If DO problems are anticipated, aeration with 1/3-1/2 hp agitators, or by other means, is advised.

The evening before the day of harvest, the water level is usually relatively low (1-3 feet), and many culturists stop draining and add fresh water to the pond. Overnight, striped bass often congregate in the catch basin area because of their attraction to the flow of fresh water. Final drawdown usually begins during the early morning hours, and harvest starts just before or at daylight. Fresh water should always be added to the kettle area during harvest as organic material congregates in the kettle and increases the biological oxygen demand. If possible, this inflow is from the same source that supplies the holding tanks and is cooler than the pond water itself. It is wise not to crowd all of the fish into the catch basin at once because crowding can cause oxygen depletion problems. If crawfish are abundant in the kettle, it may be necessary to seine over the top of them. Fish are seined and eased into tubs or buckets with water for transfer to the distribution truck (Figure 8.2). If fish exhibit stress symptoms (shocking or "piping") during drawdown or harvest, the pond should be rapidly refilled until problems are corrected. While most catch basins are located inside the pond, some hatcheries have external kettles which work well if the pond has a good slope, algae are not a problem, and harvest occurs before the sun gets too high over the horizon. Once the sun is up, it is more difficult to get striped bass to swim with the current and go through the drainage pipe to the external catch basin.

Autocranes (cherry pickers) for harvesting are in use at some hatcheries and are beneficial to crew and fish. A few hatcheries are built so that pond water drains into a ditch or pipe which routes water and fish directly to the holding building.

Glass V-Traps. The glass V-trap (Anderson 1974, Figure 8.3) has proven to be successful in harvesting 1- to 2-inch striped bass from ponds. Up to 80% of the fingerlings can be removed, but more commonly 40-60% are removed (Turner 1984). Harvesting with glass V-traps is considered to be less stressful than other methods, and several agencies employ this technique. Holding facilities must be available for accumulation of the trapped fish.

When pond draining begins, the trap is placed 4-6 inches in front of the drain screen to facilitate screen brushing and fish movement into the trap. When the pond is about one-quarter drained, fish will usually start to trap, and it will be necessary to empty the trap about every 30 minutes. A shallow dip net with knotless webbing is used to remove fingerlings from the trap. Trapping at night with light attractors has produced the best results. A small flow of fresh water introduced into the kettle appears to attract the striped bass (Anderson 1974). Do not leave traps unattended. V-traps can be used to remove up to 70-80% of striped bass from ponds with filamentous algae problems (C. J. Turner, Alabama Department of Conservation and Natural Resources, personal communication). A 1/4 hp agitator is placed so that a stream of water

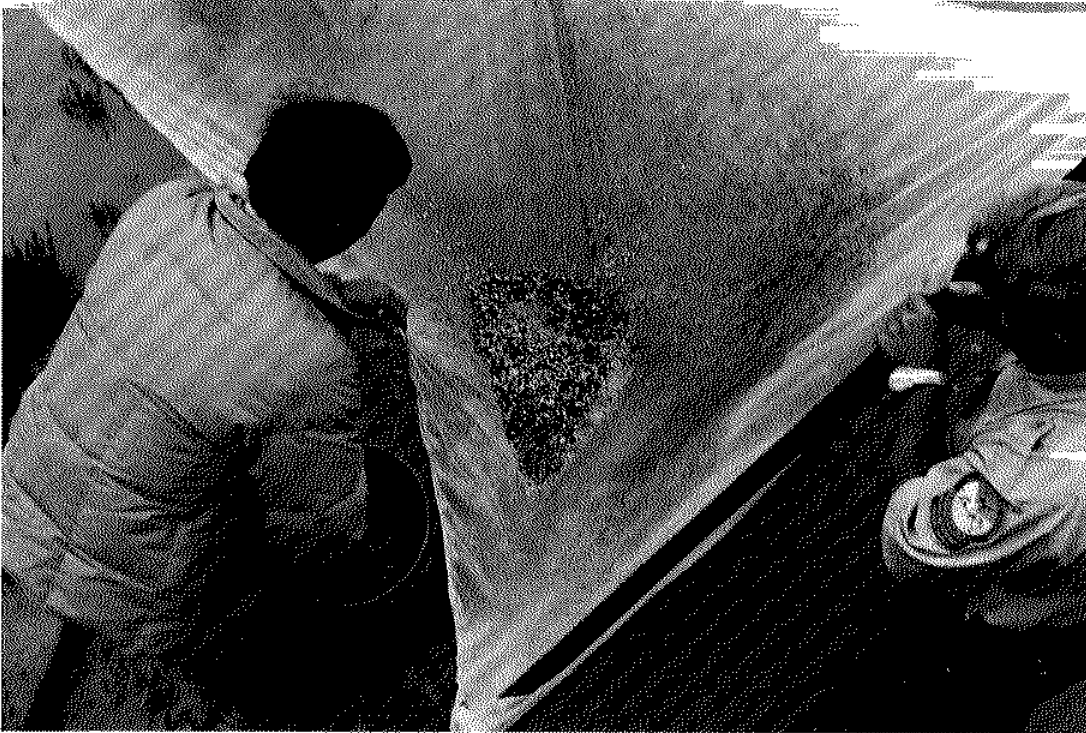

Figure 8.2. Harvesting striped bass from harvest structures with a seine. Photo Credit: Reginal M. Harrell.

flows through the trap, and attracts fish into the trap. Lights may also be set up around the trap to attract the striped bass at night. Such traps can be fished while the pond is very slowly drained, or with the drain valve closed in a partially drained pond. When fish are swimming along the shoreline, several traps may be set perpendicular to the bank with 4- to 6-foot leads to the bank.

Cropping with seines. Seining is sometimes necessary, but it is abrasive and injurious to fingerlings. Seining is particularly harmful if the pond contains significant amounts of filamentous algae, and it also stirs up pond bottoms and tends to destratify and deoxygenate water. Before seining, partial draining is helpful. As with other methods, fish can be concentrated with attractors such as inflowing water, light, and feed.

Treatment for Stress

Culturists almost always add salt to tubs, holding tanks, and truck tanks at a usual concentration of 7.5-10 ppt NaCl during and after harvest to relieve fish stress. Calcium chloride may also be added at a concentration of 75 ppm to relieve stress (Turner 1984). Where water hardness is ultrasoft (<4 ppm CaCO₃), calcium chloride and magnesium sulfate can be added at 150 ppm each. Where calcium is very low (<2 ppm), calcium chloride can be used at 100 ppm Ca, in holding vats to reduce holding stress and mortality (A. C. Mauldin II, Georgia Department of Natural Resources, personal communication). The addition of calcium chloride to ponds with low calcium (<2 ppm) has also reduced post-harvest mortalities (Mauldin et al. 1988).

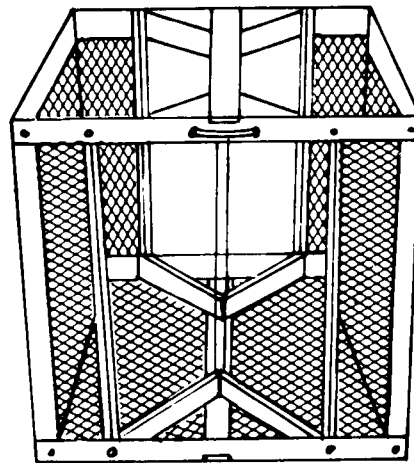

Figure 8.3. Design for glass V-traps used to capture striped bass and striped bass hybrid fingerlings in rearing ponds. From Bonn et al. (1976).

Estimation of Numbers

Harvested fish are weighed in tared (pre-weighed) buckets of water before being placed on the distribution truck. Subsamples are weighed and counted to determine the number of fish per pound. The total weight of the fish harvested are then extrapolated to the number of fish per pound and the total number of fish harvested is estimated. It is important to remove items such as sticks, leaves, tadpoles, crawfish, and turtles from the weighing buckets to obtain accurate measurements.

Water displacement methods can also be used. Samples that displace a known volume of water are counted, then numbers are calculated from total water displacement in the tubs or buckets or from the hauling truck.

Post-Harvesting Handling and Holding

At many facilities, harvested fish are taken to holding tanks to allow flushing of the digestive system, recovery from stress, and to provide disease treatments. At some facilities, holding space is not available so fingerlings must be hauled directly from the pond to stocking sites. Where this is done, special attention should be given to transport water quality because of the effects from metabolic wastes of fish and tadpoles.

Holding Fish

Tank water should be cleaned of algae and trash by siphoning or using a dip net. Tadpoles are usually removed by siphoning, or graders can be used to separate out tadpoles and crawfish. Bar graders of the push-type are often used, but "crowders" or push graders can also be made of hardware cloth. Care should be exercised when using graders to minimize fish stress. Therapeutic treatments with salt and bacteriostats sometimes cause tadpoles to come to the surface where they can be netted.

Fish should be examined for abnormalities, and a notation should be made if any are present. If fish are diseased or parasitized, they should be treated with the proper chemicals (see Chapter 13). Many culturists use 10 ppt NaCl for a few hours as a prophylactic treatment.

Time of holding can vary from several hours to several days, but most striped bass are shipped from the hatchery within 24 to 36 hours after harvest unless they are to be restocked for phase II grow-out. Additional information on holding and transportation is provided in Chapter 12.

If the fish are to be used for further grow-out, or are to be commercially sold, they are usually trained to accept an artificial diet before re-stocking or sale. This training may take from several days to a couple of weeks, and during this time, frequent grading of the fish is recommended because cannibalism can become a serious problem.

Production of Advanced Fingerling and Subadult Striped Bass and Striped Bass Hybrids in Earthen Ponds

Theodore I. J. Smith, Wallace E. Jenkins, and R. Vernon Minton

Production of Phase II Fingerlings

Advanced juveniles (phase II, 3-10 inches) striped bass (*Morone saxatilis*) have been produced on a small scale since 1971 at the Edenton National Fish Hatchery in North Carolina (Atstupenas and Wright 1987). However, in recent years increased emphasis has been placed on phase II production as a component of major stock restoration programs in the Chesapeake Bay and along the Gulf Coast. Increased interest in food fish production has also focused more attention on production of phase II juveniles and commercial phase III (grow-out) market-size fish.

The decision to stock phase I, or the larger phase II juveniles, is usually based on an actual or intuitive cost/benefit ratio. Simply stated, in each case a decision is made with regard to whether it is more cost effective to produce larger (but fewer) phase II fingerlings which have higher survival rates, or to produce larger numbers of the smaller phase I fish, which have a lower survival rate. Stocking of small juveniles is currently preferred by most state agencies. For example, during 1986-1988, average annual production of phase I fingerlings (average size, 1,375 fish per pound or 0.33 g) from 10 states and 8 federal hatcheries was 16 million (Striped Bass Committee production records). In contrast, during the same period, the combined production of 3 states and 8 federal hatcheries was 514,500 advanced juveniles (average size, 12.6 fish per pound or 36 g) per year, 91% of which were striped bass. In coastal stockings, benefits from stocking phase II fish appear greater because more predatory diversity occurs in marine waters and all hatchery fish are tagged before release, which is facilitated by larger fish.

Pond Design

Phase II culture ponds are similar to those used for phase I culture, and range in size from 0.25- 2.5 acres (see Chapter 3). Although a harvest kettle is not required for phase II production, its use can reduce stress. A concrete harvest kettle or catch basin 2-3 feet deep is suitable for harvesting phase II fish (Figures 3.4 and 9.1).

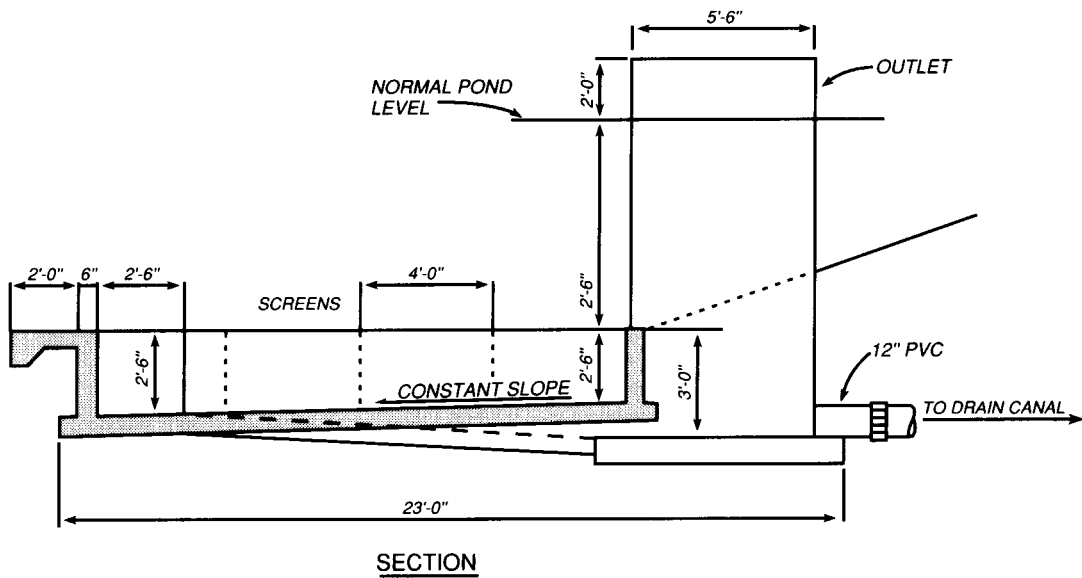
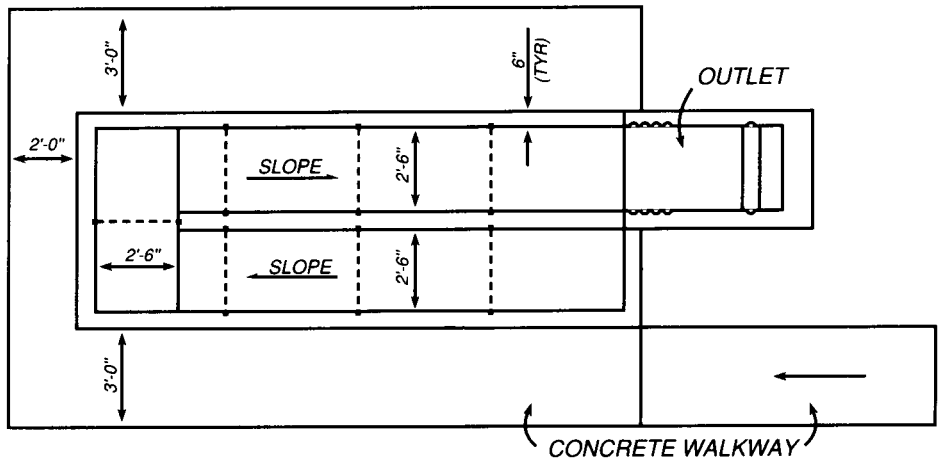

Figure 9.1. Schematic diagram of a sloped-bottom harvest kettle used in South Carolina at the Waddell Mariculture Center.

Pre-Stocking Pond Preparation

Pond preparation for phase II and subadult production is not as involved as for phase I culture (see Chapters 7 and 8 for soil preparations). Indeed, very little preparation is needed for phase II and phase III production ponds. Fertilizers are not used at most facilities during phase II and III production because ponds usually retain enough organic fertilizer from phase I production to produce an initial phytoplankton bloom. Actually, feeding will generally provide sufficient organic matter to stimulate phytoplankton growth; however, organic and inorganic fertilizers can be added to stimulate phytoplankton growth if necessary.

Phytoplankton blooms in phase II and phase III ponds are more important for shading out aquatic vegetation than for primary production of food because zooplankton in the water can distract the fish from learning to feed on artificial diets. Other steps in pond preparation are outlined in Chapters 7 and 8.

Water quality (especially dissolved oxygen [DO], pH, and temperature) should be monitored before stocking to ensure that conditions are satisfactory. Fish should not be stocked before ponds are completely filled because of increased predation pressure by birds and increased stress from sunlight.

Use of Phase I Fingerlings

Phase I juveniles to be stocked into phase II ponds should be fed at frequent intervals for at least two weeks before harvest. The feed should be small enough for the young fish to eat (#1 or #2 salmon crumbles), and should be provided *at least* twice a day, once in the early morning and again in late afternoon (Parker and Geiger 1984).

If the harvested fish are to be stocked directly into phase II ponds, numbers should be estimated at harvest by weighing, and when the number required for a specific receiving pond is obtained, the fish should be immediately stocked. Distributing fish during harvest eliminates additional handling associated with later estimation of numbers and stocking. If the fish are to be held in tanks to train them to eat prepared diets or for prophylactic or disease treatments before re-stocking, numbers should be estimated as harvest progresses, and the fish taken to the holding facility immediately following harvest.

If harvested fish are not relatively uniform in size, they should be graded before re-stocking (Parker and Geiger 1984; Atstuppenas and Wright 1987). Grading during harvesting and loading is best accomplished with floating bar graders. Graders (Figure 9.2) come in a variety of sizes, but we have found that, because the population structure is not often known until harvesting is initiated, variable size graders offer more flexibility than those with constant bar size. They are commercially available or they can be constructed. Care must be used in selecting a variable size grader because fish can become caught in the mechanism of some models, resulting in mortality. Grading increases uniformity of fish, allows more even competition for food, and reduces cannibalism.

Acclimation and Estimation of Mortality

Fish should be acclimated to pond water before stocking if the pH, temperature, alkalinity, hardness, or salinity differ from the transport water. This is accomplished by exchanging water in the hauling tank for at least one hour for every 4°C difference (see Chapter 12). Water is pumped from the pond into the hauling tank while water is removed from the tank by slightly opening a valve or siphoning. The opening to the valve or siphon should be screened to prevent fish from escaping. Dissolved oxygen and temperature should be monitored during the acclimation process. When temperature and pH are similar to that in the pond, the fish can be stocked. A quick release valve, which discharges fish directly into the pond, is preferred to netting them. Fish should be discharged through a hose placed beneath the receiving water's surface, and not allowed to "free fall" from the tank outlet.

Mortality estimates should be conducted on each pond after stocking. These estimates can be made by checking the ponds at sunrise the morning after stocking and counting dead fish. Counts should continue for two or three days, or until no further mortality is observed. If stocking losses are higher than 5%, it may be desirable to stock additional, similar-sized fish to replace mortalities.



Figure 9.2. Adjustable bar grader used to size grade juvenile striped bass and hybrid striped bass. Photo Credit: South Carolina Wildlife and Marine Resources Department.

Stocking Densities

Stocking densities used for culture of phase II striped bass and hybrids range from 4,000-100,000 fish/acre (Kerby et al. 1983a,b, 1987a; Parker and Geiger 1984; Minton 1985; Atstupenas and Wright 1987). During 1986-1988, the average stocking density for hatcheries in the southeast was 22,000 fish/acre. Decisions concerning stocking densities will largely be influenced by production goals, facility equipment, and predation rates. If the objective is to produce large numbers of fish averaging from 11-18 fish per pound (25-41 g), then a high density (25,000-40,000/acre) may be preferred. If fish weighing more than 0.25 pounds are needed, a lower density (10,000-15,000/acre) may be more appropriate. *It is very important to note that availability of supplemental aeration and/or sufficient flow of oxygenated water is required to maintain a large biomass, and will be an important factor in determining appropriate stocking densities for specific facilities.*

In general, stocking at low densities (e.g., 5,000 fish/acre) encourages more size variation with the dominant larger fish consuming most of the food (Atstupenas and Wright 1987). As a result, size distribution at harvest will be bimodal with a large percentage (80%) of small fish (≤ 23 fish per pound or 20 g) and a small percentage of extremely large fish (≥ 0.25 pounds or 100 g). Survival may also be poor due to cannibalism. Careful grading of fish before stocking can largely prevent these effects (Kerby et al. 1983b, 1987a).

Stocking densities of 10,000-25,000 fish/acre may result in more uniform size fish and better overall survival (Jenkins et al. 1989). Stocking at densities above 25,000/acre results in a large biomass of fish, which requires more feed, supplemental aeration, water exchange, and close monitoring of water quality and fish health.

Feeds and Feeding

Salmon and trout feeds that are high in protein (35-50%) have been used by most culturists during phase II production (Parker and Geiger 1984). Sinking feeds are used at many hatcheries, although floating feeds are also satisfactory. As the fish grow, size of feed should be increased (Table 9.1).

During the first month, fish are typically fed 15-25% of the initial stocking biomass per day to provide maximum opportunity to become accustomed to the dry feed. Although the percentage is high, the amount of feed is actually low. After the first month, feeding rates are decreased monthly until near harvest when the fish may receive about 3% of the biomass as a daily ration (Table 9.1).

Striped bass and striped bass hybrids feed best just after sunrise and just before sunset. The daily ration should be divided into at least two portions for morning and afternoon feeding. Some culturists feed up to six times per day, as they believe more frequent feeding increases survival and production and reduces the size variation among fish (Atstupenas and Wright 1987; Jenkins et al. 1989).

Table 9.1. Recommended feed sizes and feed rates for various sizes of phase II striped bass and hybrid striped bass.

Fish weight		Total length		Feed size	Feed rate
(g)	(#/lb)	(mm)	(inch)		(% Biomass)
≥0.4	≤1000	30	1.25	#2	25.0
≥0.8	≤500	44	1.75	#3	15.0
≥15	300	51	2.0	#4	10.0
≥9.0	50	90	3.5	3/32"	7.5
≥25	20	127	5.0	1/8"	5.0
≥75	6	192	7.5	5/32"	3.0
≥150	3	238	9.4	3/16"	3.0

Feed can be distributed numerous ways, including by hand, blowers, automatic timer-activated feeders, and demand feeders. Each has advantages. Feeding by hand or blowers makes it possible to visually assess fish health by observing feeding activity. Blowers spread feed over a large area, thereby reducing competition, which can result in more uniform growth. Feed should be applied from at least two sides of the pond when using a blower. Automatic feeders also dispense feed over a large area and can be set to provide feed at more frequent intervals. Demand feeders are fish-activated and can result in good feed utilization, although striped bass and hybrids sometimes do not train well to this type of feeder in ponds.

Each method of feeding also has disadvantages. Feeding by hand is time consuming, especially late in the season when each pond may receive large quantities of feed. Automatic feeders and demand feeders have a tendency to clog and not feed properly without regular maintenance, especially in humid areas. The approach we prefer is to hand feed once each day, and while at the pond, check the feeders to make sure they are working properly. Some hatcheries place only a 1- or 2-day ration in the feeder so that a malfunction can be quickly detected. By using a multiple approach, culturists can get the benefit of each method while avoiding the disadvantages.

The following is an example of a feed rate calculation:

$$(1) \quad N \times ES = EPN$$

$$(2) \quad W_{t_e} \times EPN = W_t$$

$$(3) \quad W_t \times FR (\%) = F/D, \text{ where}$$

N = number of fish stocked

ES = expected survival

EPN = estimated population number

W_{t_e} = average weight of individual fish

W_t = total fish biomass (standing crop) in pond

FR = desired feeding rate (% of fish body weight)

F/D = daily allotment of feed.

The recommended feed rate in Table 9.1 should serve only as a guide. If the fish do not eat all of the feed provided, reduce the amount. If the rate seems low (the fish are continuously hungry and the condition factor is not as high as desired), the amount of feed should be increased.

Feed Conversion

Feed conversion is expressed as the ratio between fish weight gained and the weight of feed fed. For example, if the standing crop of fish increased 500 pounds in weight after receiving 1,500 pounds of feed, the feed conversion would be 3.0 (1,500 ÷ 500). During phase II production in 1988, all state and federal hatcheries rearing striped bass achieved an average feed conversion of 3.86. The federal hatchery system, which produced 80% of the fish, achieved an overall feed conversion of 1.93, while the state hatcheries averaged 5.7. The federal hatcheries calculate feed quantity using a survival estimate of 50%, and standardized feed size and rate tables (Atstupenas and Wright 1987). An incorrect estimation of survival will greatly influence feed conversions.

Kerby et al. (1983b, 1987a) reported phase II and phase III hybrid striped bass conversion rates ranging from 1.5-2.3. In these studies, conversion efficiency appeared to increase as density increased, and all fish were in excellent condition. Work in South Carolina demonstrated that culturists should be able to achieve feed conversion rates for hybrid and striped bass of 3.0 without adversely affecting growth or survival (Jenkins et al. 1989).

Monitoring Growth

Phase II fish should not be sampled more frequently than monthly to monitor growth and make feed adjustments. General conditions should be observed daily while feeding. Sampling is accomplished by seining in the coolest part of the day, and we prefer using a bag seine approximately 80 feet long with 1/4-inch mesh. The sample should be carried in buckets of water and placed in a holding tank with prophylactic medication. Fish will cease feeding for 3-5 days following seining, so it should not be done too often. The seine will stir sediments, injure or stress fish, and contribute to general disease outbreaks. Summer is the worst time to seine. Caution is the rule, and daily observation is better than physical measurements (Drda et al. 1984).

Water in the holding tank should be well aerated, preferably with compressed oxygen. The fish can be slightly anesthetized with 20 ppm of MS-222 (see comments in Chapter 5 on pH shifts using MS-222). A holding cage made of 1/8-inch mesh placed in the tank is helpful for retrieving the fish. If the fish are to be measured, they should be transferred to an anesthetic bath containing 100 ppm of MS-222. They can be individually weighed and measured to determine uniformity of growth, but composite weights are satisfactory for estimating mean size to adjust feeding rates. Fish can also be weighed on the pond bank. After average size and weight have been determined, new feed size and rates should be established (Table 9.1).

If the fish have not grown as expected, it could be the result of several factors: (1) fish are not adequately trained to eat the dry food; (2) water quality is not satisfactory and fish are stressed; (3) the sample may be biased; another sample should be taken to confirm results of the first; (4) density of fish may be different from that estimated; (5) there may be parasite or disease infections.

If the fish are not eating artificial food, it should be apparent. Increased feeding frequency and rate may encourage fish to begin taking the artificial diet. Use of floating feed allows better evaluation of feeding activity as it allows better observation.

Poor water quality can adversely affect fish growth. If DO is chronically low, the fish will feed poorly. Aeration or water exchange can correct this problem. Excessively high or low temperatures will also cause a reduction in feeding and growth.

Growth and Survival

The average culture period for phase II fingerlings in the southeast is 153 days because culturists do not recommend harvesting until the water temperature is less than 61°F. During this period, phase II striped bass grow to an average size of 40 g and 6 inches; however, this does not represent the maximum size that striped bass can attain during the grow-out period. Research in South Carolina (T. I. J. Smith and W. E. Jenkins, unpublished data) has shown that striped bass stocked at densities of 25,000 fish/acre grew to a size of 4.7 fish per pound (96 g) in 150 days under semi-intensive management conditions (Figure 9.3). Similarly, striped bass hybrids stocked at 6,600 and 15,000/acre have been grown to a mean size of 2.6 fish per pound

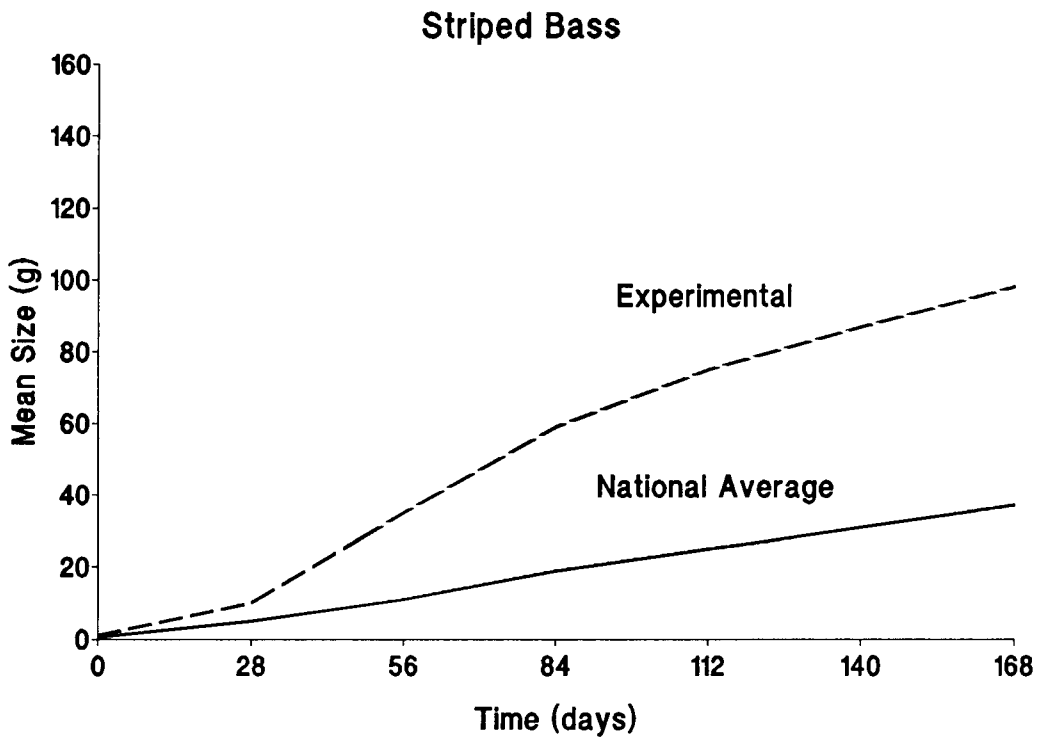
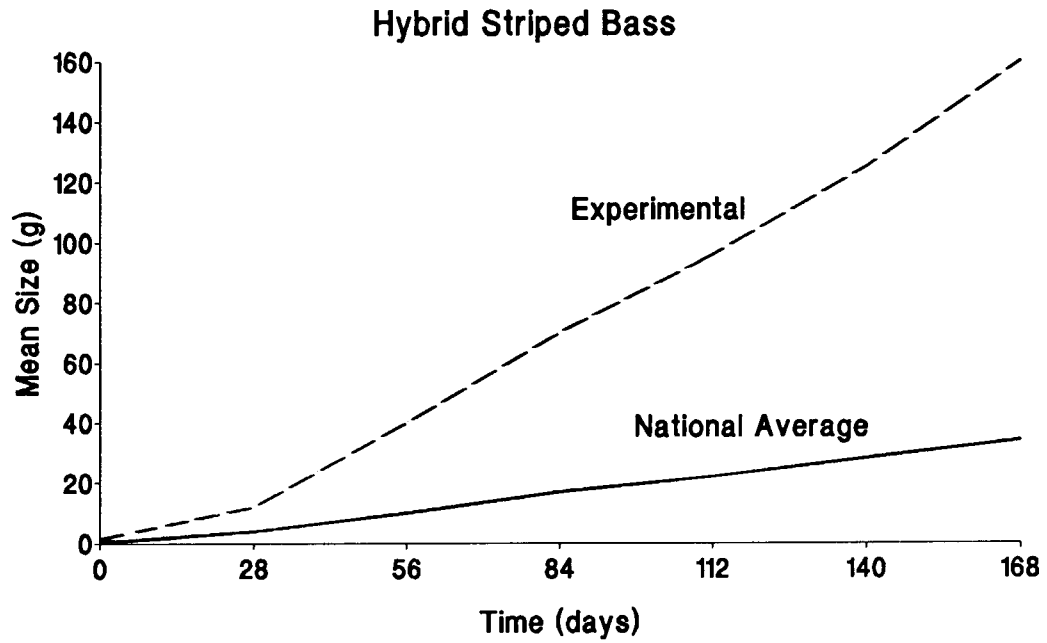

Figure 9.3. Growth of striped bass and hybrid striped bass reared under experimental conditions in South Carolina and under normal nursery conditions.

(170 g) rather than the 18.9 fish per pound (24 g) average achieved at state and federal hatcheries in 1988 (Kerby et al. 1987a; Jenkins et al. 1989).

Water Quality Sampling and Management

The success of phase II culture depends on the culturist's ability to practice good pond management techniques. Water quality characteristics which should be regularly monitored include: DO, pH, ammonia, temperature, carbon dioxide, and phytoplankton density.

Dissolved oxygen. Dissolved oxygen should be measured daily at or before daylight in the deep end of the pond at both the surface and bottom. Oxygen concentration is typically lowest at this time because plants respire during the night, so oxygen is consumed, not produced. After sunrise, photosynthesis and oxygen production begin. Regular monitoring of oxygen concentrations will alert the culturist to imminent problems. For example, if there is a large difference in DO between the surface and bottom, it could indicate that the pond is stratified (there is no mixing between the surface and bottom water). If this condition persists, DO in the bottom water will become depleted, and this area will be unsuitable for fish. This layer will also become a nutrient trap, as ammonia and other metabolites increase when no oxygen is present to nitrify the ammonia. The pond water should be mixed by aerating or pumping to alleviate this problem. If fresh water is added, the water removed from the pond should be drawn from the bottom. If neither management strategy is implemented, a potentially catastrophic situation may occur, commonly called "turning over" or "flipping." This can happen when a rain storm displaces the bottom water and mixes the pond. The phenomenon can also occur when a constant wind from one general direction causes a circulation pattern in the pond which mixes the stratified water (Boyd 1979; Jensen and Bankston 1988).

Dissolved oxygen concentration is temperature dependent, with saturation levels decreasing as temperature increases. Warmer water normally contains less oxygen, while colder water contains more oxygen, so most oxygen problems occur during the warmer months of the year (June through September). During these months, oxygen levels should be measured and recorded daily at daybreak and dusk so that trends in DO can be evaluated. According to Jensen and Bankston (1988), a simple method for detecting when changes in DO may become critical involves comparing daily oxygen readings. For example, if the DO in a pond is ≥ 5 ppm at daybreak and the dusk oxygen level is equal to, or higher than it was the afternoon before, then no oxygen depletion is expected. However, if DO at daybreak is ≤ 5 ppm and at dusk it is less than it was the day before, oxygen depletion is likely to occur that night and aeration or water exchange should be implemented (Figure 9.4).

Another method for determining when oxygen depletion may occur involves measuring DO at sunset and again at midnight. The rate of decrease in DO concentrations during this time can be used to estimate how low oxygen levels will get by sunrise (Figure 9.4) (Jensen and Bankston 1988). If a DO concentration less than 3 is predicted, aeration or water exchange should be implemented. Water entering the pond should be broken-up into as small droplets as possible, either through an aeration tower or an alfalfa valve which breaks up the normal

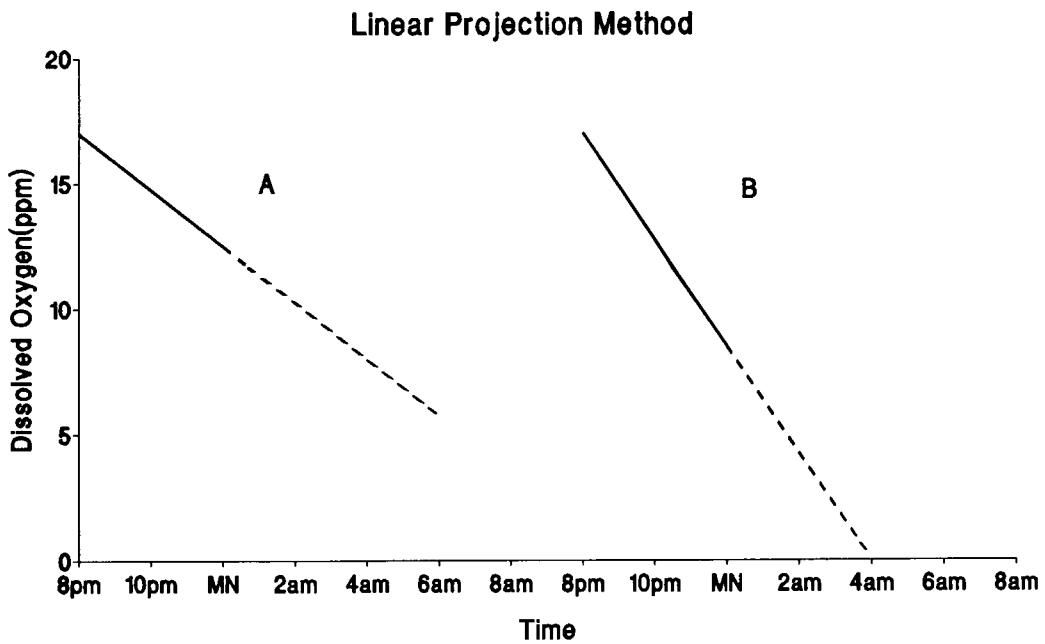
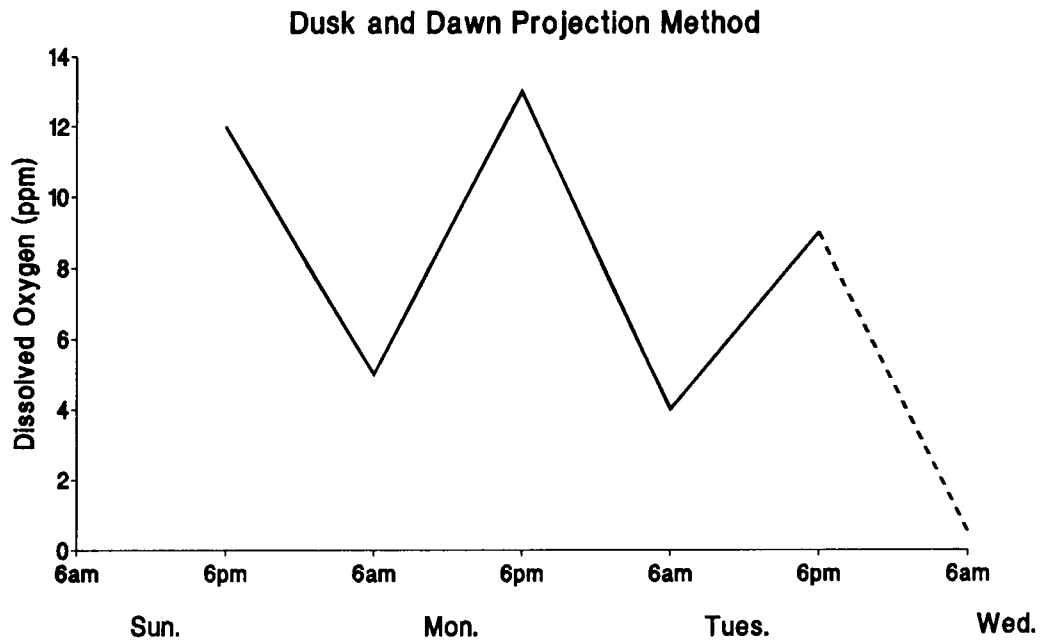

Figure 9.4. Two methods for predicting the occurrence of potentially lethal night-time oxygen levels.

flow. *Remember, well water contains little or no oxygen.* The preferred oxygen level for phase II culture is >5 ppm throughout the water column (Kerby et al. 1983b). If DO is less than 3.0 ppm, do not feed the fish because they will probably not feed well and uneaten food will add to the DO problem.

Pond temperatures should be measured daily at the surface and bottom to detect stratification. Differences between the surface and bottom should not exceed about 5°F. Temperature is also important for evaluating feeding response and growth of juveniles. Feeding activity will decrease at temperatures below 60° and above 90°F. When these temperatures occur, feeding rates must be adjusted to avoid overfeeding.

pH. Acidity (pH) of water, should be measured at least once each week. It is best to maintain values between 6.5 and 9.5 because fish growth is inhibited at levels outside this range, and a pH of 4.0 is lethal for many species (Boyd 1979). The pH will be lowest in the morning (due to the formation of carbonic acid during plant respiration) and highest in mid-afternoon, so it is advisable to check both morning and afternoon levels. If pH values are outside the desired range, they can be manipulated by the addition of certain chemicals, such as gypsum or lime (Boyd 1979). Alternatively, pond water can be exchanged with more suitable water.

Ammonia. Un-ionized ammonia (NH_3) is extremely toxic to fish, and the concentration of un-ionized ammonia varies with pH and water temperature. As pH and temperature increase, the ratio of un-ionized ammonia to total ammonia also increases (Table 9.2). The only way to reduce toxicity is to reduce temperature, pH, or ammonia. In a pond, changing the temperature is difficult, but pH can be lowered by addition of chemicals. This may cause additional problems and can be expensive. The best way to reduce un-ionized ammonia is to reduce total ammonia by decreasing the amount of feed and by exchanging pond water.

Table 9.2. Percentage un-ionized ammonia in solution at different pH and temperature values.

pH	Temperature °C				
	16	20	24	28	32
7.0	0.30	0.52	0.70	0.95	0.95
8.0	2.88	3.83	4.99	6.55	8.77
9.0	22.87	28.47	34.42	41.23	49.02
10.0	74.78	79.92	84.00	87.52	90.58

Carbon dioxide. Carbon dioxide (CO₂) is a product of respiration and should be monitored at least weekly; it is highest at sunrise and decreases during the day. Because CO₂ interferes with respiration, the minimum DO concentration required by fish will increase with increasing CO₂ levels; thus, oxygen levels which would normally be satisfactory may be insufficient when CO₂ levels are elevated (Boyd 1979). Levels above about 5 ppm are cause for concern (Boyd 1979), and can be reduced by aeration. In addition, well water low in oxygen may have very high levels of CO₂, rendering it unsuitable for direct pond use without aeration before use.

Phytoplankton. Phytoplankton produces oxygen in the daytime via photosynthesis, but at night and during overcast days, algal respiration competes with the fish for oxygen. If several cloudy days occur consecutively, the algal population may begin to die, causing other water quality characteristics to fluctuate. For example, DO and pH will decrease, whereas CO₂ levels and light penetration will increase. If this occurs, continuous aeration should be provided to maintain oxygen concentrations at satisfactory levels. If the phytoplankton population decreases to the point that light can reach the shallow bottom areas, rooted aquatic vegetation may begin to grow. The presence of this vegetation can inhibit sampling and harvesting, and harbor predators. It may also interfere with feeding or reduce suitable pond habitat.

Optimal phytoplankton density will allow light to penetrate from 16-30 inches (Boyd 1979), and can be monitored with a Secchi disk. Light penetration measurements should be taken when the sun is directly overhead, and if the visibility level is less than 16 inches, aeration or water exchange may be required. If the depth of penetration increases beyond 30 inches, inorganic fertilizers can be added to increase phytoplankton production. If rooted vegetation has begun to develop, do not fertilize because the rooted plants will begin to grow rapidly.

Aeration. Use of aeration equipment (Chapter 12) will make successful culture of phase II fish much easier to achieve. Each pond should be supplied with an aerator. Paddle wheel aerators provide a high transfer of oxygen per unit of horsepower, but there are many other suitable methods of aeration (see Chapter 12). Providing aeration each night from June through September will alleviate much of the concern about morning DO levels, but must be weighed against economic output. Installation of automatic timers to activate aerators each night and turn them off at dawn will reduce wear on the equipment and the pond manager.

In conclusion, water exchange and aeration are the most effective tools for controlling water quality in phase II culture ponds. Inflowing water should be tested to verify that it is better than the water it is replacing. Spraying or splashing the incoming water is recommended. It does little good to add water low in oxygen and high in CO₂ to a system that already has problems.

Predators and Competitors

There are numerous predators which can adversely impact phase II production. Some groups can be easily controlled by proper management, while others are almost impossible to

control. These predators can be divided into the major vertebrate groups: fishes, reptiles, birds, and mammals.

Fish. Accidental introduction of fish may cause competition and predation. This may result in reduced growth and survival. Some culturists have intentionally stocked weed eating fish, such as *Tilapia* spp., in ponds to control aquatic vegetation (Minton 1985). However, after exhausting preferred vegetation, these fish will eat feed intended for the striped bass.

Reptiles. Water snakes and alligators are the most noticeable reptile predators, although snapping and soft shell turtles can cause minor problems. Snakes and turtles should be removed as quickly as possible. Alligators should be live-trapped and relocated to a more suitable area as far from the hatchery as possible, because large specimens have been shown to exhibit strong homing instincts. Alligators not only eat fish, they will also eat fish food, and fish will avoid feeding areas while alligators are present (Drda et al. 1984). They also make it difficult to find volunteers to seine the ponds.

Birds. Birds can be a problem once they discover that the ponds offer an easy source of food. Wading birds are significant predators, particularly in ponds with areas less than 3 feet deep. If the pond is designed with a minimum area of shallow water, predation by wading birds will be substantially reduced.

There are also numerous predatory diving birds, many of which are migratory, that represent a significant problem in the southeast during the winter months. Harvesting phase II fish in October or early November will reduce predation associated with these birds.

Birds such as ospreys, belted kingfishers, and terns also prey on phase II fish. Ospreys prefer larger fish and probably will concentrate on phase III grow-out ponds, so they are seldom a significant problem in phase II culture. Predation can be reduced by using a sinking feed, which results in the fish being less surface oriented and less vulnerable to airborne predators.

Mammals. Otters, minks, and other small mammals should be controlled quickly. Trapping is effective, as is installation of electric fences around the ponds. Two wire strands (approximately 6 inches apart) will be effective, especially if the animal is wet. Man is probably the most efficient predator; however, he is usually more interested in larger fish. Regular patrols and lights on the pond will help discourage predation by man.

If management techniques, such as proper pond design, harvesting before migrant birds arrive, screening inflow waters, and installation of lights and electric fences do not reduce predation, alternative measures may be required. Numerous devices are available for discouraging predation. The worst case scenario may require covering the entire pond with plastic webbing, but even that can be cost-effective (Drda and Knox 1982). (Other strategies designed for controlling birds are covered in Chapter 8.)

Diseases

Numerous diseases and parasites have been reported (Hawke 1976; Kerby et al. 1983a; Mitchell 1984; Parker and Geiger 1984; Hawke and Minton 1985; Atstupenas and Wright 1987), many of which are explained in Chapter 13. Daily observations of feeding activity, color, and alertness of the fish will allow detection of an impending disease before it becomes serious. If fish start feeding poorly, and it is not a response triggered by water quality or temperature change, some type of infection or parasite may be the cause. Fish are more susceptible to disease when they are stressed (see Chapters 12 and 13). Maintenance of good water quality will greatly reduce the incidence of diseases.

Vegetation

Undesirable aquatic plants can become established in phase II culture ponds. Pond depths of at least 3 feet and maintenance of phytoplankton blooms will reduce the incidence of aquatic weed infestations, which limit habitat and can interfere with harvesting and feeding. (Measures for control of aquatic vegetation are found in Chapter 8.)

Harvest

Harvest can be conducted at temperatures between 40 and 60°F. If temperatures are higher, mortality due to handling stress may be high. At lower temperatures, fish are sluggish and may not move with the water to the catch basin as the pond is drained. When the pond is 1/2 to 1/3 empty, internal kettles should be cleaned of any mud or debris that has accumulated during the grow-out period (Atstupenas and Wright 1987). At harvest, the pond is drained slowly, allowing fish to move to the kettle. If available, the kettle should be supplied with clear, highly oxygenated water. Fish should be seined using the same technique described for phase I fish (see Chapter 8). Group weights of fish should be taken and the number of fish estimated immediately before loading onto the hauling trucks.

If the pond does not have a kettle, seining should begin when the water is still at least 2 feet deep in the deep end, which is enough depth to concentrate the fish. Once the fish are captured in the seine, the bag should be moved back and forth to wash off any mud. If there is water inflow at the drain, they should be rinsed. The fish are then dipped from the seine into buckets containing water. On cold, windy days, ice can form on the gills of exposed fish in the time it takes to remove them from nets and place them in a hauling tank.

Seining should continue until most of the fish have been captured; then draining can be completed. Continue seining as the pond drains.

Production of Phase III Fish

Pond production of subadult and adult (phase III) striped bass and hybrid striped bass involves rearing the fish to market size as food fish or to adults suitable for use as brood stock. This final rearing phase is practiced primarily by commercial aquaculture operations or by research facilities. State and federal hatcheries focus primarily on production of phase I and II juveniles.

At present, information on phase III production techniques in ponds is mostly limited to research trials, as the commercial industry is just beginning. However, the Edenton National Fish Hatchery (U.S. Fish and Wildlife Service) and North Carolina State University have been developing techniques for rearing striped bass brood stock and hybrids for commercial culture in ponds since the late 1970s. The South Carolina Wildlife and Marine Resources Department has been actively developing such techniques in commercial size ponds (1.25 acre) for about five years. Techniques and production results should be similar to those which will be achieved by the commercial industry in the next several years, assuming availability of sufficient water, seed stock, and aeration. Many of the management techniques previously described for phase II production are applicable to phase III production.

Pond Design and Preparation

In general, phase III pond production will be conducted under semi-intensive conditions to make it economically feasible. Pond design can vary from square to various rectangular configurations; we expect that large cylindrical ponds with center drains, or wedge-shaped ponds which share harvest structures will also be utilized. Pond size will vary, ranging from about 1 to 5 acres and it is important that pond size be such that good management control can be maintained. Pond preparation will be similar to that described for phase II production and, in many cases, the same ponds will be used.

Stocking Techniques and Densities

Phase II juveniles to be stocked for phase III grow-out will range in size from about 4.5-2 fish per pound (100-225 g). Numbers of fish should be estimated based on sample weights. Preferred stocking time is during the winter or early spring, when water temperatures are low. Before stocking, fish should be properly acclimated to pond conditions, and ponds should be inspected for post-stocking mortalities, which should be insignificant (<0.5%) if proper procedures are used.

Stocking density is a function of a number of factors, including pond size and design, harvest strategies, harvest size, feeding rates, water resources, availability of electricity to operate aeration equipment, and certain investment and risk considerations. Based on current technology, stocking densities range from about 2,000-6,000 fish/acre for final grow-out. *At these levels, semi-intensive management techniques must be practiced.*

General Culture Techniques

Crop success will largely be determined by the farmer's ability to practice sound management techniques. Maintenance of high water quality is essential. Techniques described for phase II culture are applicable for further grow-out; however, due to increased biomass typical in phase III production, constant vigilance is required to keep oxygen levels and other water quality characteristics within acceptable limits. Oxygenation equipment (see Chapter 12) should be regularly utilized, especially during the warmer months (June through September), and intermittent or continuous water exchange may be necessary.

A quality feed should be provided at least daily during the growing season. Feed type can be sinking or floating, and feed size should be adjusted according to fish size. A 38% protein sinking trout feed has been used successfully in South Carolina experiments. It was provided at least twice daily at a rate equal to about 1.7-2.1% of the estimated biomass during the growing season. Estimated biomass is based on weight data obtained from regular seine samples and estimated survival rates (80-95% under proper conditions). Culturists should be aware that fish tend to school by size in a pond, and as fish size increases, it becomes increasingly difficult to obtain representative samples. Careful grading of phase II fingerlings before stocking for phase III grow-out can reduce growth and size variability.

Due to the concentration of fish, phase III ponds can be quite attractive to predators. In particular, birds, mammals, and in more southerly regions, reptiles (such as snakes and alligators) may regularly visit the pond. The culturist should practice scare tactics and other legal methods to discourage potential predators. Proper security must be provided to protect the farmer's investment from human predators as well.

Depending on the marketing approach, pond size, production levels, and other factors, fish can be partially harvested by seining, or the pond can be drained and the fish mechanically or manually removed. At harvest, a sample of fish should be measured to obtain information on size distribution and survival. Fish should be handled gently and placed in ice water immediately after harvest. This will preserve their quality and minimize bruising, which results in discoloration of the product.

Semi-Intensive Production Trials

A number of semi-intensive production trials have been conducted in North Carolina (Kerby et al. 1983b, 1987a; Huish et al. 1987) and in South Carolina at the Waddell Mariculture Center (Smith 1989; Smith et al. 1989) to culture hybrid striped bass for food fish. In the North Carolina studies, stocking densities ranged from 4,000-6,000 fish/acre, and survival normally exceeded 80%. Standing crops at harvest ranged between 1,859 and 5,084 pounds per acre. Average weight at harvest ranged from 0.8-1.5 pounds, and average feed conversions ranged from 1.1-2.3. In the South Carolina studies, stocking densities ranged from 2,700-4,800 fish/acre, with phase II fingerlings averaging 1.8 fish per pound (242 g) (Table 9.3). After 10-12 months of culture, fish averaged 1.9 pounds (862 g), with survival ranging from 93-96%. Production levels were related to stocking density, with 8,655 pounds per acre produced at the highest density (Table 9.3). Feed conversion using a commercial trout ration was 2.2-2.3. These studies demonstrate that hybrid striped bass can be produced under high density conditions in ponds managed semi-intensively.

Production of Phase III Striped Bass Brood Stock

Little published information exists on pond production of subadult and adult striped bass, although the Edenton National Fish hatchery has practiced this culture since the 1970s, and at one time maintained (and spawned) cultured brood stock from five different Atlantic strains (Kerby 1986). Wawronowicz and Lewis (1979) reported 91.8% survival and a standing

Table 9.3. Stocking and harvest data for hybrid striped bass in pond grow-out trials (phase III) at Waddell Mariculture Center.

Type of hybrid	Stocking		Study duration (days)	Harvest			
	Density (No./ha)	Mean weight (g)		Mean weight (g)	Survival (%)	Standing crop (kg/ha)	Feed conversion
Palmetto	12,000	220	229 ^a	755	92.9	8,323	2.3
Sunshine	10,000	203	251 ^a	857	93.1	7,910	2.2
Sunshine	12,000	272	370	863	93.7	9,699	2.3
Sunshine	6,800	272	344	972	96.2	6,308	2.2

^aTime to first partial harvest. Fish did not grow after this time.

crop of almost 900 pounds per acre in an Illinois pond. However, as aquaculture interest increases, there will be substantial efforts to culture brood stock in earthen ponds.

In South Carolina, there are limited data on culture of striped bass in a brackish water (4-6 ppt salinity) pond at a low density. Phase II fingerlings produced from cultured brood stock were used (Smith and Jenkins 1988a); they were harvested from a pond on January 27, 1988, and placed in a fiberglass raceway which received continuously flowing water. The fish were reared in the raceway until June 21, 1988, when they were stocked in a pond at a density of 940 fish/acre. At harvest on March 13, 1989, survival was 83%. After ripe males were removed for hatchery use, fish were re-stocked and cultured until July 10, 1989, when their mean weight was 3.2 pounds (Table 9.4). Thus, subadult and adult striped bass were produced in ponds, and ripe males were produced in about 24 months under conditions typical of ponds in the southeastern U.S.

Table 9.4. Growth and survival of pond-reared striped bass in South Carolina.

Date	Days (No.)	Stocking density (No./hectare)	Mean size (g)	Comment
01/27/88			97	Stocked in tanks
06/21/88	1	2,322	383	Stocked in ponds
08/05/88	45		569	Pond-reared
09/02/88	73		614	Pond-reared
10/27/88	128		1,008	Pond-reared
03/13/89	264	1,934	1,014	No growth Nov-Feb
04/13/89	295		1,151	Pond-reared
07/10/89	383		1,432	Pond-reared

Intensive Culture Techniques for the Striped Bass and Its Hybrids

Larry C. Nicholson, L. Curry Woods III, and John G. Woiwode

The culture of striped bass (*M. saxatilis*) in intensive systems has been accomplished with some degree of success for almost as long as the species has been cultured in ponds. Although considerable progress has been made in developing techniques for intensive culture of striped bass and *Morone* hybrids over the last two decades, much more information must be obtained to solve remaining problems. When *Guidelines for Striped Bass Culture* was first published in 1976, it was stated that intensive culture techniques for striped bass were still in the developmental stage (Bonn et al. 1976). Over a decade later, new techniques are still being developed, and striped bass and hybrid intensive culture will continue to evolve in the foreseeable future.

Historically, striped bass and (later) hybrid striped bass were noted as fish with potential for intensive culture (Anderson 1966; Williams et al. 1981; Kerby et al. 1983a). Both exhibited rapid growth, and could be trained to accept artificial feeds under controlled conditions. They also tolerated a relatively wide range of water quality conditions. These factors, plus their wide acceptance in recreational fisheries and high market value, continue to generate interest for culturists.

After Stevens (1966) developed a method to artificially spawn striped bass using human chorionic gonadotropin, intensive culture of *Morone* began to develop. Initially, eggs were incubated in MacDonald hatching jars. After hatch, fry were maintained in aquaria or troughs for 4-5 days (depending on water temperature) while their digestive systems developed. Most early intensive efforts were directed toward holding fry before they were stocked into rearing ponds in an effort to enhance survival. The fry were fed brine shrimp (*Artemia* spp.) nauplii during the holding period. (See Chapters 5 and 8 for more details on holding and feeding fry.)

Bayless (1972) refined fry-rearing techniques at the Moncks Corner, South Carolina, Striped Bass Hatchery. Fry were grown in 80-gallon marine epoxy-coated wooden troughs for a period of 7-15 days post-hatch. They were initially fed brine shrimp nauplii and later offered starter mash and ground fish at a rate equivalent to 10% of their body weight per day. This rearing technique allowed culturists to control and observe the critical period of initial feeding.

They found that this procedure frequently increased subsequent survival of striped bass transferred to rearing ponds.

In an effort to enhance survival, culturists in Oklahoma placed larvae in floating saran-covered cages in tanks and ponds for 5 days post-hatch. The cages were then submerged and the fish were allowed to escape. Inslee (1979), in a 3-year study of the cage-culture technique, demonstrated an approximate increase of 50% in survival of cage-held fry over fry held in aquaria and subsequently stocked in ponds. (See Chapter 8 for details.)

Experiments were conducted in the early 1960s to intensively culture fingerling striped bass at the North Carolina State Fish Hatchery at Weldon, North Carolina. Two-day-old larvae were stocked in 700 cubic feet concrete ponds at densities of 1.9 and 9.5 per gallon. Fry were maintained on live zooplankton for 3 weeks and trout starter meal thereafter. Fingerlings ranged from 2.4- 5.1 inches at the end of 16 weeks, with a survival rate of 85% (Tatum et al. 1966).

Numerous other government and private hatcheries, universities, and other organizations have endeavored to intensively rear striped bass or hybrids. These organizations have helped advance the techniques and methods used today, but rearing *Morone* intensively is still far from an exact science. Basic information that is still lacking for the first three months of growth includes, but is not limited to: (1) nutritional requirements, (2) methods to prevent cannibalism, (3) a more complete understanding of the physiology of swim bladder inflation, (4) ways to better control and treat infectious diseases, and (5) better handling techniques.

Holding Facilities

Aquaria are still often used as initial holding tanks (Allen 1974), with fry generally stocked at densities of approximately 3,800/gallon. They can remain in aquaria for 5-10 days post-hatch before transfer to larger facilities, usually earthen ponds or circular culture tanks. Food, in the form of live brine shrimp nauplii, is introduced 4-5 days post-hatch. When the fish are feeding satisfactorily, they are transferred to the principal culture facilities. If fry are to remain in aquaria for more than 10 days, their density must be decreased. Holding fish in aquaria beyond this age at this density may adversely affect growth and survival (Allen 1974), because cannibalism, adequate food, and acceptable water quality become increasingly difficult to control or maintain with higher stocking rates.

Aquaria have several advantages for short-term holding of larval and post-larval fish. The fish are accessible, observable, and can be manipulated. Food can be concentrated to insure high probability of contact with fry. Because aquaria are normally placed in a laboratory, temperature, salinity, and photoperiod can be controlled. For extended culture periods, however, aquaria have proven unsatisfactory because the rectangular configuration of standard aquaria is not conducive to efficient water circulation, and the corners become catchment areas for solids (Huet 1972).

Circular tanks are a considerable improvement over aquaria for long-term *Morone* culture; size and shape are their two major assets. These tanks are constructed of various materials: fiberglass, metal, concrete, concrete block, rigid plastic, and flexible vinyl (Woods et al. 1981, 1985a). Most commercial operations use circular tanks constructed of fiberglass or concrete. Capacity depends on use (i.e., nursery or production), and typically ranges from 55 gallons to over 10,500 gallons. A variety of sizes are readily available with 6-foot and 20-foot diameters being the most common (see Appendix B for vendors). Circular fiberglass tanks are currently the most widely used for phase I production. This configuration contributes to good water circulation without dead zone areas. After fish are large enough to maintain position in the current, water velocity and tank turnover rate can be increased to remove sediments and wastes, thereby minimizing tank maintenance. One disadvantage of circular tanks is that they do not conform to efficient use of space as readily as rectangular tanks. The single-pass open system used at the Crane Aquaculture Facility, Baltimore, Maryland, and a schematic of the recirculating system used at the Gulf Coast Research Laboratory, Ocean Springs, Mississippi, are presented in Figures 10.1 and 10.2.

Rectangular (raceway) tanks are second only to circular tanks in the number being used to intensively culture *Morone*. Like circular tanks, they can be constructed from numerous materials, including metal, fiberglass, concrete, concrete block, plastic, and vinyl. Water replacement is efficient, with newly introduced water forming a simple laminar flow through the tank to the discharge. As fry grow and become more proficient swimmers, cleaning can be facilitated by increasing flow rate. Rectangular tanks have two primary disadvantages: the corners have a tendency to accumulate solids, and the shape does not offer fish a continuous, uninterrupted swim path.

Cages, net-pens, baskets of netting, and screen or wire have been used for many years as fish containers. They can be of various shapes, from square to cylindrical, and constructed of numerous different mesh sizes, depending on the size of fish being cultured. For culture of fry to phase I fingerlings, the frame is covered by webbing with a mesh opening of 500 μm for striped bass and hybrids made with female striped bass, and 250 μm for hybrids made with females of white perch (*M. americana*) and white bass (*M. chrysops*). The larger mesh will allow water and a few smaller food organisms to pass through, while containing the fry. Food availability may be a problem with the smaller mesh; however, by placing the cages in a pond and pumping plankton-rich water into the cage, the fish have access to a continuous food supply.

Whether cage culture is for fry to fingerling, or fingerling to adult, water flowing through the containers helps remove metabolic wastes and provides oxygenated water. Confinement permits easy observation of feeding and growth, processes which are often difficult to ascertain in ponds and large tanks. Another asset of cage culture is the ease with which the fish can be treated for diseases; if necessary, a plastic bag can often be placed around the container and a bath treatment administered without removing the fish from the water. Harvesting is greatly facilitated, and minimal handling is required. Containers can be lifted and the fish



Figure 10.1. Single-pass culture tanks used at the Crane Aquaculture Facility. Photo Credit: Baltimore Gas and Electric Company.

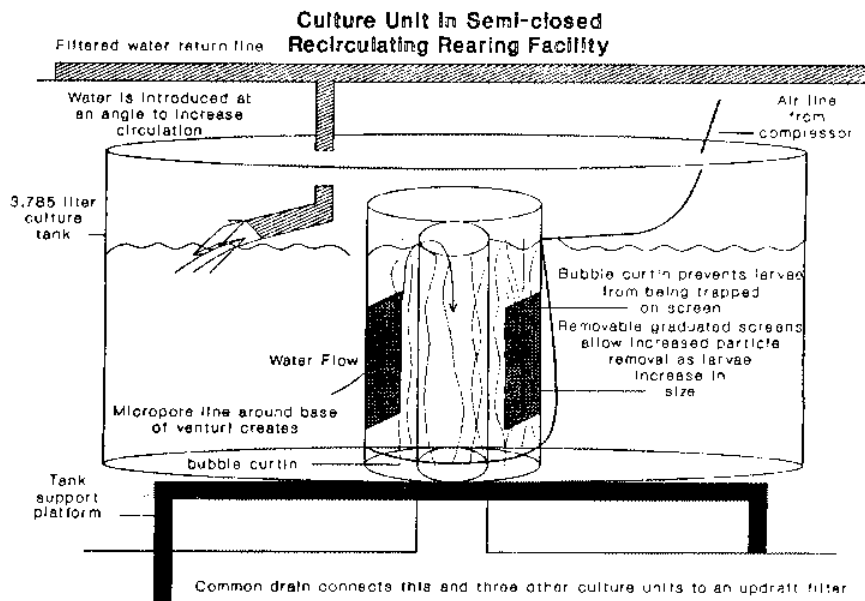

Figure 10.2. Schematic of the recirculating system used at the Gulf Coast Research Laboratory. Schematic by J. Y. Christmas.

removed as needed, or, in the case of fry, the cage or basket can be opened and the fish allowed to escape without being netted (Inslee 1979).

Culturists in Alabama, South Carolina, and North Carolina demonstrated the feasibility of cage culture in brackish water for production of advanced fingerlings or subadults (Powell 1973a,b; Williams et al. 1981; Woods et al. 1983). However, Williams et al. (1981) noted bacterial disease was a limiting factor for striped bass cage culture in marine environments. Other limiting factors must be considered as well. The cultured fish may be subject to adverse ambient conditions and they cannot move to areas of more favorable water quality. The cage or pen may become so completely encrusted with fouling organisms or algae that water cannot be adequately exchanged. At higher stocking densities, physical abrasions may occur from contact with the cage or net pen.

Harrell et al. (1988) reported that striped bass and hybrids could overwinter in cages under ice for a considerable period of time. However, if the water temperature drops too fast, the natural processes that normally break down metabolic wastes could be disrupted, resulting in high ammonia levels (R. M. Harrell, University of Maryland, personal communication).

Filters

Filters are an essential part of closed or semi-closed intensive culture systems that are increasingly used in the culture of striped and hybrid striped bass larvae through adults. Filters can be divided into two major categories, biological and mechanical. Mechanical filtration involves physical removal of suspended solids, detrimental organisms, and other particulate matter. Biological filtration was defined by Spotte (1979) as the mineralization, nitrification, and dissimilation of nitrogenous compounds by bacteria suspended in the water and attached to the filter media.

Mechanical filtration efficiency is primarily determined by the particle size of the filter medium; efficiency increases as particle size decreases. Smaller filter particles also have small interstitial spaces, which enhance entrapment of finer particulate matter. The shape of the filter media is also important. Rough materials with irregular surfaces are more efficient than smooth, uniform, media.

Sand filters are the most common type of mechanical filters. Surface area is not as critical in these filters as it is in other types of mechanical filters, because flow rates are high and removal of particulate matter occurs throughout the filter bed, rather than just at the surface. Sand filters can be divided into two types — pressure and non-pressure. Non-pressure filters are generally large, and not totally enclosed. Pressure sand filters, or rapid sand filters, are enclosed filters containing a sand medium, through which water is pumped. Rapid sand filters can function both as mechanical and biological filters because the interstitial spaces in the sand medium are large enough to allow nitrifying bacteria to establish and flourish. Pressure sand filters can be equipped with automatic valves to control filtration and backwash cycles.

Diatomaceous earth, another type of filter medium, is composed of skeletal remains of diatoms. Diatomaceous earth is held against a permeable membrane by vacuum or water pressure. These filters can remove particulate matter as small as 0.1 μm (Spotte 1979). Because the interstitial spaces are so small, diatomaceous filters serve only as mechanical filters.

Diatomaceous earth filters provide very clear water, but they clog easily, require regular maintenance, and are expensive to operate. When used continuously, the filter cake must be discarded at the end of each filter cycle and replaced. By connecting the diatomaceous earth filter in series after a rapid sand filter, the load on the diatomaceous earth filter is minimized, extending the life of the filter cake.

Biological filtration is the process by which soluble, often toxic, nitrogenous compounds excreted by the cultured organism are broken down by autotrophic and heterotrophic bacteria to non-toxic forms. In the process of nitrification, ammonia is converted to nitrite (NO_2 , calculated as $\text{NO}_2\text{-N}$) by *Nitrosomonas* spp. and then converted to nitrate (NO_3 , calculated as $\text{NO}_3\text{-N}$) by *Nitrobacter* spp. (Spotte 1979). These autotrophic bacteria utilize inorganic carbon in the form of CO_2 as a source of energy. A very toxic substance, ammonia, is thus converted to nitrate, which is relatively non-toxic to striped bass.

The efficiency of the autotrophic conversion, and the biological filter as a whole, is determined by six factors: (1) surface area of the filter medium, (2) temperature, (3) pH, (4) dissolved oxygen, (5) salinity, and (6) the presence of bacteriocidal compounds (Spotte 1979). Many beneficial bacteria can survive sudden temperature changes. Srna and Baggaley (1975) found that a 4°C increase in seawater temperature increased ammonia and nitrite oxidation by 50% and 12%, respectively. They also reported a 30% reduction in ammonia conversion with a 1°C drop in temperature, and an 8% drop in nitrite to nitrate oxidation with a 1.5°C decrease in water temperature. Saeki (1958) determined that 7.1-7.8 was the best pH range for biological filtration of fresh water; lower and higher pH inhibited oxidation. In marine and brackish water, a pH of 7.5 is optimum and a range of 7.0-8.2 is satisfactory. Salinity is not as critical to heterotrophic and autotrophic bacteria as pH and temperature, if changes are gradual.

The surface area and exposure of the filter medium determines the amount of space available for attachment of heterotrophic and autotrophic bacteria. For instance, one grain of sand, located in the upper layer of a biological filter, was calculated to accommodate 10 bacteria capable of metabolizing nitrogenous compounds (Kawai et al. 1965). At a depth of 2 inches, the number of bacteria dropped by 90%. Small particles offer more surface area for attachment of bacteria, but very fine particles may restrict water movement through the filter. Saeki (1958) reported that grain size of 2-5 mm was optimum. He also noted that coarse, angular grains presented a larger surface for attachment, compared with smooth, regularly-shaped media.

Fluidized biofilters, composed of sand, crushed coral, or granular carbon that become suspended as water flows through the media can ameliorate the problem of decreasing filter efficiency with depth. The suspended particles expose all surfaces to nutrient laden water, which eliminates clogging and channelization (Paller and Lewis 1988).

Nitrification is responsible for a significant amount of oxygen uptake. Heterotrophic bacteria also consume relatively large quantities of dissolved oxygen in their metabolic processes. Nitrification can take place when dissolved oxygen levels are low; however, organic acids are formed instead of bases. By oxygenating the water before it passes through the biological filter, the culturist is assured that the aerobic nitrifiers will predominate and thrive.

Biological filters should be activated before introducing fish into a closed or semi-closed intensive culture system. This ensures sufficient numbers of heterotrophic and autotrophic bacteria will be available in the filter to handle the nitrogenous load after fish are introduced. Biological filters can be inoculated with water and filter bed material from active or working filters, or *Nitrosomonas* and *Nitrobacter* cultures can be purchased. Nutrients for the nitrifying bacteria, in the form of ammonia sources must be added to the system. Organic sources of ammonia have been used to activate the bacteria of biofilters. Siddall (1974) found $2(\text{NH}_4)\text{SO}_4$ and NH_4CL to be much more efficient than organic sources in supplying the needed ammonia. He used 3.3 ppm of $2(\text{NH}_4)\text{SO}_4$ or 3-6 ppm of NH_4CL . Meade (1974) suggested maintaining an ammonia concentration of 10-20 ppm and a pH of 7.5 during the filter activation period. He also recommended that the water temperature during activation should be maintained about 9-14°F higher than the water temperature of the fish culture system. An activation period of at least two weeks is required to develop sufficient nitrifying bacteria populations in biological filters. During the activation period, levels of ammonia and nitrate should be monitored to ascertain the viability of the bacteria culture.

Activated carbon filters work by physical adsorption, and should follow biological and mechanical filtration in a water-filtering process. Adsorption is the collection of dissolved organic carbon on an appropriate interface. Activated carbon (in powdered or granular form) can remove dissolved organic carbon from culture water. The powder has more surface area, but it is expensive and difficult to handle. Granular carbon (>100 μm) is commonly used by striped and hybrid striped bass culturists. The effectiveness of granular activated carbon in adsorbing dissolved organics depends on: (1) contact time, (2) concentration and type of organic material, and (3) the surface area of the activated carbon (Spotte 1979). When activated carbon filters are used in series with biological and mechanical filters, a very effective filtration system can be achieved.

Water Quality

Survival, growth, and physical condition of the fish are largely a function of the quality of water in which they are cultured. Tolerance to varying conditions (e.g. pH, temperature, and salinity) increases rapidly from post metamorphosis through the first year, then decreases for certain variables with age (Setzler et al. 1980). Fish cultured with optimum water quality grow faster and are best able to withstand stress and disease challenges.

Temperature

Water temperature is one of the most important factors affecting survival and growth of striped bass through all stages of their life cycle. Temperature has a direct effect on metabolism,

as well as indirect effects on the fish as it affects pH, dissolved oxygen, and nitrification. In general, striped bass eggs and larvae can survive temperatures ranging from 54-75°F, but they can be gradually acclimated beyond these extremes. Doroshev (1970) noted total mortality of larvae at temperatures below 50 and above 79°F. Ideally, water temperatures should be maintained between 57 and 70°F until larvae are at least 9 days old. Davies (1970, 1973) enhanced survival of striped bass larvae and fingerlings exposed to extreme temperature conditions by acclimation. Chronic exposure of fingerlings to temperatures between 34 and 43°F in salt water limited growth and decreased survival (Valenti et al. 1976). Fingerlings, juveniles, and adult striped bass in estuarine waters (3-8 ppt) repeatedly survived temperatures as low as 33.8°F (L. C. Woods III, unpublished data).

Preliminary data suggested that a temperature range of 64-90°F was suitable for culturing striped bass and striped bass hybrids (Bonn et al. 1976). Cox and Coutant (1981) reported that zero growth of striped bass juveniles due to cold temperature occurred at approximately 50°F, and due to warm temperature at approximately 92°F. Original hybrid striped bass (palmetto bass [striped bass x white bass, *M. chrysops*]) juveniles are more eurythermic, with zero growth due to cold temperature at 44°F (Woiwode 1989). No upper temperature zero growth point has been established; however, Woiwode and Adelman (1984) reported that 8 g hybrids exposed to 94°F for 30 days grew at a specific growth rate of 2.6% per day.

The optimum temperature for growth of juvenile striped bass, calculated as the peak of Cox and Coutant's (1981) growth model, is 75-77°F, with peak food consumption at approximately the same temperature. Woiwode (1989) reported that the optimum temperature for growth of hybrid striped bass juveniles was 80°F, and peak food consumption was at 82.4°F.

Decreasing the amount of food fed to hybrid striped bass yields a corresponding decrease in the optimum temperature for growth: from 80°F when fed to satiation, to 75°F at 60% satiation, to 70°F at 30% of satiation (Woiwode 1989). Juvenile striped bass, however, did not demonstrate this same response when fed approximately 60 and 30% satiation. Their optimum temperature for growth remained the same (Cox and Coutant 1981).

Striped bass exposed to temperatures with a diel oscillation of $\pm 7.2^\circ\text{F}$ around a mean of 64.4°F exhibited significantly faster growth than striped bass exposed to constant 64.4°F (Cox and Coutant 1981). There was an accompanying shift in the optimum temperature for growth to a cooler temperature. However, even when exposed to diel oscillations as great as $\pm 14.4^\circ\text{F}$ around a mean of 70°F (29°F change every 12 hours), hybrid striped bass had the same growth rate as hybrids exposed to a constant temperature of 70°F (Woiwode 1989).

Coutant (1985b) provided evidence that the optimum temperature for growth of striped bass decreases as the fish age. Plotting growth as a function of latitude, he reported that striped bass grew faster in southern latitudes due to warmer water until age three; thereafter, they grew faster in cooler climates. Hybrid striped bass may also undergo this shift toward cooler optimum growth temperatures. Woiwode and Adelman (1984) reported that the optimum temperature for growth of 8 g hybrids was between 81 and 88°F, but Woiwode (1989) found that the optimum for 130 g hybrids was 80°F.

Cox and Coutant (1981) found that striped bass peak conversion efficiency occurred at approximately the same temperature as the optimum for growth. Woiwode and Adelman (1984), however, indicated that peak conversion efficiency for 8 g hybrids was between 66 and 73°F, which is significantly cooler than their optimum temperature for growth (81-88°F). Woiwode (1989) found that the temperature of 70°F for peak conversion efficiency for 130 g hybrids was significantly less than the reported 80°F optimum growth temperature.

Photoperiod

Growth rate and optimum temperature for growth of hybrid striped bass are significantly influenced by photoperiod. Woiwode (1989) found that, when photoperiod changed at a rate of 4.3 minutes per day for 41 days from a starting point of 12L:12D (12 hours light:12 hours dark for a given 24 hour time frame), 40 g hybrids grew significantly faster under increasing daylength than they grew under decreasing daylength. Additionally, the optimum temperature for growth shifted to a warmer temperature (about 82°F) under increasing daylengths, and to a cooler temperature (about 78°F) under decreasing daylengths. Kerby et al. (1987a) found a similar phenomenon in ponds. Growth of hybrid striped bass was almost static when mean monthly temperature was about 59°F during November, when temperature and daylength were decreasing, but growth increased dramatically in March when the mean monthly temperature was also 59°F, but daylength and temperature were increasing.

Dissolved Oxygen

Dissolved oxygen (DO) is the major limiting factor, and is usually the first detectable limiting factor in intensive production systems. Most culturists agree that 4-5 ppm should be considered the absolute minimum outflow concentration for DO in any culture system. Lewis et al. (1981) recommended that DO concentrations be maintained at 6 ppm or more for striped bass and hybrid larval culture.

The carrying capacity of intensive culture systems is most often predicted by the amount of available oxygen in the culture water. By using pure oxygen (generated by pressure swing absorption or liquid oxygen injection systems), maintaining 100% saturation or supersaturation is possible, and the carrying capacity may be increased (Westers 1976; Westers and Pratt 1977). With supplemental oxygenation, carrying capacities can be increased to the point where some other water quality parameter (e.g., ammonia) becomes the limiting factor.

Metabolic Wastes

Significant changes in water quality result from the metabolic activities of fish. For every 1 pound of feed provided to fish, approximately 0.2 pounds of oxygen are used. Conversely, 0.28 pounds of CO₂ is produced in addition to 0.03 pounds of ammonia and 0.3 pounds of fecal solids (Colt 1986).

Ammonia. Ammonia is the primary nitrogenous metabolite produced by fish. It results from deamination of amino acids. Two forms of ammonia are normally present in intensive culture systems, with the un-ionized form (NH₃) being much more toxic to fish than the ionized form (NH₄⁺). The ratio of un-ionized ammonia to the ionized form depends on temperature

and pH. At 68°F and a pH of 9.4, approximately half of the ammonia present is in the NH_3 form. At the same temperature, nearly all of the ammonia is in the NH_4^+ form at a pH of 7, and in the NH_3 form at a pH of 12 (Boyd 1979; Emerson et al. 1975).

Hazel et al. (1971) reported that the striped bass 96-hour LC_{50} value for total ammonia (ionized and un-ionized ammonia combined) ranged from 1.5-2.8 ppm. They also found that, at concentrations below the LC_{50} levels (but exceeding 0.6 ppm), striped bass and hybrids exhibited reduced feeding, slow growth, club-shaped gill filaments, and decreased resistance to diseases. Therefore, assuming a pH of 7.5, total ammonia levels should be maintained below 0.6 ppm in intensive culture systems (Bonn et al. 1976).

Nitrite. Nitrite (NO_2^-) is the intermediate product of the nitrification of ammonia. This nitrogenous compound is second only to ammonia in toxicity to fish. The NO_2^- form readily combines with hemoglobin and causes methemoglobinemia or "brown blood disease," which reduces the capacity of hemoglobin to transport oxygen. Nitrite levels in intensive culture systems should remain below 2 ppm in order to ensure adequate growth and survival (Spotte 1979).

Nitrate. Nitrate (NO_3^-) is the final nitrogenous compound formed by the nitrification of ammonia, and is the least toxic. Striped bass larvae can tolerate levels as high as 200 ppm, whereas juveniles and adults can withstand levels higher than 800 ppm (Kerby et al. 1983b). However, feeding and subsequent growth are enhanced when nitrate does not exceed 38 ppm (Bonn et al. 1976).

Carbon dioxide. Carbon dioxide (CO_2) is a by-product of metabolism. When CO_2 is released into the water, it can combine with water to form carbonic acid (H_2CO_3). This chemical reaction increases the hydrogen ion concentration and consequently lowers the pH. Because the amount of free CO_2 in water is a function of pH, CO_2 concentrations increase as the pH decreases. Increased CO_2 levels in the blood decrease the affinity and carrying capacity of hemoglobin for oxygen. Additionally, CO_2 concentrations in the water can cause a partial pressure differential between the water and blood less than that required to off load the CO_2 into the environment, suffocating the fish even in the presence of DO at or near saturation (Spotte 1979). Some free CO_2 can be removed from culture water by agitation of the surface, which exposes a greater percentage of the water to the atmosphere and reduces the partial pressure. Air-lift pumps are also an efficient means of agitating the surface water to expose more water to the air (Spotte 1979).

Salinity

Striped bass and *Morone* hybrids can be cultured in fresh water, but numerous studies (Barwick 1974; Lal et al. 1977; Van Olst et al. 1980) demonstrated that slightly saline water (i.e., above 1.5 and below 14 ppt) augmented growth and survival. Survival of striped bass eggs and larvae was increased by culturing them in water with approximately 1.7 ppt salinity (Albrecht 1964). Bayless (1972) exposed 48-hour-old larvae to various salinities to determine effects on growth and survival. He found that although larvae could not tolerate 28 ppt salinity, they survived and grew at 21 ppt salinity. Researchers at the University of California found that salinity

in the 10-12 ppt range reduced striped bass larval mortality more dramatically than any other factor investigated, and accelerated growth compared to that of fish held in fresh water (Van Olst et al. 1980).

Salinity can reduce stress associated with harvesting, handling, and transporting (Bonn et al. 1976). Low salinity water (approximately 10 ppt) is recommended to reduce osmotic stress during the handling and transport of fingerling striped bass. (See Chapter 12 for additional information.)

pH

Striped bass tolerance to pH fluctuations is age related. In fresh water, larvae were found to be very sensitive to relatively minor abrupt changes. Doroshev (1970) reported total mortality of larvae transferred to water with a change of 0.8-1.0 pH unit. However, in brackish water (4 ppt), larvae 19-28 days old survived chronic exposure to pH below 6 (Sager et al. 1986). Fingerling striped bass in fresh water were subjected to low pH by Tatum et al. (1966); the 24-hour LC₅₀ pH value was 5.3. However, in brackish water, no significant mortality was observed for fingerlings maintained in sodium bicarbonate (NaHCO₃) buffered water (pH ≥ 6.2) versus those in ambient water (pH ≥ 5.3) (Sager et al. 1986). Humphries and Cumming (1973) reported that 10 was the upper lethal pH for fingerling striped bass, but Regan et al. (1968) reported a high survival rate for striped bass fingerlings in several ponds with a pH of 10. A pH ranging between 6.7 and 8.5 (Kraeuter and Woods 1987) is considered optimum for striped bass intensive culture.

Alkalinity and Hardness

The buffering capacity of water in intensive culture systems determines the stability of a system to changes in pH. Calcium carbonate (CaCO₃) acts as a buffer to compensate for nitrogenous acids and CO₂ released by fish. Lewis et al. (1981) used crushed oyster shells as their source of CaCO₃. *Rangia* spp. (clam) shells are also a good buffering material. Crushed limestone in a filter can also be very effective, perhaps more so than shell, as a CaCO₃ source in an intensive system (J. H. Kerby, U.S. Fish and Wildlife Service, personal communication). Siddall (1974) recommended dolomite since it contains both calcium and magnesium. The total alkalinity of the intensive culture system should be maintained above 150 ppm if possible to prevent sudden changes in pH. Many prophylactic chemicals can be toxic to striped bass in low alkalinity waters (see Chapter 13).

Water hardness can be very important to striped bass, particularly in freshwater culture systems. Hazel et al. (1971) were unable to conduct bioassay experiments using well water with a total hardness of 25-30 ppm. They found that by adding salts to the soft water they could increase survival. Kerby et al. (1983a) observed that significant mortalities occurred when juvenile striped bass hybrids were moved from a system containing hard well water to soft pond water. They attributed these mortalities to osmotic shock following stress.

Water Flow

Striped bass larvae and post-larvae are relatively poor swimmers. In a natural spawning habitat, the eggs and larvae are carried along by the current. In intensive culture systems, water

flow through tanks containing young fish must be carefully regulated to prevent fish from impinging on the discharge screen. Parker (1984) suggested that water velocity be maintained at the lowest flow possible that would still maintain acceptable water quality. As fish grow and increase in size and strength, flow rate can be increased to aid in cleaning. Striped bass and hybrid striped bass are rheostatic (swim against the current). Westers (1976) suggested that relatively high flow rates may be beneficial to the stamina of fish. This hypothesis was reinforced by Leon (1983) in studies with brook trout; he reported that relatively high velocities (1.5-2 times the length of the fish in centimeters/second) enhanced stamina and growth.

Care and Handling of Fish

When striped bass or hybrid fry are received, the boxes should be opened immediately in subdued light and the sealed bags placed in the rearing systems. The bags should be opened and the temperature, DO, pH, and salinity of the shipping water determined as soon as possible. The fry should be carefully stirred in a figure 8 pattern to evenly distribute them in the bag, and an aliquot of the total volume in the bag taken for total number and mortality assessment. Water from the rearing system should be gradually and carefully introduced into the bags over a period of time ranging from 30 minutes to an hour, depending on the temperature and salinity difference. Care should be taken to monitor oxygen in the bag during tempering over extended periods of time. Avoid introducing compressed air into the bag as it can drive off CO₂, which can increase pH and toxicity of NH₃. After the fry have been carefully acclimated to the rearing system water, they can be released into the rearing tanks.

The stocking density of the rearing system must be based on its carrying capacity. Carrying capacity must be determined by several factors: (1) the size of the fish, (2) the feeding rate (expressed as % of body weight per day), and (3) input water quality (e.g., flow rate, temperature, DO, salinity, and pH). For example, if 2 pounds of fish are fed at a rate of 2% of their body weight per day, and the dissolved oxygen of the inflowing water is 11 ppm, the required flow rate for maintaining sufficient dissolved oxygen would be about 0.2 gallons per minute. To remove the CO₂, a flow rate of approximately 0.074 gallons per minute is required, and to remove the un-ionized ammonia, about 0.01 gallons per minute is needed (Colt 1986).

Lewis et al. (1981) experimentally stocked larvae into 145 gallon upflow tanks at rates ranging from 380-760 larvae/gallon. They found their tanks could successfully accommodate 380 larvae/gallon. EA Science and Technology, Inc. have operated a recirculation striped bass culture system on the Hudson River since 1982; the system has a total volume of 48,430 gallons. The hatchery was designed to hold an instantaneous peak loading equivalent to 600,000 fingerlings 3 inches long. These figures are equivalent to a maximum carrying capacity design of 12.4 fingerlings per gallon (B. R. Freidman, E. A. Science and Technology, Inc., personal communication). Once the fish reach 2 inches in length, a fish loading calculation, such as Piper's Flow Index (Piper et al. 1982), is recommended to determine carrying capacity for intensive flow through systems.

The harvest of intensively cultured striped bass or hybrids can be less traumatic than pond harvesting. Yet, the fish are still susceptible to shock and the mortality associated with handling, especially during conditions of warm water and bright light. In intensive culture, fish can be quickly and efficiently removed from culture tanks, thus minimizing exposure to conditions promoting stress or mortality. Fish concentrators can be fabricated to fit rectangular or circular tanks to crowd the fish into one area for ease of removal. While still concentrated they can be evaluated for condition, and samples can be obtained for production estimates. To minimize handling loss, fish should not be fed 2-3 days before moving or harvest. Consideration should always be given to the use of anesthetics when handling fish. Additionally, prophylactic treatments (e.g., 10 ppt salt or appropriate antibiotics) of the fish immediately after handling or harvest is recommended.

Foods and Feeding

The striped bass and hybrid striped bass is carnivorous. It has a large mouth, short esophagus, large stomach, and a relatively short intestine. Natural foods consist of a variety of zooplankton, insects, crustaceans, and fish (Harrell et al. 1977; Setzler et al. 1980; Woods et al. 1985b; see Chapter 7). The type, size, and quantity of food consumed depends primarily on the size of the fish, availability of food, and the size of the available food. Zeigler et al. (1984) suggested that striped bass probably metabolize dietary lipids and protein efficiently, but inefficiently utilize carbohydrates and fiber. They also felt that the nutritional requirements of striped bass are similar to those of trout and salmon. Unfortunately, information concerning protein and amino acid requirements of striped bass can only be inferred, as specific needs have not been established.

Artemia nauplii are considered the best live-food organisms for the early developmental stages of intensively-reared striped bass and hybrids of female striped bass origin. Brine shrimp are commercially available as cysts, and are convenient to use. The nauplii are readily accepted by larval striped bass and hybrid striped bass as long as the nauplii are not too large to be consumed by the larval fish (e.g., sunshine bass [white bass x striped bass]). Until recently, little attention was directed toward the nutritional adequacy of brine shrimp, and those from different geographic regions were considered to be nutritionally equivalent. However, we now know that differences occur from one geographic region to another, and even from year to year (depending on conditions) within the same region. The fatty acid profile of various strains of *Artemia* is of particular interest to nutritionists (Zeigler et al. 1984).

At a temperature of 59°F, some larval striped bass can be sustained up to 32 days (Rogers and Westin 1981); however, growth and overall survival was reduced. Some of the fish did initiate feeding after an extended period of starvation. Under normal culture situations, however, larvae begin feeding around day 5 and initial feeding of brine shrimp should be on day 4, depending on culture water temperature. The digestive tract is typically not complete nor capable of assimilating food before this time. The fish respond aggressively to motile organisms and will rarely feed initially on non-motile foods. The limited swimming ability of striped bass fry dictates the need for an abundance of food organisms per unit volume of water.

Lewis et al. (1981) maintained a density of 50-60 nauplii/mL from day 5 through day 15. The density was increased to between 100-120 nauplii/mL after day 15. Eldridge et al. (1981) reported that densities of 5 nauplii/mL produced rapid growth, and concentrations as low as 0.1 nauplii/mL produced some growth. Houde and Schekter (1978) held laboratory-reared marine fish larvae in concentrations of prey organisms ranging from 25-50/mL and also at 500/mL. The highest survival rates were obtained with the highest prey concentration.

Rotifers are used to feed many species of cultured marine fish larvae. *Brachionus plicatilis* has been found to be an excellent first food for several species of marine and freshwater fish (Jones 1972; Siefert 1972). Techniques for mass culture of rotifers have improved in recent years, and culture densities of 4,000 or more per milliliter are possible. Rotifers can also be used as carriers of specific nutrients for larval striped bass (Fontaine and Revera 1980).

Zooplankton, particularly the naupliar stages of copepods and cladocerans, are excellent live food organisms (Humphries and Cumming 1972). Harrell et al. (1977) and Woods et al. (1985b) considered copepods the most important food of striped bass and original hybrid striped bass (palmetto bass) less than 30 mm total length. However, procurement of these organisms in quantities large enough to feed intensively cultured fry is still a major obstacle. Nicholson (1989) used a 0.25-acre earthen pond to culture zooplankton for intensively cultured striped bass fry and fingerlings. Although several pounds of zooplankton were harvested each year, only supplemented brine shrimp nauplii and prepared trout feed.

Freeze-dried marine zooplankton have been marketed by several companies, but the size and acceptability to striped bass fry is questionable. The value of such a product to fingerlings ≥ 1 inch is also questionable, as these fingerlings will accept and thrive on commercial trout and salmon diets.

The lack of a suitable artificial diet for first-feeding fry is a major hindrance to intensive culture. Numerous attempts have been made to rear striped bass solely on prepared feeds, but larval striped bass less than three weeks of age normally do not consume or assimilate prepared diets. Prey movement is apparently important in the feeding response of striped bass. Initially, the fish's acceptance of non-motile food is generally very tentative. Striped bass can be observed taking the food particles in their mouths, quickly expelling them, and repeating the process.

Training fry to accept prepared food should therefore be started in conjunction with feeding *Artemia* nauplii. Food particle size should be approximately the same size as the brine shrimp. However, Lewis et al. (1981) found that striped bass larvae preferred food particles smaller than brine shrimp, and recommended 0.2- to 0.5-mm particle sizes.

Prepared larval food generally consists of flaked particles produced by combining various ingredients with vitamins and minerals. They are homogenized, mixed with water, pureed, and dried in flat sheets. The sheet is ground and sieved into granules of various sizes.

As fish grow, the particle size provided should be increased. Larval diets normally contain 40 to 50% (or more) protein, with a fat content ranging from 6-12% or higher. The salmon-type starter diet normally used for striped bass contains 48-55% protein and 13-17% fat. Millikin (1982, 1983) experimentally fed 2.5 g fish a diet with crude protein levels of 34%, 44%, and 55%. From a 6-week study, he found the highest protein level produced the highest weight gain and food conversion rate. Larval starter diets (e.g., salmon starter) should be replaced by day 35, or whenever the fish can accept a larger particle, with number 1 crumble-size fish food. This increase in food particle size should be adjusted on a regular basis (approximately every other week) depending on the growth rate of the fish. Zeigler et al. (1984) listed examples of commercially available fish foods and the approximate size range in millimeters, from larval food through adult sized pellets. (See Table 9.1 for further information on appropriate particle sizes for fishes of different size.)

The nutritional value of food should be carefully considered and efforts made to prevent the vitamin content from being diminished due to improper storage. Vitamins, especially vitamin C, are quickly lost when the food is stored in a warm, moist environment. Zeigler et al. (1984) recommended that fresh food be purchased regularly, and food inventories rotated, to help ensure nutritional quality.

The importance of providing sufficient amounts of food in a timely manner was described by Van Olst et al. (1980). Although brine shrimp were manually introduced into striped bass culture tanks on an occasional basis, the authors could not maintain a feeding schedule to meet the nutritional needs of striped bass larvae, and by not supplying sufficient food continuously during the first 14 days, numerous fish starved to death. The lack of food also contributed to cannibalism. Results of the study prompted the culturists to develop an automatic brine-shrimp feeder. Similar experiences at the Gulf Coast Research Laboratory with manual feeding of striped bass also resulted in development of an automatic live food fish feeder (Nicholson et al. 1985).

Paller and Lewis (1987), while investigating the relationship between diet, growth, and cannibalism, found that fish of the same size differed in their ability to adapt to formulated feeds. They introduced brine shrimp nauplii in large numbers and subsequently changed the diet to a combination of nauplii and formulated feed. The striped bass fed high numbers of brine shrimp maintained a high growth rate and showed little tendency to cannibalize. In tests that provided striped bass with an abundance of formulated foods, but very few brine shrimp nauplii, fish grew significantly slower, and were more cannibalistic.

Feed types recommended by Lewis et al. (1981) for striped bass reared at their optimum temperature for growth are provided in Table 10.1. From day 5 through 30, Lewis et al. (1981) fed brine shrimp nauplii to striped bass at hourly intervals, 24 hours per day. Dry feeds were fed 12-16 times per day.

At Crane Aquaculture Facility (Maryland), live brine shrimp nauplii were offered every 15 minutes by automatic feeders (Figure 10.3), 24 hours per day from day 5 through 30. Dry

Table 10.1. Recommended feed types provided by Lewis et al. (1981) for a given age striped bass reared under intensive culture conditions.

Age of fish (days post-hatch)	Food type
5-11	live brine shrimp nauplii
12-17	pulverized flake and live brine shrimp nauplii
18-22	pulverized flake, pulverized starter, and live brine shrimp nauplii
23-30	pulverized starter, starter, live brine shrimp nauplii
31-35	starter
36-40	starter and 2/64 salmon feed
41-45	2/64 salmon feed
46-50	2/64 salmon feed and 3/64 salmon feed
51-60	3/64 salmon feed
61-75	3/64 salmon feed and 4/64 salmon feed
76-	4/64 salmon feed

salmon diets were fed by automatic feeders every 5 minutes, 24 hours per day from day 20 through 40 (L. C. Woods III, unpublished data).

Problems Frequently Encountered

It has been clearly established by numerous investigators that cannibalism can result in drastic losses in intensive culture systems (Lewis et al. 1981; Braid and Shell 1981; Woods et al. 1981; Nicholson 1989). Cannibalism is especially prevalent during conversion from live to prepared diets, so grading to remove the larger fish must be performed at least every two to three weeks when the fish are between 4 and 10 weeks of age.

Failure of the striped bass larvae to inflate their gas bladder (Figure 10.4) is another problem frequently encountered, and has been described by Doroshev and Cornacchia (1979), Bulak and Heidinger (1980), and Bennett et al. (1987). However, mechanisms which enhance or preclude proper inflation are still unknown. Whether a non-inflated air bladder can be subsequently inflated is still speculative. It appears that larvae need access to air at the water surface to properly inflate their gas bladders (Chapman et al. 1988).

Lastly, diseases can be devastating in intensive culture due to proximity and crowding. Treatment can be complicated, especially in water re-use systems where the treatment can disrupt the filtration efficiency of the system. Therefore, specific steps must be taken to prevent diseases and to treat diseases that occur. (For more information on diseases and treatments refer to Chapter 13.)



Figure 10.3. Automatic brine shrimp hatching cones and feeders in use at the Crane Aquaculture Facility, Baltimore, Maryland. Photo Credit: Baltimore Gas and Electric Company.



Figure 10.4. Swimbladder inflation in striped bass. Photo Credit: James A. Bulak.

Hybridization, Genetic Manipulation, and Gene Pool Conservation of Striped Bass

Jerome Howard Kerby and Reginal M. Harrell

The original objective of the *Morone* hybridization program initiated in the 1960s was to produce a fish that combined some of the more desirable characteristics of two parent species (Bayless 1972; Bonn et al. 1976). Preferred characteristics included the size, longevity, food habits, and angling qualities of striped bass (*Morone saxatilis*), and the adaptability of white bass (*M. chrysops*) to exotic environments.

R. E. Stevens produced the first hybrids between female striped bass and male white bass (SB x WB) in South Carolina in 1965 (Bishop 1968). It has since been demonstrated that striped bass hybrids show heterosis (hybrid vigor), expressed as improved survival, superior early growth rates, greater disease resistance, and increased general hardiness (Bishop 1968; Logan 1968; Williams 1971; Bayless 1972; Ware 1975; Bonn et al. 1976; Kerby and Joseph 1979; Kerby et al. 1983a; Kerby 1986). As a result, this hybrid has been artificially propagated and widely stocked in freshwater impoundments for control of shad (*Dorosoma* spp.) and as a food and sport fish. More recently, the reciprocal of the original cross, female white bass x male striped bass (WB x SB), has been used similarly, and its popularity with management biologists and commercial aquaculturists has increased dramatically over the last few years. In 1981, about 40 million striped bass and hybrid fingerlings were produced in 17 state and federal hatcheries for stocking in inland waters. At that time, more than 264 reservoirs were stocked with hybrids (Stevens 1984). Stevens noted that hybrids are preferred over striped bass for smaller impoundments and that they appear to fare better than striped bass in warmer waters.

Several additional crosses, such as striped bass x white perch (*M. americana*), striped bass x yellow bass (*M. mississippiensis*), and various backcrosses and outcrosses have also been made, but none have gained the acceptance of the first SB x WB cross (Smith et al. 1967; Bayless 1968, 1972; Bishop 1968; Kerby 1972; Ware 1975). A number of these crosses are discussed in more detail later. Table 11.1 lists each cross and its official common name as recognized by the Striped Bass Committee, Southern Division, American Fisheries Society.

We use the accepted convention of placing the female first when referring to a specific hybrid cross, and refer to the various hybrids by the common names designated in Table 11.1.

Table 11.1. Common names of striped bass hybrids recognized by the Striped Bass Committee, Southern Division, American Fisheries Society.

Female	Male	Common name
Striped bass	White bass	Palmetto bass
White bass	Striped bass	Sunshine bass
Striped bass	White perch	Virginia bass
White perch	Striped bass	Maryland bass
Striped bass	Yellow bass	Paradise bass

For example, SB x WB is always the striped bass female x white bass male. The first cross (original hybrid) produced (SB x WB) is the palmetto bass, and the reciprocal hybrid (WB x SB) is the sunshine bass.

Past performance of hybrids suggests that their use in management and recreational programs will continue to increase. Since hybrids were first produced, advances in culture and rearing have opened extensive new management and recreational opportunities in inland lakes and reservoirs. Additionally, recent research (Kerby et al. 1983b, 1987a,b; Smith et al. 1985, 1989; Kerby 1986; Harrell et al. 1988; Smith 1989) has demonstrated that hybrids have extraordinary potential for commercial aquaculture.

Descriptions

In general, adult *Morone* are fairly easy to distinguish anatomically, but the hybrids are generally intermediate in appearance (Figures 11.1-11.4); they exhibit more variability, and some of the crosses — especially backcrosses and second generation (F₂) crosses — may be difficult to distinguish from the parents by gross examination. Yet, F₁ hybrids can be readily distinguished from the parents by a number of morphometric and meristic traits (Bayless 1972; Williams 1976; Kerby 1972, 1979, 1980; Harrell 1984b; Waldman 1986; Harrell and Dean 1987, 1988). Accurate identification of backcrosses and F₂ hybrids depend on biochemical (electrophoretic or isoenzyme) analyses (Avisé and Van Den Avyle 1984; Todd 1986; Crawford et al. 1987; Forshage et al. 1988; Fries and Harvey 1989) or genetic analyses using mitochondrial or nuclear DNA (Chapman 1989) (R. W. Chapman, Chesapeake Bay Institute, The John Hopkins University, personal communication).



Figure 11.1. Comparison between white bass (top), striped bass (middle), and palmetto bass (bottom). Photo Credit: Tennessee Wildlife Resources Department.

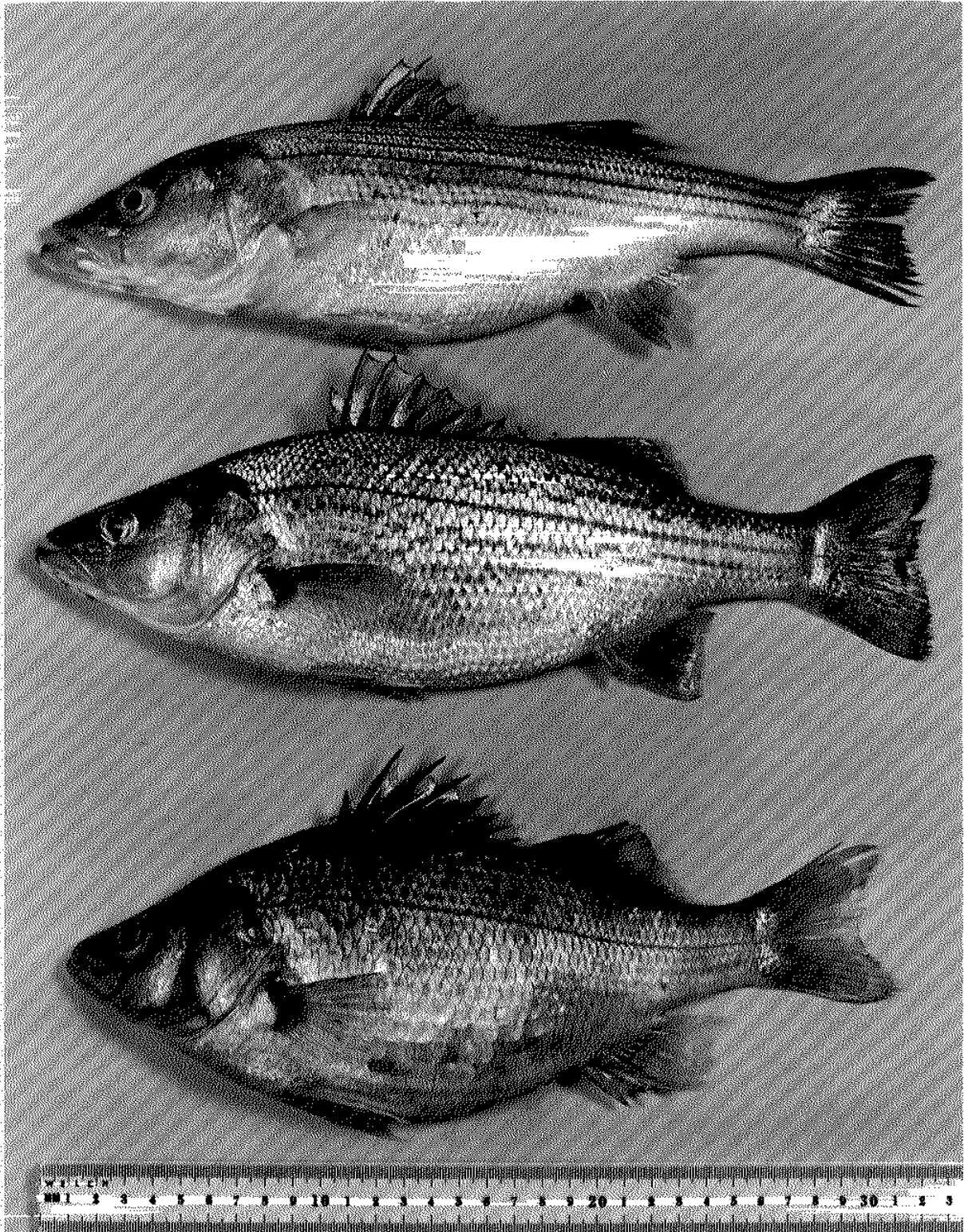

Figure 11.2. Comparison between striped bass (top), Virginia bass (middle), and white perch (bottom). Photo Credit: J. Howard Kerby.



Figure 11.3. Comparison between Virginia bass (top) and palmetto bass (bottom). Photo Credit: J. Howard Kerby.



Figure 11.4. Comparison between palmetto bass (top), palmetto bass x striped bass (middle), and striped bass (bottom). Photo credit: Reginal M. Harrell.

According to Dr. Ike Wirgin, tests using oncogene probes as nuclear DNA markers to identify hybridization and measure introgression among *Morone* species indicate that a single oncogene probe can be used to identify *Morone* hybrids, and the use of several different probes should allow a determination of the extent of introgression within the parental species. Further, DNA fingerprinting screens for the number of short, highly repetitive DNA sequences that are located in the nuclear genome may provide an efficient method for screening hatchery brood stock to maintain genetic integrity of stocks and to maximize genetic diversity. The method is currently being used as a genetic tag to identify Gulf and Atlantic striped bass in a performance evaluation in a system with no natural reproduction (Ike Wirgin, A. J. Lanza Laboratories, personal communication).

Gross examination may allow classification of a fish as an F_1 hybrid or a pure species from a broad perspective. For example, palmetto bass and sunshine bass can be separated from striped bass because the hybrids have a deeper body, a smaller head, a shorter and broader caudal region, and the head is sloped at a more acute angle (Figures 11.1-11.4). Hybrids always have interrupted stripes, but striped bass often have this characteristic as well. Palmetto bass can be readily distinguished from Virginia bass because the dorsal fins of the Virginia bass are almost always connected, and the coloration of the back is a darker olive green — a result of greater melanophore density. These characteristics are inherited from the white perch parent. Although meristic or morphometric traits (Figures 11.5-11.8) can often be used to distinguish various hybrids and parental species, they may not always suffice to correctly identify an individual hybrid (Harrell and Dean 1988). However, combinations of the two measurements often enable correct identification.

We recommend that the reader obtain copies of works by Bayless (1972), Williams (1976), Kerby (1979, 1980), Harrell (1984b) and Harrell and Dean (1987, 1988) to assist in making correct identifications. Although these publications generally corroborate each other, it is important to carefully consider the information provided in all of them because the fish used in the studies differed in size and came from different geographical locations; moreover, some of the crosses differed in maternal heritage. The same is true if one wishes to use pterygiophore-interdigitation pattern analysis, a technique in which bone structure and configuration are examined to identify the crosses in question (Fritzche and Johnson 1980; Olney et al. 1983; Harrell 1984b; Harrell and Dean 1987).

Biochemical and genetic techniques continue to improve. If greater accuracy is needed, one can begin by making an identification that uses the techniques referred to above, and then corroborate them with newer procedures. These procedures are most accurate if live or frozen controls of known crosses are available for comparison.

General Comparisons of Hybrids

It is of particular interest that, unlike many fish hybrids, all F_1 *Morone* crosses that have been reared to maturity and evaluated have been fertile when induced to spawn in a hatchery situation (Bayless 1972; Harrell 1984c; Smith and Jenkins 1984; Stout and Drda 1986; Harrell and Dean 1987).

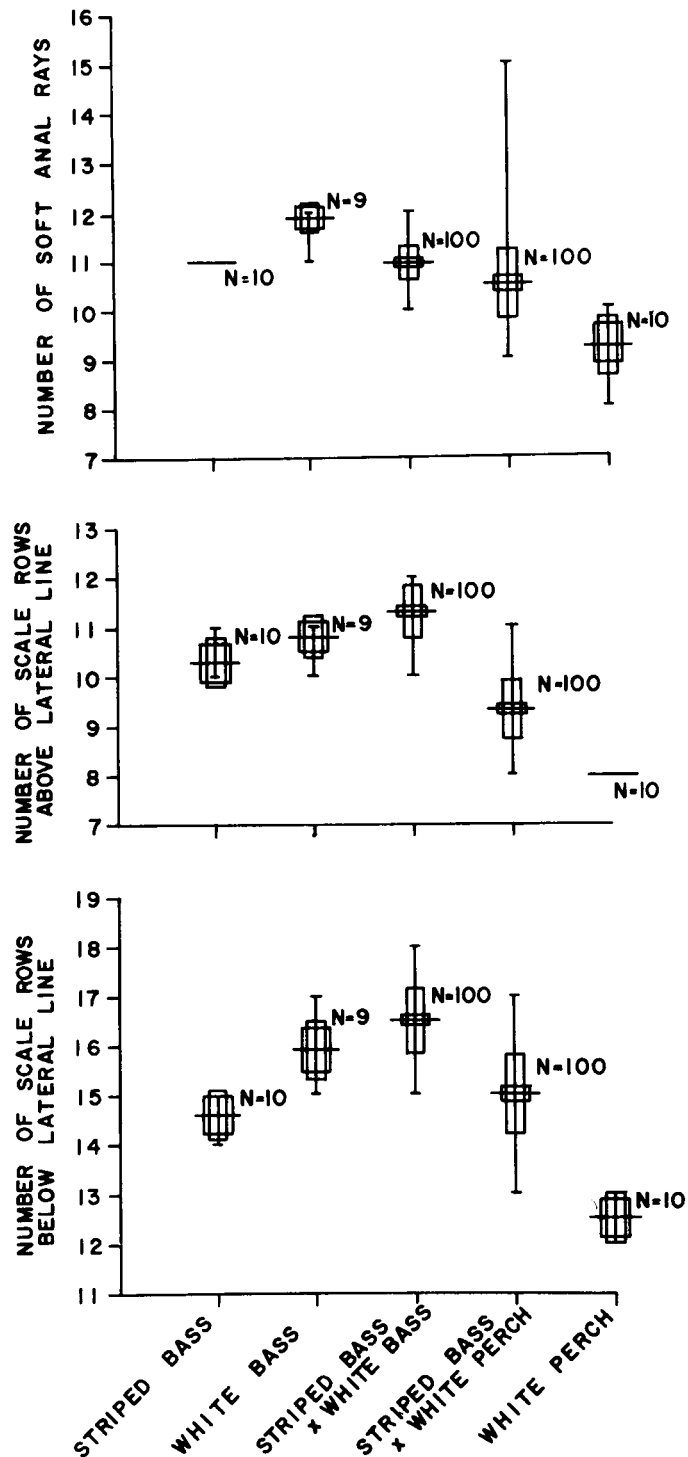

Figure 11.5. Number of anal soft rays and scale rows above and below the lateral line, showing range, mean, standard deviation, and confidence interval for *Morone* hybrids and their parents. Centered vertical line = range; centered horizontal line = mean; box of lesser horizontal width = standard deviation; and box of greater horizontal width = confidence interval, $S_x t_{.05}$ (from Kerby 1979).

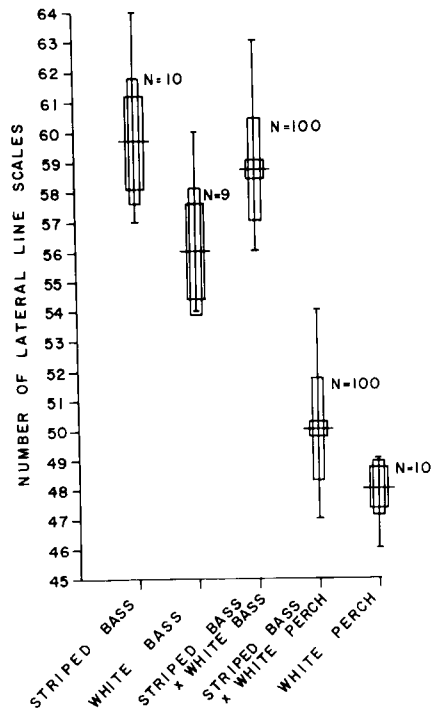

Figure 11.6. Number of lateral line scales, showing range, mean, standard deviation, and confidence interval for *Morone* hybrids and their parents. See Figure 11.5 for identification of symbols (from Kerby 1979).

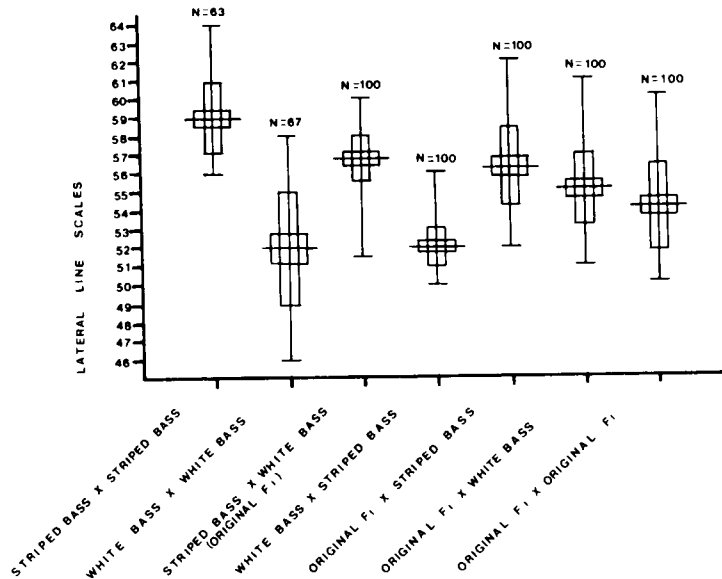

Figure 11.7. Number of lateral line scales, showing range, mean, standard deviation, and confidence interval for *Morone* hybrids and their parents. See Figure 11.5 for identification of symbols (from Harrell and Dean 1988).

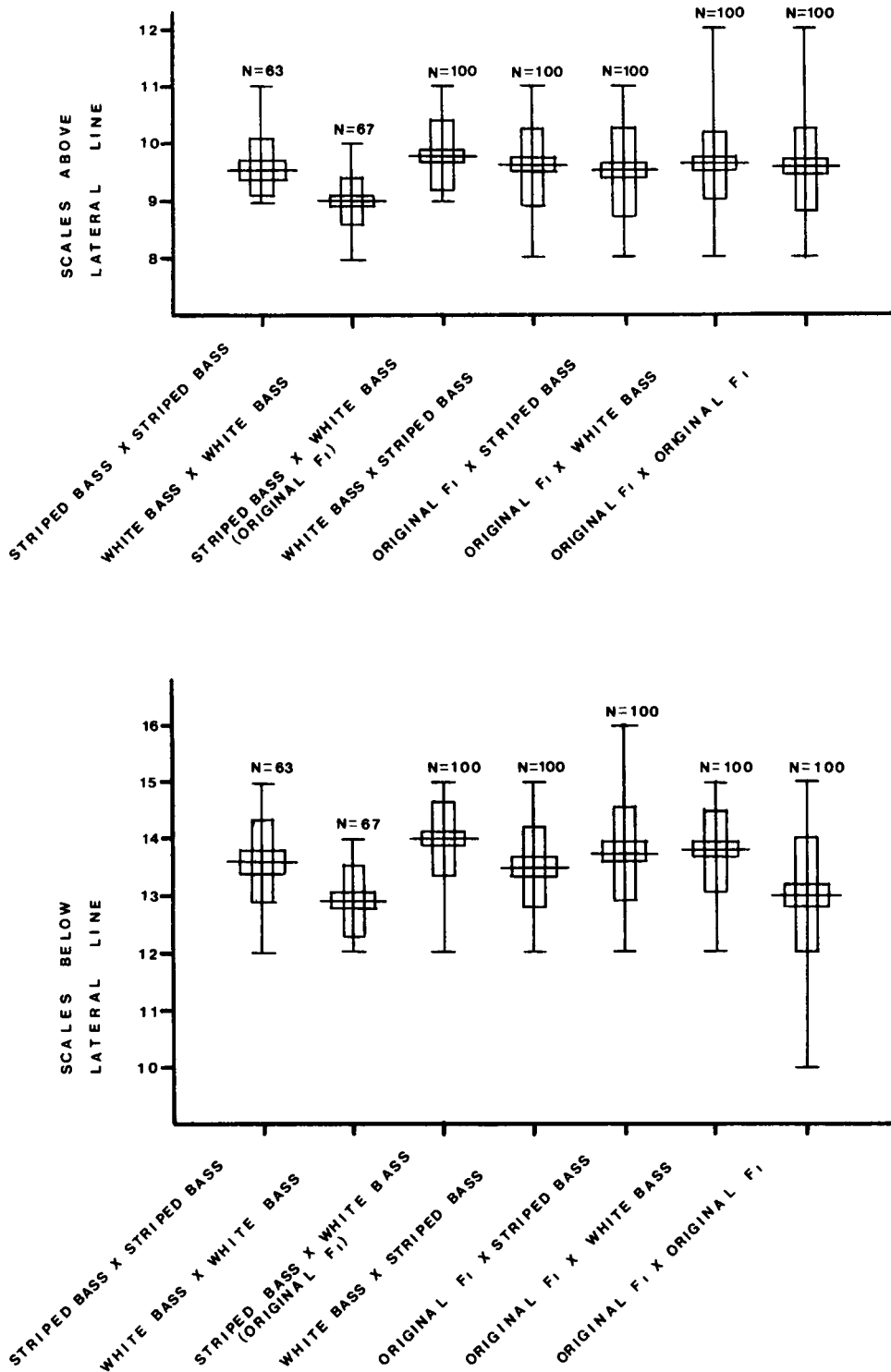

Figure 11.8. Number of scale rows above and below the lateral line, showing range, mean, standard deviation, and confidence interval for *Morone* hybrids and their parents. See Figure 11.5 for identification of symbols (from Harrell and Dean 1988).

Palmetto Bass

As previously noted, palmetto bass (striped bass x white bass) was the first cross, and it continues to be the hybrid most widely-used in recreational and management strategies. It is considerably hardier than striped bass as demonstrated by its higher average survival rates during culture and its ability to establish sport fisheries from fry stocking. Growth is rapid, and can be exceptional under optimal conditions (Bishop 1968; Bayless 1968, 1972; Logan 1968; Bonn et al. 1976; Kerby and Joseph 1979; Smith et al. 1985). Recent work has demonstrated that it is a particularly viable candidate for commercial aquaculture.

Sunshine Bass

First produced by Bayless in 1966 in South Carolina (Bayless 1968), sunshine bass were not successfully cultured until 1973 in Florida (Ware 1975). This hybrid, like the palmetto bass, is hardy and grows rapidly. Although it has not been widely accepted because its adhesive eggs and small larval size originally posed production problems, recent advances in culture techniques and information concerning the performance of sunshine bass indicate that it may be a more viable candidate. The fact that white bass females are more readily available to commercial culturists and are somewhat easier to spawn than female striped bass has also led to increased acceptance of the sunshine bass.

Virginia Bass

Smith et al. (1967) first produced Virginia bass in North Carolina in 1966. Since then, it has been stocked in a few small impoundments. It has also been cultured and sold, together with palmetto bass, in commercial outlets in marketing trials (Huish et al. 1987). It is hardier than the palmetto bass, and is more tolerant of stress from transport and transfer to soft water, but its growth rates are highly variable, being generally slower than those of palmetto bass (Kerby and Joseph 1979; Smith and Jenkins 1985; Huish et al. 1987; Kerby et al. 1987b). The two crosses involving white bass are now considered to be better candidates for recreational fisheries and commercial aquaculture because of their faster and more consistent growth rates.

Maryland Bass

Maryland bass were first produced by one of us (J. H. Kerby) in 1969 at the Virginia Institute of Marine Science, but has not been reared beyond the fingerling stage (J. H. Kerby, unpublished data). It is currently being re-examined at the University of Maryland by R. M. Harrell (unpublished data). Its characteristics are not well defined, but are likely to be similar to those of the Virginia bass.

Paradise Bass

First produced in Virginia in the late 1960s in a cooperative effort between Kentucky and Virginia (Ware 1975), paradise bass have been stocked in some locations, particularly in Louisiana (J. S. Hughes, Louisiana Wildlife and Fisheries Commission, personal communication), but little information is available about its characteristics.

Palmetto Bass x Palmetto Bass

This F₂ hybrid was first produced in South Carolina (Bishop 1968; Bayless 1972). It is less hardy than the F₁ or parental species, survival is generally poor, and growth rates (and morphology) are highly variable (Smith et al. 1985; R. M. Harrell, unpublished data; J. H. Kerby, unpublished data). It has been generally dismissed as an aquaculture candidate.

Striped Bass x Palmetto Bass

The only backcross for which any growth and survival characteristics under culture conditions are currently known, striped bass x palmetto bass was first produced in South Carolina in 1967. Early reports (Bayless 1968; Bishop 1968) indicated significant deformities, but later production by Bayless, without the deformities originally noted, was mentioned by Ware (1975). Preliminary experiments by Kerby et al. (1987b) to examine its aquaculture potential indicated that it is hardy, with growth rates similar to those of palmetto bass.

Bayless (1972) determined that males of this backcross were fertile and produced an F₂ backcross, striped bass x (striped bass x palmetto bass). He reported that all larvae produced were grossly deformed and died within a few hours after hatch. However, these results should be checked by additional work.

Palmetto Bass x Striped Bass

Also first produced in South Carolina in 1969 (Bayless 1972), we have produced this backcross on several later occasions in conjunction with other experiments. Fingerlings were cultured to subadults, but growth characteristics were not evaluated (Harrell 1984b). Larvae are relatively easy to produce and are vigorous. Ware et al. (1976) reported that growth and survival of this backcross to the fingerling stage was comparable to striped bass, and that anomalies were not significant. Assuming that this backcross is hardy and has growth characteristics similar to those of the striped bass x palmetto bass, it may be an alternative for commercial culture.

Palmetto Bass x White Bass

Harrell (1984b) first produced this cross for descriptive purposes. It has not yet been evaluated for growth and survival or aquaculture potential.

White Bass x Palmetto Bass

Bayless (1972) first produced this backcross, but only 1 of about 50,000 larvae survived to the fingerling stage. To our knowledge, no additional work has been done on this backcross.

Palmetto Bass x Virginia Bass

We first produced this "trihybrid" cross in South Carolina in 1983, and on several occasions thereafter (J. H. Kerby, unpublished data). The larvae appeared to be vigorous and viable, but lack of suitable ponds precluded their culture. This form represents a highly interesting cross, particularly if the hardiness of the white perch hybrid can be incorporated into the offspring without seriously decreasing growth rates. Guest (1987), who worked with centrarchids, reported that growth of trihybrid sunfish (produced by outcrossing F₁ hybrids with a third

species) was generally better than that of parental species or F_1 hybrids. Thus, this and other *Morone* trihybrids should be evaluated for aquaculture potential.

Virginia Bass x Palmetto Bass

This reciprocal trihybrid was first produced in North Carolina in 1987 (J. H. Kerby, unpublished data). Fry were cultured to phase I fingerlings in a pond at Keo Fish Farm, Arkansas, and a few specimens were preserved in buffered formalin. Fingerlings were hardy, and after harvest were re-stocked into a pond containing forage fish. Unfortunately, the pond dikes later collapsed during a flood and the fish were lost (T. M. Freeze, Keo Fish Farm, Inc., Keo, Arkansas, personal communication). This is another cross that may have aquaculture potential for the same reasons cited for the palmetto bass x Virginia bass, but it requires extensive evaluation.

Other Crosses

Other backcrosses and outcrosses have been produced, but little is known about their characteristics because no evaluations have taken place. The outcrossing of palmetto bass and white perch might be another way of increasing the hardiness of fish used for commercial culture.

Production of Hybrids

Acquisition of Brood Stock

Most brood stock used in the production of striped bass hybrids are obtained from natural stocks in the wild. Sources depend entirely on location. Striped bass and white perch are primarily anadromous estuarine species, although both now occur in land-locked freshwater impoundments. White bass and yellow bass are primarily freshwater species that are seldom found in estuarine environments.

All *Morone* species are anadromous or potamodromous, moving upstream in spring and aggregating on or near the spawning grounds. Collection of fish near the spawning grounds is easiest and yields an added advantage, in that these fish are more likely to be naturally ripe or to be eligible for induced ovulation with hormones.

Electrofishing is the preferred method of collecting brood stock because it is less stressful than other methods (Harrell 1989); however, a variety of other methods are often used as well, such as various types of gill nets, traps, haul seines, and hook-and-line (Harrell 1984a). (Detailed information on collection methods is given in Chapter 4.)

The spawning temperatures of white bass and white perch are somewhat lower than those of striped bass. In the southern states, both species normally begin spawning runs when water temperatures reach 55-60°F. Peak spawning of these species typically occurs 2 to 3 weeks before that of striped bass in the same areas. Bonn et al. (1976) observed that white bass females have three separate openings in the cloacal region, compared to two in the males, allowing

sexes to be determined morphologically. We have observed that white perch and hybrid females have similar morphological characteristics.

We believe that domesticated brood stock will play an increasing role in hybrid production in the future, particularly where hybrids are being used in commercial operations. Striped bass males and hybrids between striped bass and white bass or white perch are relatively easy to rear to maturity. Under optimum growing conditions, male striped bass and hybrids of both sexes can mature and spawn in 2 years. The same is believed to be true for white bass, although there has been much less experience in their culture. In contrast, striped bass females normally require at least 4 years to mature. It is probably not economical to spawn females that weigh less than 12 pounds, and the results of past experience in spawning female striped bass grown in ponds or tanks have been inconsistent.

Production of Larvae

Methods for producing palmetto bass are similar to those described in Chapter 5 for striped bass, except that male white bass are used instead of male striped bass. Rates of injection of human chorionic gonadotropin (HCG) for male white bass are usually 100-200 international units (IU) per pound of body weight (Chapter 5). These rates appear appropriate for white perch and yellow bass as well. At present, because successful tank spawning has not yet been effected between the different species of *Morone*, hybrids must be produced by manually stripping ripe eggs and milt from the parental species. However, first generation palmetto bass have been successfully spawned in tanks to produce F₂ hybrids (Harrell 1984c; Smith and Jenkins 1984). Natural hybridization between white bass and white perch, white bass and yellow bass, and natural backcrossing of hybrid striped bass with striped bass have also been reported (Todd 1986; Forshage et al. 1988; Fries and Harvey 1989). Crawford et al. (1987) reported suspected natural hybridization between striped bass and white bass in Arkansas. These reports suggest that it may be possible to induce tank spawning between species if the required conditions are provided.

"Wet" fertilization, where eggs and sperm are stripped simultaneously into a dishpan containing 2 or 3 L of hatchery water, is preferred by many culturists for producing palmetto bass. Bayless (1972) and Starling (1985) suggested that this method works better than the "dry" method because copious amounts of urine that accompany semen when male white bass are stripped may prematurely activate spermatozoa. Some hatcheries use a modified "wet" fertilization method in which semen and water are added simultaneously to the eggs. Bayless (1972), Bonn et al. (1976), and Starling (1985) provided detailed descriptions of these procedures, and further information is provided in Chapter 5.

Methods for producing hybrids by using females other than striped bass or F₂ crosses, as well as backcrosses with F₁ females, are somewhat more complicated. Eggs from white bass, white perch, and yellow bass are considerably smaller than those from striped bass and are highly adhesive, making typical jar culture difficult. Masses of eggs stick together and form a substrate that promotes fungus infections. Eggs from F₁ hybrids are intermediate in size between those of striped bass and the other *Morone* species. Most F₁ eggs are also adhesive, but

are less so than those of non-striped bass *Morone* species. Fertilization and spawning procedures should be handled similarly for these species and for hybrids.

Ripe eggs from white bass, white perch, yellow bass, and F₁ hybrids are typically yellow to golden. In contrast, ripe striped bass eggs are of various shades of green, ranging from pale green to blue-green. When striped bass males are crossed with females of other species or F₁ hybrids, females are normally injected with doses of HCG ranging from 500 to 1,000 IU/pound (Bonn et al. 1976; Starling 1985). Dose rates as low as 50-75 IU/pound stimulate semen flow in male striped bass (Bishop 1975).

A small glass or polyethylene catheter (1.5-2.0 mm outside diameter) can be used to obtain eggs from white bass, white perch, and yellow bass to determine eligibility for hormonal inducement of ovulation and to predict ovulation. Probably less damage to oviduct tissue is caused by the plastic catheter (1.5 mm outside diameter) described by Smith and Jenkins (1988a) than by a glass catheter. Egg development preceding ovulation in these species is similar to that described for striped bass (see Chapter 5), and Bayless (1972) described it in more detail for white bass. However, in contrast to the development of striped bass eggs, the development of white bass eggs is almost always mixed, and when the majority of eggs ovulate, a significant proportion (which can range as high as 40%) are in various stages of development (Bayless 1972). This condition probably occurs because females of these species are naturally intermittent spawners and may take several days to complete spawning.

Because the eggs are highly adhesive, they cannot be incubated normally in hatchery jars unless the adhesive material is neutralized. This material also forms a mucoid covering that renders the eggs almost opaque during incubation, which makes it very difficult to determine fertilization percentages and to observe embryonic development. Numerous methods have been used to reduce the adhesiveness and to clear or remove the material so that fertilization and development can be observed. Fuller's earth, silt, clay, starch, sodium sulfite, and tannic acid are a few of the materials that have been tried with varying degrees of success.

Bonn et al. (1976) recommended that white bass eggs be incubated in aquaria at a density of no more than 20,000 eggs per 20 gallons of water. Techniques have since improved, allowing incubation in hatchery jars. Although techniques are still not completely satisfactory, they are far superior to the aquarium method.

Fertilization technique. The technique we recommend for fertilization was developed and modified over a period of several years at Florida's Richloam Fish Hatchery (Starling 1983, 1985, 1987; Rottmann et al. 1988; C. C. Starling and W. H. Revels, Florida Game and Fresh Water Fish Commission, personal communication). Details of the technique follow.

Place a solution containing 20 g of sodium chloride (NaCl), 15 g of urea, and a small drop of an antifoam compound (dimethylpolysiloxane) in 5 L of hatchery water in each hatchery jar immediately before spawning. Treatment of eggs with this solution will help clear them so that developmental events can be seen through the chorion. Prepare a second solution con-

taining 0.75 g of tannic acid in about 5 L of hatchery water, yielding a concentration of about 150 ppm. When ripe eggs are taken, fertilize them dry with copious amounts of striped bass semen from at least two males and mix it thoroughly with the eggs. Add just enough hatchery water to activate the spermatozoa and stir for at least 1 minute. Starling (1985) suggested that the mixture should look like "a bowl of very creamy cereal." Rottmann et al. (1988) noted that a large volume of milt seemed to reduce egg adhesiveness.

Add the eggs to the salt-urea solution containing a weighted air stone and aerate *vigorously* for 7 to 10 minutes. Remove the airstone, let the eggs settle, and decant the water. Add the tannic acid solution to the eggs and again aerate vigorously for 6 or 7 minutes. The vigorous aeration will keep the eggs from adhering to each other during treatment. After treatment, remove the air stone and insert the tube supplying the inflowing incubation water. Adjust the water flow to keep the eggs in suspension and actively "rolling" in the jars. Rottmann et al. (1988) advised that if eggs begin to clump during the incubation process, the tannic acid treatment can be repeated; they stated that over a million eggs can be treated and incubated in a single 7-L jar, but recommended a maximum of 250,000 eggs per jar.

Tannic acid treatment has an additional advantage in that it appears to have anti-fungal properties, particularly if eggs are treated for longer periods (10-12 minutes was recommended by Rottmann et al. 1988). However, tannic acid also toughens the chorion. Because use of excessive amounts or extended treatment times can significantly delay or reduce larval hatch, care should be exercised in its use. We have observed apparently normal, active larvae that were unable to break free of the chorion. Delay in hatching due to the toughened chorion can also result in increased susceptibility to fungal infections. Starling (1985) suggested that a flush treatment with 5 ppm malachite green be given 35 hours after fertilization to retard fungal infections through hatching. Formalin has also been used (286-429 ppm) as a prophylactic by injecting 2 or 3 mL of full strength formalin (ca. 38% formaldehyde) into the top of shad tubes (see Chapter 2) to provide a rapid flush treatment, but it is probably less effective than malachite green. *We emphasize that malachite green is not registered for use on food fish.* However, some hatcheries are permitted to treat striped bass fry and fingerlings with this chemical under a special permit from the U. S. Food and Drug Administration.

Embryogenesis of hybrids produced with white bass, white perch, and yellow bass eggs closely parallels that described for striped bass by Bayless (1972), but the incubation period is normally longer than that of striped bass at the same water temperature.

Production of Phase I Fingerlings

Techniques used for pond culture of hybrid larvae to phase I fingerlings (1-2.5 inches long) are essentially the same as those described in Chapters 7 and 8 for striped bass and are not repeated here. However, hybrid larvae produced from females of species other than striped bass are about one-third smaller than striped bass or hybrids produced from striped bass eggs. These larvae are normally ready to feed when they are 4 days old if water temperatures are $\geq 66^{\circ}\text{F}$ and should be stocked by that time. Furthermore, they cannot be maintained or intensively cultured with brine shrimp nauplii because their mouth size is too small to ingest the

nauplii (except, perhaps, those of the Brazilian strain). Greater care should also be exercised in pond filling and fertilization. Because of their smaller size, time of stocking (in relation to filling and fertilization) is more critical to ensure the availability of appropriate zooplankton. The fry are also more vulnerable to predation than striped bass or hybrids produced from striped bass females. In general, these smaller hybrids should be stocked in ponds that are in the early phases of a bloom, when rotifers and the smaller crustaceans, such as early copepod instars, are most abundant, rather than in more mature ponds where larger crustaceans, such as adult copepods and cladocerans, predominate. Depending on climate and other conditions at specific hatchery locations, it may be prudent to stock from one to several days earlier (after the pond is filled) than one would normally stock striped bass or hybrids produced from striped bass females.

Determination of survival is also more difficult for these hybrids. Because of their size and relative transparency, they are almost impossible to see by the spotlighting technique described in Chapter 8 until they have been in the pond for several days to 2 weeks.

Ponds should normally be harvested when the hybrids are 1-2 inches long. Procedures for harvest, holding, and transport are described in Chapter 8.

Production of Phase II Fingerlings

Techniques for production of phase II hybrids (3-10 inches) are generally similar to those described in Chapter 9, but three points should be especially emphasized: First, when phase I fingerlings are harvested, they should be carefully graded according to size before they are put into holding tanks or raceways. Severe cannibalism can result if fish of different sizes are held together. Second, if possible, the fingerlings should be held in 10 ppt salt continuously for 1 to 2 days to reduce stress. Salinity should then be gradually diluted with hatchery water over an additional 2-day period until replacement with ambient hatchery water is complete. Treatments with formalin, potassium permanganate, or other chemicals can also be made at this time. Third, the fish should be trained to feed on a commercial diet before they are re-stocked in ponds. Although nutritional requirements for striped bass and hybrids are not defined, high-protein salmon diets of high quality have worked well for phase I fingerlings through a #4 crumble size. In general, when fish are large enough to take food larger than #4, they can be transferred to a high quality trout diet, which typically contains about 38% protein. Catfish or "pondfish" diets containing similar amounts of protein should not be used because they typically do not provide the high quality that *Morone* spp. require.

If fish are crowded under good environmental conditions, they should begin to accept feed within a day or two and be fully trained in about 7 to 10 days. They can then be returned to the ponds for further growth to phase II.

Optimum stocking rates for hybrid striped bass have not been well defined, although rates of 8,000 fingerlings or more per acre have been successful. Survival can normally be expected to exceed 80%, barring oxygen depletion or other problems with water quality, disease, or predation (Kerby et al. 1983b, 1987a; Stout and Drda 1986; Jenkins et al. 1989). However, if

fish are stocked at high densities, backup aeration systems should be available. (Chapter 9 provides further insight.)

To maximize growth rates, we recommend feeding to satiation at least three times daily. Hand feeding helps the culturist maintain a better perspective concerning conditions in the pond and improves management decisions, but automatic feeders or blowers reduce manpower requirements. Feeding rates normally should be estimated as a minimum of 5% of fish biomass per day if satiation feeding is not practiced (Tuncer et al. 1990). Feeding activity should be monitored carefully, and feeding rates adjusted as necessary to promote rapid growth and to avoid waste (which can lead to water quality problems).

Ponds should not be harvested until the weather cools, when fish are less subject to stress. At harvest, they should be given treatments to reduce stress similar to those provided to phase I fingerlings. Depending on size differences between individuals, the culturist may wish to grade the fish before re-stocking them for further culture.

Production of Phase III — Subadults and Adults

Culture of hybrids to subadult or early adult sizes (0.7-4 pounds) is seldom practiced except when the objective is commercial food-fish production or research. If phase II hybrids are to remain in ponds throughout culture to phase III, initial stocking rates of phase I hybrids should be adjusted and managed according to projected standing crops at harvest. If phase II fingerlings are harvested and re-stocked for phase III culture, we currently recommend that they be re-stocked at about 3,000-4,000/acre, if adequate aeration systems are available and sufficient volumes of fresh or brackish water can be provided to the pond in the event of oxygen depletion or other water quality problems. Assuming 80% survival, and an average weight of 2 pounds at harvest, this procedure would result in a standing crop of 4,800-6,400 pounds/acre.

Although hybrids can survive short-term exposure to concentrations of 1-2 ppm dissolved oxygen, we recommend that dissolved oxygen levels be maintained above 6 ppm whenever possible to avoid stress and ensure the best growth rates. As for phase I fingerlings, high quality commercial trout diets appear to provide adequate nutrition for rapid growth and high survival. A number of recent publications provide additional information on culture to phase III (Kerby et al. 1983a,b, 1987a; Woods et al. 1983, 1985a; Kerby 1986; Jenkins et al. 1989; Smith et al. 1989). (More specific details for phase III culture are outlined in Chapter 9.)

Production of Brood Stock

Palmetto bass, sunshine bass, and Virginia bass are relatively easy to culture to adults in ponds. Under optimum conditions, males often mature at age 1 and both sexes are mature and can be successfully spawned at age 2. Maturation appears to be more a function of size than of age. Females begin to mature at about 1.0-1.5 pounds and males at about 0.7 pounds (J. H. Kerby, unpublished data). To date, our experience indicates that the hybrids are easier to spawn and provide more consistent results than are provided by female striped bass that have been reared in ponds.

Although F_2 hybrids are not good candidates for aquaculture, backcrosses of F_1 hybrids to striped bass may provide a suitable alternative to F_1 hybrids, judging from results of a preliminary study by Kerby (1987b). Because female F_1 hybrids can mature in 2 years, are relatively easy to artificially spawn, and are better able than female striped bass to recover from the stress of artificial spawning, their use as "domesticated" brood stock would be an advantage if the progeny show the vigor and growth rates of the F_1 parents.

White bass can also be reared for brood stock, and wild fish can be acclimated to culture conditions, particularly if live forage is provided. Although techniques have not been well developed or described, we believe that they will not differ significantly from those used for hybrids produced with non-striped bass females.

In general, brood stock should be reared as described for phase III fish. However, it is probably advisable to select the larger phase II fingerlings for culture to brood stock, and stocking rates should be lower (perhaps initially on the order of 1,000 fish/acre). It is advisable to cull or transfer fish as they grow so that total biomass in a brood stock pond does not exceed 1,000 pounds/acre. Because domesticated brood stock are so valuable, we highly recommend that a pond aeration system or the capability of flushing fresh water through the pond be available. A single oxygen "crash" can destroy years of work.

Although striped bass that have been fed exclusively with an artificial trout diet have been reared and spawned in captivity (L. C. Woods III, Baltimore Gas and Electric Company, personal communication), we recommend that the diet be changed to a high quality salmon diet as the fish mature, particularly by early fall, if they are to be spawned in the spring. It may also be advantageous to supplement the commercial diet with live, fresh, or frozen fish. We emphasize that, although it has been demonstrated that hybrid striped bass can be reared and spawned rather easily, their usefulness as brood stock has not been fully demonstrated.

Commercial Potential

In the late 1970s, when it became apparent that commercially exploited striped bass populations were declining and their commercial value was increasing, interest in culturing striped bass as a commercial food fish began to develop. Interest soon focused on hybrid striped bass because of their hardiness and fast growth rate. In 1982, at a special symposium on culture of marine finfish held at the annual meeting of the World Mariculture Society in Charleston, South Carolina, Kerby et al. (1983a) described culture techniques for striped bass and hybrids and included preliminary data on the commercial potential of hybrid striped bass. The interest generated at that meeting, and from presentations at a later meeting in Washington D. C. in 1983 (Kerby et al. 1983b; Woods et al. 1983), coupled with a net pen study by Williams et al. (1981), has continued and dramatically increased in the intervening years. As a result, more than eight million hybrid fingerlings were produced by private producers in 1989 and provided to other growers for commercial production of food fish. Although this new industry is still in its infancy, it appears that it could soon rival the farm-raised catfish industry.

The striped bass is an excellent food fish that has traditionally been an important, high-value commercial product along the Atlantic coast. Wholesale prices have ranged as high as U.S. \$4/pound for fish in the round (Kerby et al. 1983a; Carlberg et al. 1984), and live striped bass have been sold for \$6/pound in New York and California (Swartz 1984; Carlberg and Van Olst 1987). Recent marketing trials (Huish et al. 1987; T. I. J. Smith, South Carolina Resources Research Institute, personal communication) and surveys of fresh-fish wholesalers (Carlberg and Van Olst 1987) have demonstrated that striped bass hybrids are also considered a high-value food fish that can be sold for \$2-4/pound in the round to wholesale markets.

Research by several investigators during the past 10 years (Williams et al. 1981; Kerby et al. 1983a,b, 1987a; Woods et al. 1983, 1985a; Kerby 1986; Huish et al. 1987; Smith et al. 1985, 1989; Jenkins et al. 1989) has adequately demonstrated the potential of hybrid striped bass for commercial culture. Kerby et al. (1983b), by producing over 4,000 pounds/acre in earthen ponds, first demonstrated that hybrid striped bass could be grown to marketable sizes in commercial quantities within 15 to 18 months after hatching. Climate and length of growing season, of course, affect the sizes that are attained. Smith et al. (1985) showed that hybrid striped bass could be cultured intensively under controlled conditions to weights over 1.5 pounds in less than a year, and a yield at harvest of 2.7 pounds/cubic foot. In later studies, Kerby et al. (1987a) and Smith et al. (1989) demonstrated that semi-intensive pond production of hybrids can range from 5,000 to over 7,000 pounds/acre if adequate water quality is maintained.

An added advantage of hybrid striped bass is that they can be cultured in a wide variety of salinities, ranging from fresh water to about 30 ppt salinity (Kerby and Joseph 1979; Williams et al. 1981; Woods et al. 1983; Smith et al. 1988). Other studies suggested that hybrids preferred saline water (Kerby et al. 1971; Yeager 1985) and that they could tolerate rapid changes from fresh water to 36 ppt or vice versa (Wattendorf and Shafland 1982). However, personal experience has shown that, although hybrid striped bass can adapt to water with low hardness and alkalinity, they are easily stressed. In our opinion, culture water with alkalinities ranging from 150-300 ppm (as CaCO_3) is preferable to water with lower alkalinities. Thus, we recommend that water quality be carefully considered when a farm location is considered.

Hybrid striped bass also have the advantage of being more temperature tolerant than striped bass, which allows effective culture in a wider geographical area. Although the optimum culture temperature for striped bass appears to be about 75°F (Cox and Coutant 1981), hybrid striped bass appear to grow better at higher temperatures, the optimum probably being near 80-82°F (Kerby et al. 1987a; Woiwode and Adelman 1984; Woiwode 1989). This is a particularly useful characteristic in the more southern and southwestern states, where summer temperatures normally reach or exceed this level.

The information developed by researchers is now being put to use and new fish farms are being constructed with the express purpose of farming hybrid striped bass. In 1987, Aquatic Systems, Inc., a tank culture operation on the west coast, marketed the first significant commercial crop, with production of 335,000 pounds (Van Olst and Carlberg 1990). In September 1988, as the result of a joint project of the U.S. Department of Agriculture, a private Maryland farmer,

and the University of Maryland, a privately produced commercial crop of pond-reared hybrid striped bass was harvested. Production exceeded 4,000 pounds/acre. The fish were provided to Virginia Polytechnic Institute and State University, where marketing and product development studies were conducted (D. W. Webster, University of Maryland Sea Grant Extension Program, personal communication). Later that year, another commercial crop of pond-reared hybrids was harvested and sold as a result of a cooperative project between North Carolina State University and a private producer. Commercial operations in several states are expected to produce their first crops in 1990.

Market prices, like those of any commodity, are expected to follow the law of supply and demand. As a product becomes more readily available, prices will undoubtedly fall. However, with a little foresight, hybrid striped bass farmers can learn and profit from the lessons catfish farmers have already learned — i.e., that new markets must be continuously developed to ensure continued expansion. If these lessons are learned, we believe that this new aquaculture industry, developed primarily on striped bass hybrids, has the potential to rival the farm-raised catfish industry.

Genetic Manipulations

Hybridization is a basic type of genetic manipulation in which traits of two or more parental species are combined in the hybrid progeny. Since various aspects of *Morone* hybridization have already been discussed earlier in this chapter, they are not repeated here. Instead, we discuss techniques that may ultimately be useful in producing or improving characteristics (such as increased viability, growth, and production) desirable to fish culturists or management biologists. Unfortunately, not enough information is available to evaluate their merit. In our discussion, we assume that the reader has some basic knowledge of the cellular processes that occur in the reproductive process.

Polyploidy

Normally organisms are diploid (2N), that is, they have two complete sets of chromosomes that are replicated in each body cell. One set is contributed by each parent. In recent years, the production of polyploid fish (containing one or more additional sets of chromosomes) has been examined as a biotechnological tool for increasing production and for certain management purposes. For example, triploid grass carp (*Ctenopharyngodon idella*) containing three sets of chromosomes are now produced and used routinely for biological control of aquatic vegetation. Triploids are used because they are believed to be functionally sterile (Thompson et al. 1987; Goudie 1988). Although most previous work has been done with salmonids, scientists are increasingly investigating the potential of polyploidy in other species.

Polyploidy in fish can be produced by "shocking" normally fertilized eggs at certain stages to produce triploids, which have three sets of chromosomes (3N), or tetraploids, with four sets of chromosomes (4N). The shock is typically either thermal (cold or heat) or hydrostatic pressure. Triploidy is induced by applying the shock soon after fertilization to effect retention of the second polar body. Tetraploidy is induced by applying the shock some-

what later in the development process to effect either karyokinesis (separation of chromatids) or cytokinesis (endomitosis, or prevention of cell division) at first cell cleavage.

Triploids are of particular interest because studies with other species indicate that they sometimes have significantly better survival, growth rates, and feed conversion than their diploid counterparts (Wolters et al. 1982; Beck and Biggers 1982; Scheerer and Thorgaard 1983; Parsons et al. 1986). Evidence increasingly indicates that this phenomenon is often not observed until the onset of sexual maturity, which suggests that metabolic energy normally used for development of gonads, sex products, and reproduction may instead be used for growth.

Viable tetraploids have been more difficult to produce in fish, being much less hardy than their diploid counterparts (Chourrout et al. 1986; Cassani et al. 1990). However, at least in one instance, tetraploid rainbow trout (*Oncorhynchus mykiss*) have been successfully reared and spawned (Chourrout et al. 1986). Successful rearing and spawning of tetraploids with normal diploids could be a method of circumventing *de novo* triploid induction, which may result in increased survival and virtually 100% production of tetraploids.

There is high interest among fishery biologists in the potential of triploidy. Because striped bass hybrids are fertile, many natural resource managers are concerned that backcrossing may have significant effects on the gene pools of the parental species as a result of introgression (the incorporation of some genes from one species onto the genetic background of another species). This concern has caused hesitation by resource managers in allowing the production of hybrids in some states or in drainages containing striped bass spawning runs. If hybrid triploids are sterile, they will be more acceptable to fishery biologists for aquaculture and for stocking in natural waters for recreational and management purposes.

Triploidy was first induced in hybrid striped bass in 1984 at the Moncks Corner, South Carolina striped bass hatchery (Kerby 1987), with further refinements in 1985 by Curtis et al. (1988) which included tetraploid induction. Experiments with thermal shocks of 37-41°C in 1984-1986 produced up to 95% triploidy in SB x WB (Kerby et al. 1989), but results were very inconsistent, and the combinations of temperature and treatment variables that resulted in the highest percentages of triploids often resulted in the greatest egg and embryo mortality.

In experiments in 1987-88, hydrostatic shock was used (as an alternative to temperature shock) to effect triploid induction in palmetto and sunshine bass. Techniques and equipment were based on those developed by Cassani and Caton (1986) for grass carp. Results were more consistent than for temperature shock, with triploid induction ranging as high as 100%, and there was increased survival to hatch; however, significant numbers of fry were sometimes deformed (Kerby 1988).

Triploids can be readily verified by using a flow cytometer or Coulter counter (Allen and Stanley 1983; Wattendorf 1986). A flow cytometric technique, in which nuclear suspensions prepared from larvae after hatching are used, was developed at North Carolina State University (J. M. Hinshaw, J. H. Kerby, and M. T. Huish, unpublished data); it allows determination of the ploidy state of individual larvae, or approximate percentages of triploids in groups of larvae.

The method enables estimates of percentages of triploids in groups of larvae before stocking. The groups with low percentages of triploids can be discarded or used for other purposes. The procedure is provided later. A somewhat similar method has recently been developed for use with the Coulter counter (J. R. Cassani, Lee County Hyacinth Control District, Florida, personal communication).

Technique for triploid induction. Currently, hydrostatic pressure appears to be the most efficient method of producing triploids in the genus *Morone*. The technique given here has produced the best overall results, but results are often highly variable in terms of both percentages of triploid induction and percentages of normal, viable larvae. Further work needs to be done to refine the technique.

Because timing is important in administration of the shock treatment, it is important to know when spermatozoa are activated (by adding water) and the fertilization process is initiated. Eggs are stripped from ripe females and semen is added concurrently with hatchery water to fertilize them. Approximately 2.5-3 minutes after the fertilization process begins, most of the water is decanted and the fertilized eggs are poured into the pressure chamber (Figure 11.9). The chamber should be filled almost to the top with fertilized eggs and water. Insert

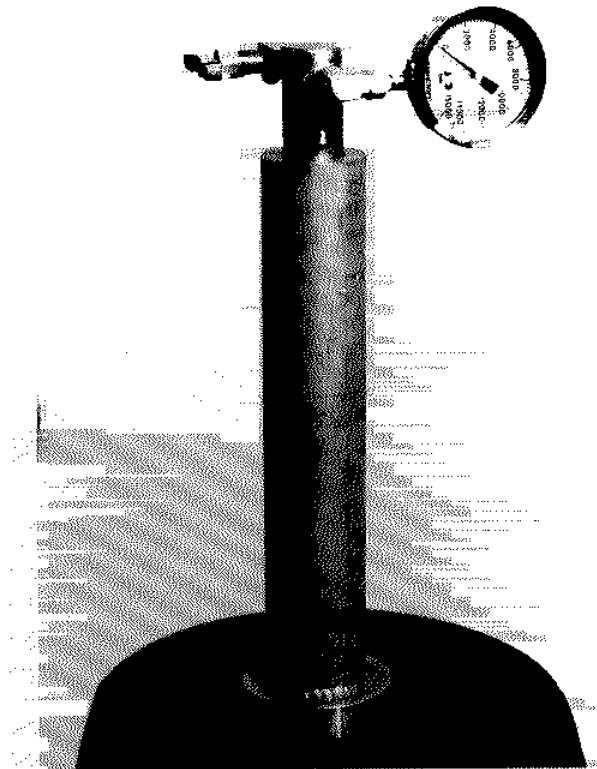

Figure 11.9. Pressure chamber used to induce triploidy in striped bass and hybrid striped bass. Photo Credit: Monte Stuckey.

the plunger, open the air release valve, and push the plunger into the chamber until all air is forced out and a small amount of water is expelled from the valve. Close the valve and position it on the hydraulic press. A 17- to 20-ton shop press should be adequate if pressures do not exceed 10,000 psi (pounds per square inch) inside the chamber. Four minutes after fertilization, the pressure in the chamber should be brought to 8,000 psi as rapidly as possible. This normally requires 6 to 10 seconds. Release the pressure 1.5 minutes after pressurization. Place the treated eggs in hatching jars and incubate according to standard practice. At least one lot of eggs from each female (or group, if eggs from several females are combined) should always be left untreated so that fertilization and hatch percentages can be compared. If fertilized eggs from females other than striped bass are used, treatment with the salt-urea solution should begin during the pressure treatment to alleviate adhesion problems.

Increasing the treatment pressure to 9,000 or 10,000 psi can yield higher percentages of triploid larvae, but these pressures also reduce survival to hatch and increase the numbers of deformed fry. Incubation facilities should be arranged so that larvae from individual treatment and control groups are kept separate after hatch until ploidy analyses can be performed. Group samples of 50 or 100 larvae from each treated lot should be prepared for flow cytometric analysis within 24-48 hours after hatch. This will allow time to ship the samples to an appropriate facility for analysis before the larvae must be stocked.

Procedure for determining ploidy of fish larvae when flow cytometry is used. The ploidy state of individual larvae, or approximate percentages of triploids in batch samples of larvae, from one to a few days of age can be determined by a flow cytometer to measure DNA content in cell nuclei. The directions follow.

Prepare the following solutions:

1. *Chicken Red Blood Cell (CRBC) Standard:*

Reconstitute glutaraldehyde-stabilized CRBCs (i.e., Sigma # R 4875 or R 5503) as per instructions on the vial. Hematall^R (an isotonic saline manufactured by Fisher Scientific) can be used as the diluent.

2. *Propidium Iodide (PI) Solution:*

Nonidet P-40	12 mL
RNA-se	10 mg
Propidium Iodide	50 mg

Bring the solution to 1 L with Hematall. It should be refrigerated and protected from light. If desired, it can be prepared and stored frozen in quantities required until needed. (Propidium iodide is a hazardous material and must be handled with extreme care. Read label directions carefully.)

Preparing samples for the flow cytometer:

1. *Individual Larvae:*

- a. Place each larva into a vial containing 0.5 mL of the PI medium. Be sure to use vials compatible with the flow cytometer or plan to transfer samples to appropriate vials before running them. Place the vials in a refrigerator and store them at 1-5°C for 12 to 24 hours. Keep PI solution and samples in darkness except when being used.
- b. Put a 20- to 23-gauge needle on a disposable hypodermic syringe, draw the larva into the syringe repeatedly to effectively break up the tissues. Then change to a 27- or 28-gauge needle and repeat the process.

If the larvae are small — e.g., *Morone* spp., 2-5 mm long — this is probably the only preparation required before running the sample on the flow cytometer. Be sure to use clean syringes and needles for each sample to avoid contamination with cells from previous samples. If the larvae are large (e.g., rainbow trout larvae), each sample should be further treated as described below for batch samples.

2. *Batch Samples of Larvae:*

- a. Count samples of 50 or 100 randomly selected larvae into vials containing 2 mL of PI solution. Place the vials in a refrigerator and store them at 1-5°C for 12 to 24 hours. Keep PI solution and samples in darkness except when being used.
- b. Using 18- to 23-gauge needles, draw the larvae into the syringe repeatedly to effectively break up the tissues. Numbers and gauges of needles necessary will depend on the size of the larvae in the sample. Then change to a 27- or 28-gauge needle and repeat the process.
- c. Force each sample through a 37- μ m filter placed in a Gelman syringe filter holder to remove the remaining pieces of tissue. Fresh PI solution can be added to bring the total volume back to about 2 mL.
- d. The samples should then be allowed to "settle" for at least 1 to 2 hours. During this period, oil from the oil globules and yolk sac rises to the surface. The oil should be aspirated off with a vacuum aspirator, so that it will not cause clogging when samples are run in the flow cytometer.

3. *Chicken Red Blood Cells:*

After shaking the vial thoroughly, place a *small* drop of CRBCs in a vial containing 2 mL of the PI solution. Although CRBCs fixed in glutaraldehyde fluoresce without

further treatment, and are often used as standards by which flow cytometers are calibrated, they take on additional fluorescence if placed in PI solution. Thus, this step is particularly important if CRBCs are to be used as an internal standard.

4. *Diploid Standard:*

Whether analyzing single or batch larval samples, two or more known "standard" samples containing known diploid larvae should be prepared for use in calibrating the flow cytometer. The standards should be prepared in the same way that the samples to be analyzed were prepared, and at the same time as the samples to be analyzed.

5. *Flow Cytometer Analysis:*

- a. Nuclear suspensions prepared according to the above directions can be analyzed by using a Becton-Dickenson FACS-440 flow cytometer set at 488 nm with a DF 575/26 filter. For individual larval samples, 10,000 nuclei (events) are normally analyzed for DNA content; 20,000 nuclei are normally analyzed for group samples.
- b. For ease in making calculations, the flow cytometer can be calibrated at channel 50 for diploids. Triploid fluorescence then falls somewhere near channel 75 (50×1.5).

The numbers of nuclei contained within a 95% confidence interval around the mean fluorescence peaks can be used to reliably estimate the ploidy percentages in batch samples. Software for the cytometer's computer should provide computation of 95% confidence intervals or approximations thereof. It should be recognized that fluorescence peaks for larval samples will be broader and more variable than those for blood samples. This is probably due to the greater variety of cell types from whole body tissue.

6. *Correction Factor:*

A correction factor is needed to accurately estimate the percentages of triploids in larval samples. Previous work has shown that percentages of triploid larval fish estimated from the group samples are consistently lower than those derived by using individual fish samples. Estimates of triploids in group samples averaged about 66% of the actual percentage of triploid fish, as determined from samples of individual fish. To obtain an accurate estimate of the percentage of triploid fish in group samples, an adjustment of 1.5 multiplied by the number of triploid nuclei was required. A convenient formula for making the final estimate follows:

$$\text{Percent Triploids} = \frac{N_t \times 1.5}{N_d + (N_t \times 1.5)}, \text{ where}$$

N_t = number of triploid nuclei

N_d = number of diploid nuclei

Gynogens

Gynogens are organisms that have two sets of chromosomes, both of which are derived from the female parent. They are normally produced by fertilizing eggs with sperm in which the male genome has been destroyed (usually by some type of irradiation) and by effecting retention of the second polar body.

Reproduction of gynogens represents another method that might increase production, and that might eventually reduce some other production problems as well. Gynogenetic offspring from F_1 hybrids showing the fastest growth rates would contain the same genetic material as the female. However, fusion of the female pronucleus with the second polar body produces a zygote with sister chromosomes and results in homozygosity for all gene pairs except those involved in any previous crossovers between homologous chromosomes. Thus, excluding crossover potential, offspring from artificial gynogenesis would probably be homozygous for most gene pairs.

Artificial gynogenesis might eventually allow continuous production of F_1 hybrids from hybrid brood stock, which would alleviate the need to acquire or maintain two different parental stocks. Additionally, artificial gynogenesis may be useful in selective breeding since homozygosity can be effected in fewer generations than with inbreeding. Clones have been produced in zebra fish (*Brachydanio rerio*) by Streisinger et al. (1981) and common carp (*Cyprinus carpio*) by Nagy et al. (1983).

Homozygosity can also result in an expression of lethal recessive traits, but second generation gynogenomes are likely to be purged of most lethal genes. For example, only 20% of the gynogenomes in the first generation of zebra fish survived to maturity, but 68% survived in the second generation (Streisinger et al. 1981). Different clones also differed in viability, longevity, and fecundity, but more vigorous "hybrids" could be produced by sex-reversing individuals to functional males and crossing two clones of homozygous individuals. Gynogens have been artificially produced in a number of other fish species including grass carp, channel catfish (*Ictalurus punctatus*), and various salmonids (Stanley 1976; Chourrout 1984; C. Goudie, U.S. Department of Agriculture, Catfish Genetics Research Unit, personal communication).

Little effort has been made to develop gynogens for the purposes just described. We produced putative gynogen striped bass by irradiating spermatozoa from white bass with ultraviolet light and heat-shocking the fertilized eggs at various temperatures. However, because rearing facilities were limited, we were unable to confirm the production of gynogens. Because gynogens have a normal chromosome complement, it is necessary to rear larvae created with attenuated sperm from a different species to a stage that they can be morphologically or

biochemically identified as a pure species or a hybrid. The only other option is to use fish with a prominent genetic marker, such as albinism in channel catfish.

Gene Pool Conservation and Exotic Fishes

Two topics which have come to the forefront in recent management decisions pertain to conserving gene pools of managed species and the introduction of exotic species. We discuss some of the implications of these subjects in reference to striped bass.

Management Concerns

In recent years, management biologists have become increasingly concerned with the long-term survival and viability of the striped bass stocks they are managing. The decline of striped bass populations in coastal rivers and bays has caused concern, not only over the general health of these populations, but over their genetic health as well. Considerable time, effort, and money have been spent to manage and protect striped bass stocks in an effort to insure their survival. As a result, biologists managing inland stocks have become more aware of the possible dangers of inbreeding, and some states have adopted genome conservation programs (e.g., South Carolina and Maryland).

Conservation genetics is a relatively new field in fisheries management. Its initial foundations were built on efforts to save endangered and threatened species, and the principles are now being applied to species "in need of conservation," as well as to healthy populations. Frankel and Soulé (1981) stated that if a given recovery effort does not have a genetic basis, long-term conservation will most likely fail. Thus, the importance of considering genetics in any effort to enhance or restore existing populations, or to establish a new population, cannot be sufficiently emphasized. The importance of conservation genetics in fisheries management was stressed by Meffe (1986); many of his arguments follow. Although he was primarily interested in the conservation of endangered species, the concepts he discussed apply to all managed populations, and should be reviewed by both management and hatchery biologists before a stocking program is developed.

Within a given population, size (number of individuals) is the most important factor contributing to the maintenance of high genetic variability (Frankel and Soulé 1981). Size is not defined simply as the census, but as the effective population size, because many individuals may be immature, or may contribute disproportionately to future generations.

The effective population size (N_e) is related to the inbreeding of a population as it deviates from an idealized population structure (Falconer 1981, p. 48, described an idealized population). He defined effective population size as the number of individuals that give rise to the calculated rate of inbreeding (sampling variance) if a population is bred in the manner of an idealized population. Therefore, as N_e decreases, the rate of inbreeding increases. N_e is nearly always less than N and is influenced by the total number of breeding individuals, sex ratio, mating system, contribution of offspring, variance in family size, and population fluctuations —

e.g., low survival of a given year class (Meffe 1986; Tave 1986). It must be kept in mind that the generation time for most striped bass is at least 5 years.

According to Frankel and Soulé (1981), N_e can be determined as

$$N_e = \frac{4 N_m N_f}{N_m + N_f}, \text{ where}$$

N_m = number of breeding males

N_f = number of breeding females

As an example of a reasonably good N_e , assume a wild population has 200 mature brood stock of equal numbers (100 males and 100 females) using the formula, the effective population would then equal 200. Conversely, in a hatchery situation where a limited number of females and males are used to meet production needs (i.e., 4 males and 2 females) the effective population size is only 2.6 which is less than half of the actual population size.

It is easy to see that as a reproducing population deviates from a sex ratio of 1:1, the value of N_e will decrease. Other factors, such as progeny distribution (number of offspring contributed per family) and population fluctuations (low survival of a given year class) can act to further lower N_e (Meffe 1986).

The loss of genetic variance can have three major effects: increased homozygosity (which may lead to reduced fitness), loss of additive variance, and an increase in deleterious recessive alleles. Rare alleles are generally neutral or contribute little to the overall genetic health (or variance) of a population; however, they may at certain times be extremely important to the survivability of the population. Increased homozygosity for specific low-frequency alleles in a population is usually accompanied by a reduction in overall fitness. This reduction can lead to future fixation of higher-frequency alleles, thus further reducing variability (losing heterozygosity). This reduction can result in higher disease susceptibility, reduction in fecundity or gamete viability, and lower tolerance to ecological perturbations.

In dealing with the impacts of hatchery fish, one really does not need to utilize an analysis of effective population size because problems may occur well before this level (mature stocks) is reached. A more important question, which can be exclusive of mean population numbers, has to do with the impact of hatchery fish on genetic variability. For example, assume a hypothetical river system which is stable at 10,000 breeding pairs of fish with constant replacement with frequency of $p = 0.5$, $q = 0.5$ at a codominant autosomal locus. Through Hardy-Weinberg equilibrium, the distribution of genotypes would be:

AA — 5,000 fish

AB — 10,000 fish

BB — 5,000 fish

Add to that river 100,000 hatchery fish (50:50 sex ratio) produced from one pair of fish all monomorphic at that locus (i.e., $p = 1.0$). If there is 10% mortality, and 90,000 fish (45,000 breeding pairs) enter into the population of 10,000 naturally breeding pairs and panmixis is present in the modified population, the genotype distribution would now equal:

$$\begin{aligned} AA &— 5,000 \text{ native fish} + 90,000 \text{ introduced} = 95,000 \\ AB &— 10,000 \text{ native fish} + 0 = 10,000 \\ BB &— 5,000 \text{ native fish} + 0 = 5,000 \\ p &— 90,000 + 5,000 / 105,000 = 0.905 \\ q &— 5,000 + 5,000 / 105,000 = 0.095 \end{aligned}$$

Now assume that 50,000 breeding pairs remain for the next year; the population structure would then be:

$$\begin{aligned} AA &— 81,903 \text{ fish} \\ AB &— 17,195 \text{ fish} \\ BB &— 902 \text{ fish} \end{aligned}$$

Thus the locus would be almost completely fixed. Obviously this presents a very simple analysis, but more extreme effects could occur when more loci are considered as well as age structure (R. P. Morgan, II, University of Maryland, personal communication).

Given these concerns, if management biologists wish to consider the long-term genetic health of a population, they should take every possible step to prevent any reduction in variability. To accomplish the task of maintaining variability, biologists should consider the use of size limits (both maximum and minimum) for the catch, closed seasons, reduced creel limits, and possibly stock enhancement with hatchery-reared fish to offset population declines. All management decisions should be based on considerations designed to protect each year class long enough to allow its gene pool to be passed on proportionately to future generations.

Hatchery Considerations

Because technological breakthroughs have allowed consistent production of large numbers of fingerlings, hatchery stocks have been used to establish and maintain inland striped bass populations and to enhance coastal populations. However, it is important to remember that hatchery-reared fish represent only a management tool and should be used as one. Serious genetic problems can result from the use of cultured fish if current hatchery practices continue and there are only a few instances where genetics is an integral part of a hatchery operation.

Typically, a striped bass hatchery is operated for a short time each year during the spawning season. Because the operation is expensive and extremely labor intensive, the economics of operation must be considered. If a few good females are spawned, the annual production for a hatchery can usually be met rather easily. This means that less time is consumed in the hatchery, and more time is available for improving fingerling production.

Because female striped bass average about 100,000 eggs per pound of body weight, it is easy to see that, if only 1 or 2 million fry are needed for stocking ponds, only a few females are needed. This is where genetic problems can develop. Historically, a few states, notably South Carolina, North Carolina, Virginia, Georgia, Tennessee, and, most recently, Maryland, have produced most of the fry that have been stocked in the U.S. With few exceptions, the annual stocking of fingerlings in individual coastal river systems have been the progeny of five or fewer females. Over the past few years, an average of only four females were used annually to produce all the fingerlings stocked in Georgia's coastal rivers (R. E. Rees, Georgia Department of Natural Resources, personal communication). A similar number of females of South Carolina origin was used to produce fingerlings for enhancement of populations in Albermarle Sound, North Carolina, and the Santee River, South Carolina. Each female was normally fertilized with two males (R. M. Harrell, unpublished data).

In genetic terms, this information translates to a tremendous potential for inbreeding and reduced population fitness. The use of so few brood fish results in an inordinately low effective population size or genetic variability for the hatchery produced progeny. The impact of a hatchery stock on the gene pool of a native population is difficult to measure, and depends on many factors. The relative contribution of the hatchery fish to the total population is, of course, one of the more important factors. If the hatchery progeny later composes a sizable proportion of a specific year class, the genetic influence can be significant as evidenced in the example mentioned above. Unfortunately, little historical information is available on natural production in the river systems where these fish were stocked, so it is hard to predict the genetic influence of hatchery-produced fish in these systems. Even so, the impact of hatchery releases on natural stocks can be stated to be most severe when hatchery fish are more numerous than wild fish of the same age.

An example of the potential problem can be found in information available from South Carolina. For a period of 5 years, the South Carolina Department of Wildlife and Marine Resources attempted to enhance the native striped bass population in the Santee River by stocking hatchery-reared fish (Harrell 1982, 1983). During this period, recruitment estimates were obtained by using the hatchery fish as a marked population. Each year, 100,000 phase I and 100,000 phase II fish were stocked and used to estimate recruitment (phase I), attrition rates (phase I), and hatchery contribution to the population (phases I and II). Because of a high attrition rate during the summer, the contribution of phase II hatchery fish to the fall population (native and phase I fish) exceeded 50% for three of the five years. Conservatively, one of two young-of-the-year fish were contributed from less than four females each year, and it is possible that the majority of these fish were half-siblings.

Another factor that must be considered in using hatchery-produced fish for stock enhancement or restoration is strain integrity. The Chesapeake Bay striped bass stocks provide a good example. These fish have evolved to allow the strain to spawn successfully in tidally influenced estuaries, which include short tributaries. They produce characteristic eggs with a large oil globule, which allows them to remain in the water column during slack tide, moving back and forth with the tide. If a strain that lacks this characteristic were introduced, the eggs

without the large oil globule probably would not survive. Furthermore, introduced fish are likely to spawn with Chesapeake fish, which might reduce the reproductive capacity of the progeny. Integration of allopatric populations with these stocks could dilute this unique gene pool. It is important to retain, as closely as possible, the genetic integrity of the native population in a system by introducing hatchery fish with a similar genetic background and as much genetic variation as economics may allow. Obviously, the introduction of completely foreign genomes may sometimes occur as the result of a conscious decision by resource managers who wish to exploit particular traits inherent in the introduced fish.

If genetic integrity of a stock is to be maintained, managers should seriously consider eliminating the practice of stocking phase II fish into naturally reproducing populations. Although reasons often cited for stocking a fish large enough to receive a proper mark (tag) to identify it as a hatchery-produced fish are valid, the potential loss of genetic diversity as a result of stocking these fish may be considerably greater than the benefit gained from tagging them. Artificial selection constantly occurs in a hatchery environment because circumstances, as well as biologists, consistently select for fish that adapt to hatchery conditions and artificial food. The loss of genetic variability in hatchery-reared fish is exacerbated when they are kept in an artificial environment (i.e., culture pond or tank).

Hatchery managers can improve genetic variability by increasing the effective population size in their hatchery. This can be done by increasing the number of both males and females used during the hatchery season. Ideally, an equal number of males and females should be used, but because a single female can produce hundreds of thousands of eggs, genetic variability can be increased to some extent by dividing the eggs from each female into several containers and fertilizing each aliquot with different males. Males should be used only once to fertilize a portion of the eggs from a single female. It would also help improve diversity if larvae from several females were pooled and stocked into individual ponds, instead of progeny from a single female being stocked in one or two ponds. Granted, this will add to the record-keeping confusion with respect to production, but if hatchery-reared fish continue to be used to enhance naturally reproducing populations, the long-term results may be well worth the extra effort required.

It may sometimes be necessary to preserve a stock by using a small number of brood fish (i.e., small effective population size). In such situations, the loss of a unique genome may be the overriding factor that rules out the ability to increase genetic variability, but one must weigh the consequences of no action — that of possible extinction.

In summary, management biologists, and to a lesser extent hatchery biologists, are largely at the mercy of nature in their attempts to maintain a population within the goals they have set. If managers base their decisions on the knowledge that short-term success can lead to long-term failure if genetic considerations are not an integral part of the management scheme, efforts to restore or enhance striped bass populations are more likely to be successful.

Special Considerations in the Culture of Striped Bass and Striped Bass Hybrids

Nick C. Parker, Gerald T. Klar, Theodore I. J. Smith,
and Jerome Howard Kerby

Striped bass (*Morone saxatilis*) and its hybrid striped bass produced in state and federal hatcheries are normally reared in static earthen or vinyl-lined ponds using techniques common for other warmwater species (Dupree and Huner 1984). However, increased demand for fish by both public and private sectors has stimulated interest in improving production efficiency through a variety of techniques, including semi-intensive production involving supplemental aeration. Efforts have also focused on techniques to reduce stress to improve survival of fish during all phases of rearing, as well as during and after transport. Research on techniques to produce progeny from controlled spawning of domesticated brood stock and through the use of cryopreserved sperm are on-going. We describe some special culture techniques now in use in some facilities involved in semi-intensive and intensive culture of the striped bass and its hybrids

Aeration and Oxygenation

Dissolved oxygen (DO) concentrations in striped bass rearing ponds may decline below desirable levels for several reasons: dense phytoplankton blooms; high organic loading; high fish biomass; cloudy, still weather; and others. At these times, supplemental or emergency aeration may be necessary to insure adequate DO levels for fish survival.

There are two approaches to artificial pond aeration. Emergency aerators, which are relatively portable devices that can be moved from pond to pond as needed, are often used. Secondly, continuous aeration or pond circulation can be provided through the use of permanently installed devices such as axial flow pumps, submerged fans, paddle wheels, airlift pumps, air diffusers, oxygen generators, and liquid oxygen injection systems.

Circulation of pond water has proven beneficial, not only in striped bass ponds (Parker 1980, Parker et al. 1984), but also in catfish and shrimp ponds (Busch 1980; Busch and Goodman 1983; Rogers and Fast 1988). Mixing surface and bottom layers of water reduced thermal stratification and increased levels of DO at the pond bottom in all of these studies. Many of the

supplemental aeration systems can be commercially purchased, so with the exception of airlift systems, are not described in detail here. We next discuss inherent advantages and disadvantages, and other information, on each system.

Airlift Pumps

Parker (1980) reported that fingerling striped bass production was 2.4 times greater in ponds aerated continuously with airlift pumps than in 0.1-acre ponds without aeration. Continuously operated airlift pumps appear to maintain uniform temperatures and DO throughout the pond by continuously circulating the water, which results in mixing oxygen-rich surface water with oxygen-deficient bottom water (Figure 12.1). Air injected into water with an airlift pump adds very little oxygen to a pond compared with oxygen diffusion at the air-water interface. Oxygen produced by photosynthesis in the upper layer of the water column is uniformly distributed throughout the pond by airlift pumps, which serve to alleviate potentially dangerous levels of gas supersaturation common in pond surface water in the afternoon and low levels of DO in the morning (Parker et al. 1984). Emergency aeration may still be required during prolonged periods of cloudy weather or if pond vegetation is dense. Another advantage of this type of aeration is that it can be supplied in the culture of phase I fish (about 1-2.5 inches long) with little risk of damage to larvae and small fish. Water velocities in airlift pumps are low, and any fish that might be entrained are gently moved through the pumps. A negative concern is that operation of continuous aeration systems in ponds with large accumulations of

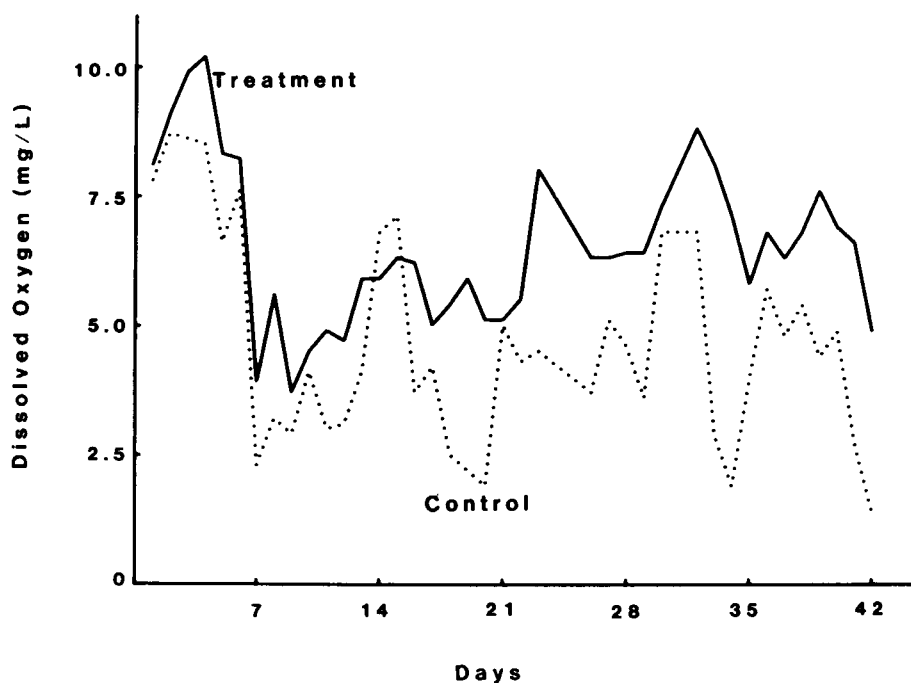

Figure 12.1. Concentration of dissolved oxygen at the bottom of striped bass production ponds equipped with airlift pumps to circulate water (treatment) and in ponds without water circulation (control).

organic matter on the pond bottom may actually reduce the average level of DO. This reduction in DO results from oxygenated surface water moving to the bottom of the pond, where oxygen is used to oxidize accumulated organic materials. To alleviate this situation, ponds should be drained, dried, and disked to oxidize organic deposits before they are filled, and frequent aeration procedures should later be used (see Chapters 8 and 9). Ideally, organic material added daily would be oxidized daily and no oxygen deficient accumulations would occur.

An airlift system consists of a blower, an air distribution line, and an airlift pump. Blowers deliver large volumes of low-pressure air and may be of the rotary vane or regenerative type (see Figure 6.2). A 1-kW blower will supply enough air to operate 25 airlifts in a 2.5-acre pond at a cost of about \$1.25 per day, based on US \$0.07/kW-h. The blower may be installed on the pond bank or in a central location so it can supply several ponds. Protection of the blower from weather is desirable.

A wide variety of materials are suitable for air distribution lines since the operating pressure is usually about 1 psi. Rigid polyethylene or polyvinyl chloride (PVC) pipe may be permanently installed underground, or fiber-reinforced polyethylene pipe may be installed at the surface, to supply air to the airlift pumps. Air lines in excess of 100 feet should be at least 4 inches (and preferably 6 inches) in diameter to reduce friction and prevent excessive back pressure on the blower. Thin-walled, 6-inch diameter PVC pipe buried just beneath the surface makes an excellent main line for an air distribution system. A standard 6-inch glue-on coupling is placed at each airlift location. A hole is drilled into the side of the coupling and tapped to receive a 0.5-inch national pipe thread (NPT) fitting. A 0.5-inch PVC valve is attached to the tapped hole with a length of PVC pipe sufficient to place the valve above the surface of the ground. Air is transferred through 0.5-inch flexible polyethylene tubing from the valve to the airlift pump. The valve is adjusted (or a small plate with a 1/8- to 1/4-inch orifice is fitted inside the 0.5-inch tubing) to maintain a minimum of 30-32 inches of water pressure (1.08-1.16 psi) in the main air distribution line; this insures even delivery of air to all pumps, even if they are not uniformly submerged in water.

Airlift pumps, which may be purchased commercially or constructed from readily available materials, consist of a vertical PVC pipe with a 90° elbow at the water surface (Figures 12.2 and 12.3). Air is injected into the vertical pipe 24 inches below the water surface. The air-water mixture becomes lighter than water, rises, and is discharged through the elbow at the water surface. The elbow directs the water flow horizontally across the pond. The pivot point (Item 8, Figure 12.3), may be adjusted to match pond depth. The pump holder, a floating bracket (Item 6, Figure 12.3) then pivots to maintain discharge at the water surface when pond levels rise or fall. Support for the airlift can be a post set in the pond bottom (Item 7, Figure 12.3) or in a concrete block (Item 4, Figure 12.2), that can be readily removed from the pond during harvest or moved from pond to pond. Any support system that maintains discharge at the surface would be suitable for airlift operations.

Size and pumping rates. Airlift pumps can economically mix oxygen-rich surface water with oxygen-deficient bottom water to improve environmental conditions in ponds (Parker

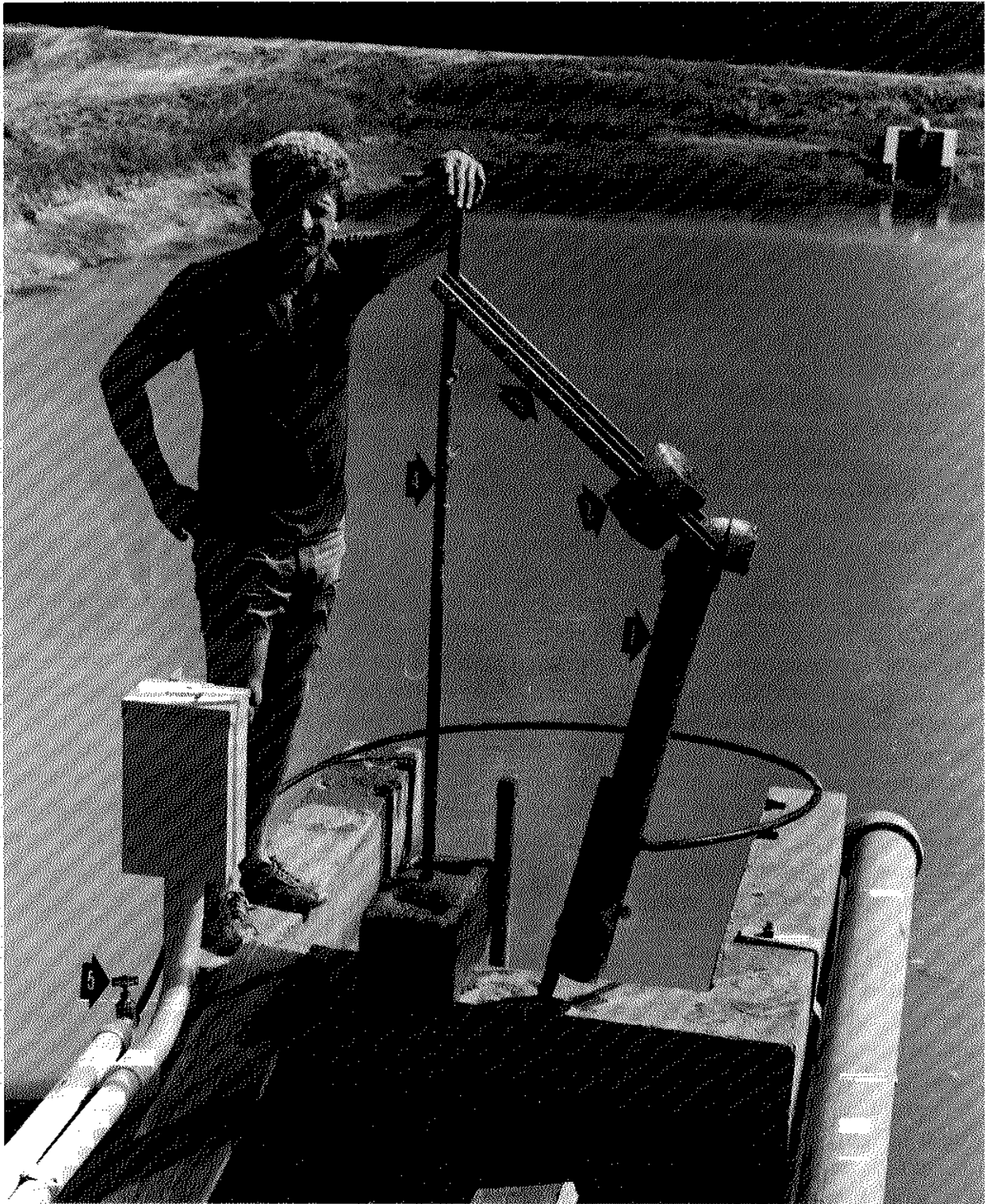

Figure 12.2. Airlift pump (1), with float (2), located on the swing arm assembly (3), and with the vertical support (4), cemented into a concrete block. Air supply to the pond is controlled by a valve. Photo Credit: Nick C. Parker.

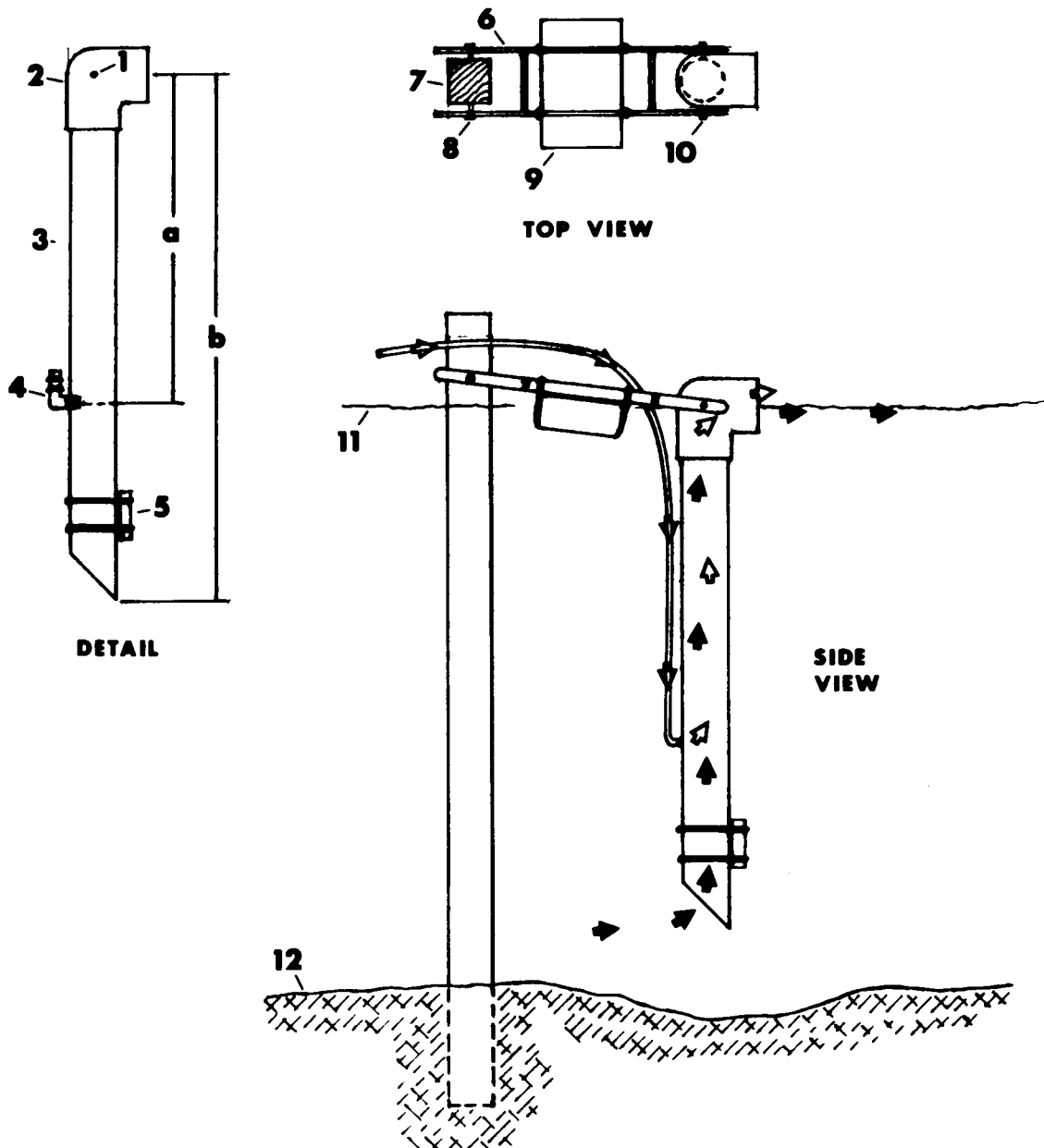

Figure 12.3. Construction detail and pond installation of a floating airlift pump. Detailed view of airlift pump with (1) hole for mounting airlift pump, (2) polyvinyl chloride (PVC) 90° elbow, (3) vertical riser constructed from PVC pipe, (4) 90° hose adaptor for air injection pipe, and (5) ballast with (a) depth of air injection dependent on air pressure available and (b) depth of airlift pump intake established by pond depth. Top view of (6) pump holder, (7) post anchor system, (8) pivot point, (9) flotation material, and (10) attachment of airlift pump to the pump holder. Side view of airlift pump installed with center of discharge at the pond surface (11), and with the intake just above the pond bottom (12). Direction of water (solid arrows) and air (open arrows) flow through the airlift pump (From Parker 1983).

1979, 1980). On the basis of material costs and operation, airlift pumps with a diameter of 3-4 inches seem to be the most efficient in circulating water within a pond. A detailed description of airlift pumping rates was given by Parker and Suttle (1987). When 3 cubic feet per minute (cfm) of air was injected 24 inches below the surface and the center line of the discharge was at water level (zero vertical lift), a 3-inch airlift pumped 43 gallons/minute and a 4-inch airlift pumped 75 gallons/minute. If the centerline of the discharge was raised 0.5 inches above the water level, flows decreased 16% for 3-inch and 38% for 4-inch diameter pumps, respectively. The proper adjustment of smaller diameter airlifts was easier to maintain than larger diameter airlifts. Regenerative blowers from 0.75-3 hp (0.56-2.24 kW) operated 27 3- or 4-inch airlift pumps per kW. The water pumping rate per kW of power was 300 gallons/minute for properly adjusted 3-inch airlifts, and 530 gallons/minute for 4-inch airlifts. Twenty-five airlift pumps, with a total operational cost of about \$1.25/day at \$0.07/kW-h, are recommended for 2.5-acre ponds with an average depth of 4 feet. This would circulate the entire pond volume in 2.1 days for 3-inch airlifts, and 1.2 days for 4-inch airlifts.

The point of air injection, not the total length of the vertical riser, is the critical measurement in airlift pump construction. Air injected into water at depths less than 24 inches decreases flow, whereas injection at depths greater than 24 inches requires higher air pressure and reduces total airflow available from regenerative blowers. Vertical risers 3 feet long work well in ponds that average 4 feet deep. Cutting the bottom of the vertical riser at a 45° angle allows continuous pumping if the water level drops and the riser touches bottom.

Regenerative blowers and airlift pump aeration systems have several advantages and disadvantages:

Advantages

1. They can replace or greatly reduce the number of electrically operated surface agitators.
2. Personnel safety is increased when several electrically powered surface agitators are replaced by one blower.
3. Small ponds can be economically circulated and destratified with airlift pumps.
4. Emergency aerator requirements are reduced.
5. Airlifts can be used during early culture of phase I fish.
6. Fish production can be increased when ponds are continuously circulated and aerated.

Disadvantages

1. Air delivery lines must be installed to all ponds with airlift pumps.
2. Pumps require adjustment at irregular intervals to keep them operating efficiently.
3. Airlift pumps can interfere with seining and may need to be removed when fish are harvested.
4. Airlift pumps may not provide adequate aeration in certain situations where DO declines rapidly.

Surface Agitators

Surface agitators (paddle wheels, pumps, floating aerators, etc.) are typically used to provide emergency aeration on an intermittent basis (Boyd and Ahmad 1987), but may be used continuously during summer in some locations. Small floating aerators are usually preferred over large paddle wheels for use in the small ponds typical of phase I culture. Emergency aeration with surface agitators is generally not recommended during the first half of phase I culture because of the risk of injury to small fish. They can, however, be used safely and effectively during late phase I and advanced culture. Depending on type, some surface agitators produce small zones of well aerated water with little circulation, or greater circulation with lower levels of DO.

Electric paddle wheels can be effective in rapidly restoring oxygen to ponds with low DO. Boyd and Ahmad (1987) found that in small ponds (from which all oxygen had been chemically removed by the addition of sodium sulfite and cobalt) this type of aerator produced oxygen at 1.1 pounds per hour and 10.6 pounds per hour at an operational cost of US \$0.16/hour for 1.5-kW units and \$0.79/hour for 8.5-kW units, respectively. They also determined that paddle wheel aerators were more efficient than diffused air systems, judged by the weight of oxygen added to deoxygenated ponds per unit of time. Rapid recovery rates make this type of aerator highly desirable for use in emergency situations, and improved designs now allow more cost-effective use of paddle wheels on a continuous basis.

One 1/3-hp floating aerator will normally provide sufficient aeration on an emergency basis for a 1-acre pond during production of phase I and phase II striped bass (about 3-10 inches long). Experience at the Southeastern Fish Cultural Laboratory has indicated that the availability of one 1/3-hp floating aerator for each two ponds in production should be sufficient to handle most emergency situations.

Liquid Oxygen and Oxygen Generators

Aeration may be provided for fish culture by an external source of pure gaseous oxygen. Oxygen can be purchased in liquid form, in which a large volume of oxygen gas is compressed in a relatively small cylinder; however, the tanks must be refilled or replaced (with full tanks) at frequent intervals. Commercially available oxygen generators provide a continuous flow of rel-

atively pure (95%) oxygen at rates up to 96 L/min. In most oxygen generators, compressed air is supplied to a material, such as zeolite, that absorbs and removes nitrogen.

Methods of dissolving pure oxygen into water include diffusers, packed columns, U-tube systems, and Aquatectors[®] (Speece 1969; Watten and Beck 1985). Diffusers consist of porous stones, rods, or plastic pipe, as well as serrated or slotted pipes, which are immersed directly in fish tanks or ponds. Oxygen is transferred more efficiently by small pore than by large pore diffusers or non-porous ones because the smaller bubbles they produce have larger surface area to volume ratios. However, small-pore diffusers require higher operating pressures and tend to clog easily. The efficiency of large pore diffusers can be increased by using an enclosed water column packed with plastic rings to increase bubble retention time.

Packed columns probably represent the minimum design to make the use of pure oxygen cost effective (Visscher and Godby 1987). A packed column usually consists of a 4- to 12-inch diameter sealed tube filled with plastic or other materials with high surface area to volume ratios. Water injected into the top of the column spreads across the surface of the packing media and absorbs the oxygen injected into the bottom of the column. Packed columns are normally operated under a vacuum of 20-50 mm Hg to effectively strip out nitrogen gas as oxygen is injected (Colt and Watten 1988).

In a U-tube system, water and oxygen are mixed and pumped down through a vertical pipe housed in a second, larger diameter pipe that contains the return flow. As the mixture of water and oxygen passes through the U-tube, hydrostatic pressure increases and oxygen rapidly diffuses into the water. Water exiting from the U-tube is fully saturated or supersaturated with oxygen. Commonly used U-tubes range from about 35-100 feet in depth. Essentially, they consist of a pipe placed inside a well casing with a plug at the bottom of the casing.

An Aquatector[®] (Zeigler Brothers, Inc., Gardners, Pennsylvania) is a device that mixes water and oxygen under pressure, shears the oxygen into micro-bubbles, and discharges the mixture into the rearing unit. The oxygen bubbles are so small and numerous that the discharge water appears milky white. Diffusion occurs across the tremendous surface area of the small bubbles.

Liquid oxygen, oxygen generators, U-tubes, and Aquatectors[®] are typically used in intensive culture situations where they are cost effective. The use of U-tube or Aquatector^R use in ponds requires either circulating the pond water through the device or the continuous use of new water. Biological fouling may be a problem with recycling pond water if sufficient fresh water is not available.

Transportation of Striped Bass Fingerlings

Successful transportation of striped bass begins at harvest. In summer, fish should be harvested in the early morning when temperatures are lowest, and fish are least sensitive to stress. If possible, fish should not be harvested when pond temperatures exceed 85°F. We

recommend that fingerlings be held in tanks for at least 24 hours after harvest to allow for recovery from stress. During this time, they should be treated in water containing 10 ppt salt (sea salt or NaCl) for 2-5 hours daily. Salt content should be reduced gradually through the slow addition of fresh water. Prophylactic treatments are commonly used for parasitic and bacterial infections before the fish are stocked (recommended therapeutants are discussed in Chapter 13). Antibiotics are commonly used as prophylactic treatments, before and during transportation, but their use as a standard practice is not recommended due to risk of inducing drug resistance in known pathogens (Brown 1989).

Hauling Medium

The hauling medium that we recommend for striped bass is water with a total hardness of 100 ppm (CaCO_3) or greater, to which salt has been added to bring the concentration to 10 ppt. Synthetic sea salt is preferred, but solar salt or non-iodized table salt may be substituted. Transportation of striped bass in soft water (<20 ppm CaCO_3) is not recommended; however, if only soft water is available, 50-1,000 ppm calcium chloride (CaCl_2) should be added to the transport medium unless a source of calcium is provided in the initial mix (see Chapter 8 for additional comments). Use of tricaine methanesulfonate (MS-222) is recommended to reduce activity and stress during transport (see Chapters 4 and 5 for additional comments on MS-222). MS-222 is approved by FDA for use on food fish, but requires a 21-day withdrawal period before treated fish are safe for human consumption (Schnick 1988). However, this anesthetic may not be the most desirable sedative for long-term exposure because its method of action induces stress in fish and may reduce oxygen consumption by asphyxiation rather than by lowering metabolism. (See Chapter 8 for additional comments.)

Water Quality

Dissolved oxygen during transport should be at saturation for the entire time the animals are held in the hauling tank. These levels are maintained by bubbling compressed oxygen or the gas from liquid oxygen through air diffusers, such as air stones, perforated tubing, or micropore tubing. Smaller bubbles yield more efficient oxygen transfer. Oxygenation of transport water should be started about 15 minutes before loading fish to ensure that sufficient oxygen is available. Surface agitators should only be used for larger (phase II) fish. Antifoam compounds may be used if desired; they are particularly beneficial when agitators are used for aeration. A complete change of water may be needed on hauls in excess of 8-10 hours to prevent ammonia and CO_2 build-up. When temperature of the transport and receiving water differs, the fish should be tempered at a rate no greater than 8°F per hour. Salt and any other additives must also be replaced if water in transport tanks is exchanged with fresh water.

Hauling temperatures ideally should be kept below 68°F on long hauls and below 75°F on short hauls for phase I fish. For phase II fingerlings, temperature should be kept below 68°F. Ice may be used to lower temperature; however, non-chlorinated ice is difficult to obtain while traveling. To protect fish from chlorine, ice made from chlorinated water can be sealed in plastic bags and floated in the transport water. Alternatively, a dechlorinating agent (e.g., sodium thiosulfate) can be added to the water.

Hauling Density and Tanks

Striped bass 1-2 inches long (500-1,000 fish/pound) may be hauled at 0.5 pounds per gallon for 1-4 hours, 0.3 pounds per gallon for 4-8 hours, or at 0.25 pounds per gallon for over 8 hours (Geiger and Parker 1985). Fingerlings averaging 5 per pound have been transported at rates of 1.5 pounds per gallon for 10 hours and 0.75 pounds per gallon for 15 hours. Many excellent insulated fiberglass or aluminum hauling tanks are commercially available. These tanks usually come complete with plumbing for oxygen distribution and provisions for mounting agitators. Continuous temperature and oxygen monitors visible to the driver are desirable. In the absence of oxygen monitoring equipment, an ammeter visible to the driver should be installed to verify the operation of each agitator. When small fingerlings are being hauled, the agitator wells should be covered with fine-mesh screen to prevent entrainment of fish.

Release

After arrival at the stocking site, fish must be acclimated to the temperature and quality of the receiving water before release. Receiving water should be pumped through the hauling tank for at least 1 hour (longer if the temperature difference is more than 2°F). Delivery of the fish through a quick-release valve is less stressful than removal with dip nets. If quick-release valves are used, the fish should be delivered through a tube submerged in the water, rather than allowed to free-fall to the surface. If fish must be netted, a soft, knotless, untreated net should be used; remove only a small number of fish at a time. Fish delivered to another hatchery or holding area should be slightly sedated with MS-222 before transfer by dipping, but stocking of anesthetized fish in the wild is not recommended due to the risk of predation on disoriented fish.

Stocking locations should be selected to allow fish the best chance for survival. Shoreline stocking into turbid water or cover of some type may reduce the risk of predation. Mid-reservoir stocking is less desirable if the fish must be handled an additional time. Also, the probable lack of adequate food and cover in mid-reservoir locations would require fish to move a considerable distance to locate food, thus increasing the possibility of predation.

Some agencies use nursery ponds constructed adjacent to, and connected with, a reservoir (see Chapter 8). Fry may be stocked directly into nursery ponds, reared to phase I and released. Phase I fish reared elsewhere may be stocked into a nursery pond and allowed time for recovery from handling before release.

Stress and Its Complications

Intensively cultured fish may be continuously or intermittently exposed to stressful conditions (Pickering 1981). Understanding the role of stress, its associated complications, and methods of avoiding stressful conditions, is imperative for successful culture.

The same basic physiological changes occur in men, mice, fish, and other vertebrates that are exposed to situations perceived as life-threatening. These changes may include a quick-

ening of pulse, an increase in respiration rate, widening of the eyes, contraction of muscles, alertness for danger, and development of the general adaptation syndrome described by Selye (1976).

Two hormones released almost immediately when a life-threatening situation is perceived are the catecholamines, adrenaline and noradrenaline (also known as epinephrine and norepinephrine). These hormones act very quickly to prepare an animal to fight or flee. The release of a second set of hormones, the corticosteroids, helps to sustain the fight-or-flight reaction.

The corticosteroids include three hormones: cortisone, cortisol, and corticosterone. Cortisol seems to be the most common and important of the corticosteroids in fish, but cortisone and corticosterone may be important in some species (Chester Jones et al. 1969). These hormones in fish are identical with those in humans and produce similar physiological changes.

Short-term elevations of corticosteroids may allow fish to flee from stressful life-threatening situations and thus may be beneficial. However, long-term elevation of cortisol and cortisone can be detrimental to the health of fish and result in reduced growth or actual weight loss (Davis et al. 1985), suppression of the immune system resulting in increased susceptibility to disease (Klinger et al. 1983; Pickering 1984), and disruption of osmotic balance or the ability to regulate electrolyte and water balance within the body (Mazeaud et al. 1977; Nikinmaa et al. 1983; Tomasso et al. 1980).

General characteristics of the blood can be measured to indicate the level of stress in an animal. Hormone levels (catecholamines and corticosteroids), electrolytes (sodium, potassium, and chloride ions), and metabolic by-products (glucose and lactate) can be evaluated biochemically. The cellular components of blood (red and white blood cells) can be analyzed histologically. Any deviations from normal resting levels may indicate that fish have been stressed.

Water Quality and Fish Density

Fish produced in hatcheries are commonly cultured at densities exceeding those found in the wild. As density increases, water quality usually decreases, and fish must adapt to less than optimum conditions. Crowding, low DO, high ammonia, and other factors can stress cultured fish. Environmental conditions suitable for survival of fish may not be adequate for growth, and even more exacting environmental conditions may be required to ensure successful reproduction (Parker and Davis 1981).

The stress response of fish is influenced by the rate at which water quality deteriorates. Tomasso et al. (1981) found that rapid deterioration of water quality was much more stressful than gradual changes, which allow fish more time to adapt.

Temperature

Aquaculturists have long known that survival of fish handled and transported is typi-

cally higher in winter than in summer. These differences may be partly attributed to differences in oxygen saturation of cold and warm water; however, in some species, temperature (Figure 12.4) strongly affects the resting level and secretion rate of corticosteroids (Strange 1980; Davis et al. 1984). The handling and transportation of fish at reduced water temperatures has been recommended (McCrary and Millard 1978), but this measure may reduce stress more effectively in some species than in others.

Anesthetics

Handling, grading, and transporting are some of the most stressful procedures to which fish are exposed. Just as physicians and dentists treat patients with anesthetics to reduce pain in surgery and medicine, aquaculturists can use anesthetics to reduce stress, or the secondary effects of stress, in fish. The principal anesthetics used for fish are MS-222, quinaldine, and etomidate. Corticosteroids increased significantly when striped bass were exposed to 25 ppm MS-222, 2.5 ppm quinaldine, or 10 ppt NaCl, but not when they were exposed to 0.1 ppm etomidate, either alone or in combination with 10 ppt salt (Davis et al. 1982). When striped bass were stressed by confinement in a net for 10 minutes, corticosteroid increases were reduced by quinaldine and MS-222, but not as effectively as by etomidate (Figure 12.5; also see Davis et al. 1982). Tomasso et al. (1980) found it beneficial to treat hybrid striped bass with 50 ppm MS-222 for 15 minutes before handling, and then to transport them in water containing 25 ppm MS-222 and 10 ppt of salt. Etomidate is an experimental drug that is not available to aquaculturists in the United States. Other experimental anesthetics may be equally effective, but will require additional evaluation and clearance by regulatory authorities before they become available for fish culture.

Salinity

Osmotic balance, the maintenance of salt (electrolytes) and water balance within the body of fish, is easily disrupted by stress. In general, fish blood has roughly one-third the salt content of sea water. In fresh water, fish must continuously expend energy to keep salt in the body and to excrete excess water. Conversely, fish in sea water must take water into the body and excrete excess salts.

Transportation of hybrid striped bass for 2 hours elevated corticosteroids almost immediately, and resulted in the delayed loss of chloride ions from blood plasma 72 hours after fish were released into fresh water (Tomasso et al. 1980). Transportation in anesthetic (25 ppm MS-222) and salt (10 ppt) did not prevent the delayed loss of electrolytes. However, when fish were placed in 10 ppt salt after transport and allowed to recover for 3 days, electrolytes remained within the normal range.

These data suggest that the detrimental effects of stress can be reduced by adjusting the salt concentration of the transport and recovery water to levels similar to that in fish blood. A reduction in the differential between the internal and external environment reduces the energy required by fish to maintain osmotic balance and helps to ameliorate osmotic disturbances caused by stress.

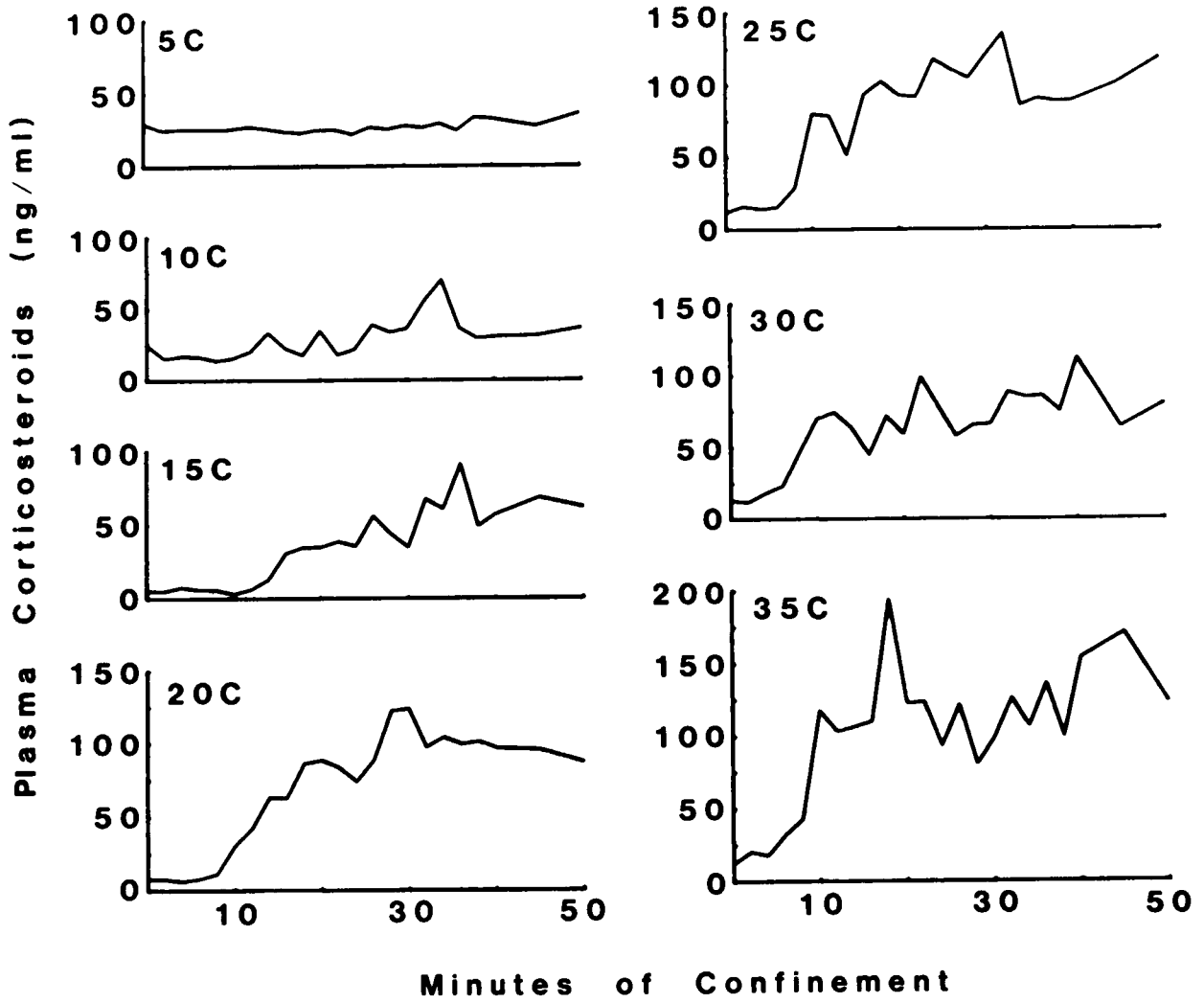

Figure 12.4. Plasma-corticosteroid secretion profiles for channel catfish acclimated to one of several temperatures, then stressed by confinement. Each point represents a fish. (From Davis et al. 1984).

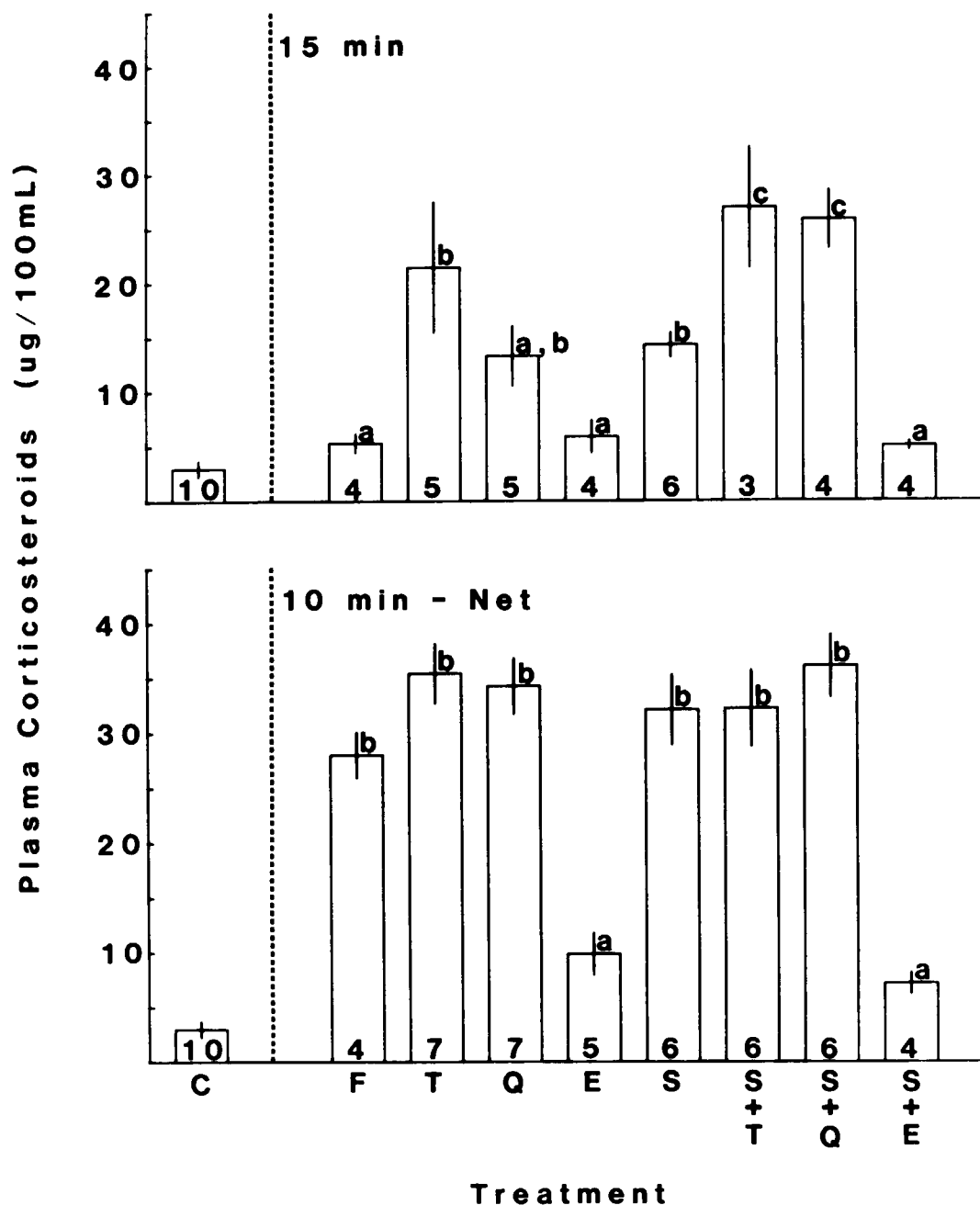

Figure 12.5. Plasma-corticosteroid concentrations (mean + SE) in undisturbed striped bass controls (C), fish exposed for 15 minutes to sedating concentrations of anesthetics and to salt (upper panel), and in fish exposed to anesthetics and salt and confined for 10 minutes in a dipnet (lower panel). F = freshwater controls; T = tricaine methanesulfonate; Q = quinaldine; E = etomidate; and S = salt. Number of fish is shown at the base of each column. Similar letters in each panel represent similar subsets at the 0.05 level by Duncan's multiple range test. Data represented in the upper and lower panels were not compared; undisturbed controls for reference only. (From Davis et al. 1982).

Secondary Stressors

A single acute stressor may trigger a series of physiological changes that persist for several days or weeks after the initial stress. After the initial recovery phase, a secondary rise in corticosteroids has been reported in channel catfish (Tomasso et al. 1981), hybrid striped bass (Tomasso et al. 1980), and largemouth bass (Carmichael 1984). This secondary increase resulted from osmotic failure, as indicated by the loss of electrolytes that followed the initial stress. Depletion of energy reserves (Nikinmaa et al. 1983), reduction in numbers of lymphocytes (Klinger et al. 1983; Pickering 1984), and reduction in granulocyte and thrombocytes (Klinger et al. 1983) probably increased the susceptibility of fish to secondary bacterial, parasitic, or fungal infections (see review by Wedemeyer 1970). Fish may survive one stressful event only to die when exposed to a second stressor.

Managing Stress

Aquaculturists may not be able to prevent fish from being stressed, but they can reduce the effects. In addition to the factors previously mentioned (species, temperature, water quality, handling procedures, etc.), other stress factors are sexual maturity, sex, and spawning (Mazeaud et al. 1977); time of year and time of day (Lamba et al. 1983; Pickering and Pottinger 1983); environmental contaminants (Passino 1984); and degree of domestication (Mazeaud et al. 1977). Factors that are stressful to warmwater fish may not be stressful to coldwater fish, and response to stressors in saltwater fish may differ from that in freshwater fish. Awareness of the stress response in fish and the factors influencing stress should allow culturists to reduce the effects. Fish loss due to stress can be reduced by several methods: (1) maintaining optimum environmental conditions; (2) handling and transporting fish at the lowest practicable temperature; (3) anesthetizing fish before and during handling; (4) handling and transporting freshwater fish at approximately isosmotic salinity (10 ppt salt); and (5) allowing fish to recover from one stressful situation before exposing them to another.

Controlled Spawning of Domesticated Brood Stock

Federal, state, and private hatcheries currently depend on collection and use of wild brood stock to produce striped bass and striped bass hybrids (Harrell 1984a). Such reliance results in some uncertainty regarding exact timing of natural spawning runs, and whether sufficient brood stock will be available to support desired production levels. Climatic conditions and other natural factors, as well as discharges from man-made water control structures, often determine the outcome from various hatcheries. Historically, use of wild brood fish has generally been satisfactory, but this may no longer be true as demand for fish for stocking purposes has increased substantially (Stevens 1984) — as has demand by commercial culturists. Concomitantly, recreational fishing pressure for potential brood stock is high (U.S. Department of the Interior 1982). Dependence on wild brood stock to support hatchery operations places private aquaculturists and, to a lesser degree, state and federal personnel in the position of competing with the public sector for "their" fish. Indeed, this perception may limit commercial development (Smith 1988). In an examination of the potential of striped bass and striped bass hybrids for aquaculture, the Joint Subcommittee on Aquaculture of the Federal Coordinating Council on Science, Engineering and Technology (1983) stated: "The major constraint to private

U.S. striped bass aquaculture is nonavailability of seed stock." Although many state hatcheries produce striped bass and hybrids, such hatcheries are typically unwilling to provide fish for commercial aquaculture (American Fisheries Society 1983). However, recent work suggests that controlled spawning of domesticated brood stock will offer hatchery operators an alternate source of fry (Smith and Jenkins 1984, 1988a; Smith 1987).

Culture Techniques

Striped bass can be reared from small phase I fingerlings to adults in indoor or outdoor tank systems. Cylindrical tanks, 20 feet in diameter and 5 feet deep, are preferred, although smaller tanks (12 feet in diameter x 3 feet deep) have been successfully used (Smith and Jenkins 1985). Fish can be reared in fresh or salt water, but water quality must be monitored regularly and maintained within normal culture limits. Recirculated water has been successfully used, although a flow-through water source is also acceptable and may be preferable.

Brood stock nutrition is important. Commercial trout diets have been used successfully as the main source of nutrition, supplemented with natural foods such as squid and fish. Striped bass should be fed several times daily when they are young, then feeding can be reduced to 1 or 2 times daily after they attain adult size. A pellet larger than the standard 0.25-inch trout grower pellet may be required for large adult striped bass to ensure that they receive sufficient feed. During culture of brood stock, handling should be minimized to reduce stress. Fish can be safely handled using anesthetics (e.g., MS-222), and handling appears less stressful to fish held in salt water than to those kept in fresh water. Periodically, parasitic and bacterial infections will occur, but normal prophylactic treatments will control most problems encountered (see Chapter 13).

Cultured striped bass can grow to nearly 1.3 pounds at age 1, 5.7 pounds at age 3, 9 pounds at age 4, and 14.3 pounds at age 5 (Figure 12.6). After juveniles have adjusted to pelleted feed, mortality should be insignificant, provided water quality and disease problems are carefully controlled. Wild white bass (*M. chrysops*) can also be successfully reared under captive conditions (Figure 12.6).

Age and Size at Maturity

Smith and Jenkins (1987) found that under culture conditions, about 22% of the males matured by age 2 and most were mature by age 3 (Table 12.1). In contrast, females did not begin to mature until age 3, when only 16% were mature; at age 4, 59% were mature.

Conditioning Techniques

Cultured striped bass males and females have been artificially conditioned to spawn out-of-season by manipulating photoperiod and temperature (Smith and Jenkins 1987). Natural conditions were simulated by using double tube fluorescent lights (three cool-white 34-W tubes per tank) and water chillers. The annual spawning cycle was accelerated 2-3 months, and fish were spawned in January and February (Figure 12.7). Similarly, striped bass males and white bass males and females can readily be brought into spawning condition in outdoor culture tanks exposed to natural temperature and photoperiod conditions.

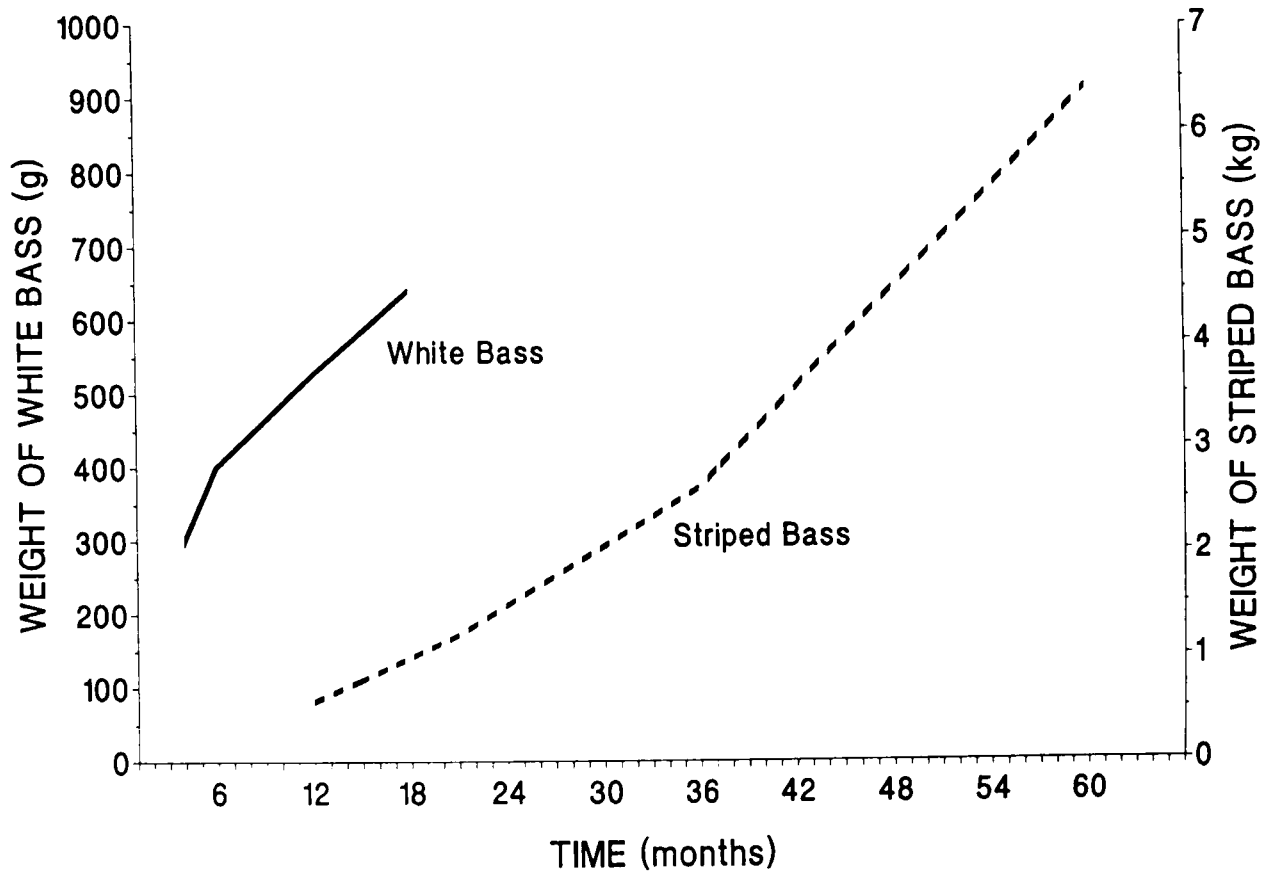

Figure 12.6. Growth of cultured striped bass and wild white bass in tanks.

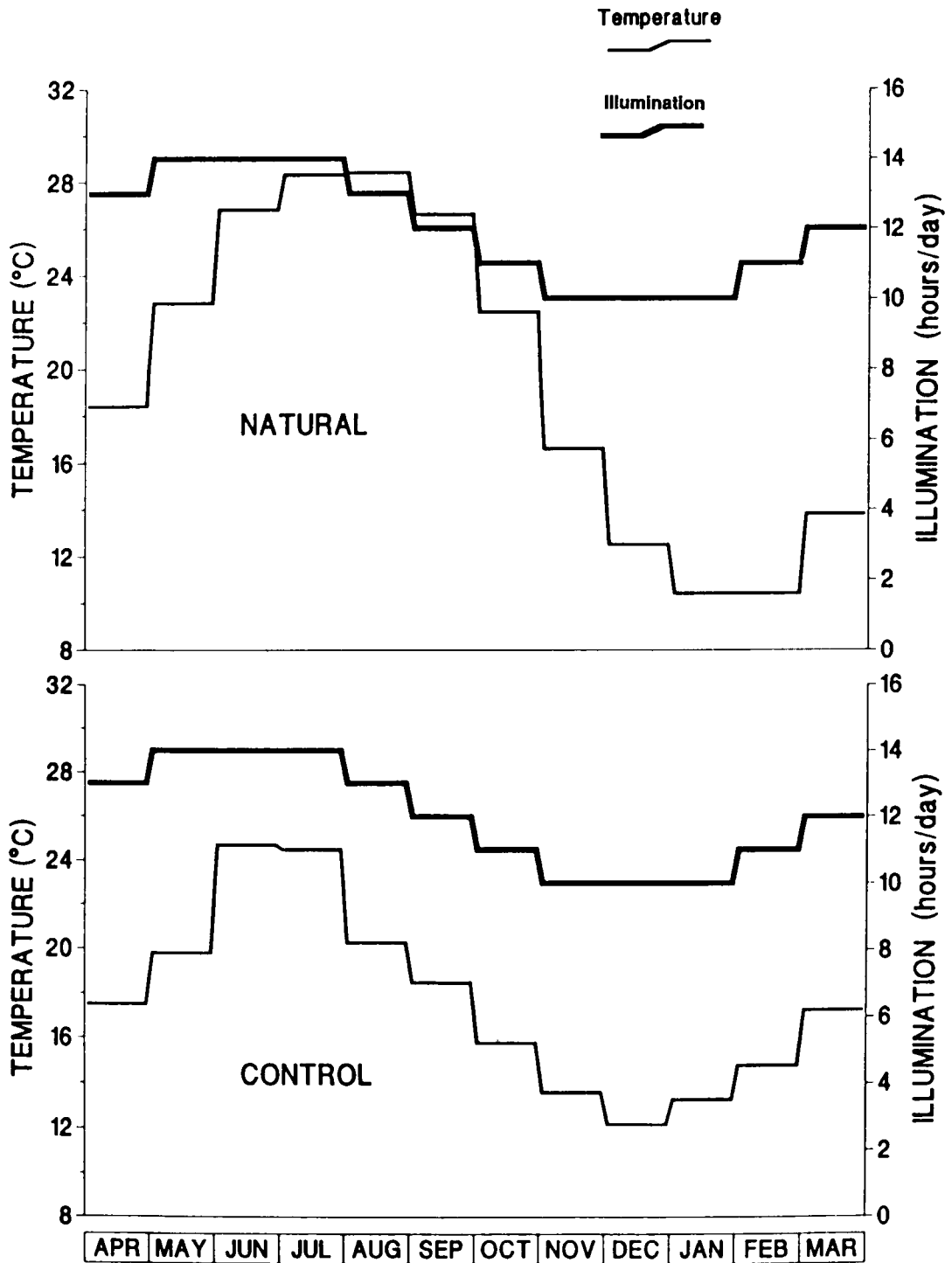

Figure 12.7. Natural cycles of photoperiod and temperature in South Carolina and the controlled cycle used to condition striped bass to spawn.

Table 12.1 Maturation characteristics of striped bass reared as brood stock under tank culture conditions (Smith 1988).

Age (years)	Males ^a			Females ^b		
	Mature ^c (%)	Total length (mm)	Weight (kg)	Mature ^c (%)	Total length (mm)	Weight (kg)
2	22	-	-	0	-	-
3	89	550	2.3	25	623	3.4
4	100	640	3.9	75	692	4.9
5	100	702	5.2	100	762	6.4

^a Fish from which milt could be expressed.

^b Fish with eggs more than 700 μm in diameter.

^c Based on number of males and females at 5 years of age; however, 19% of the fish were not mature at 5 years of age.

Spawning Techniques

In general, procedures for identification of mature fish, use of hormones, spawning, and egg incubation are similar to those used with wild fish (see Chapters 5 and 6). Extra care is required during handling to reduce stress and physical damage because the brood fish will be reused over several years. Typically, fish should be anesthetized before handling and treated prophylactically during and after handling to control disease. Brood fish are individually tagged for long-term identification so that the background of each fish is known during each spawning season (Smith and Jenkins 1987).

Benefits

Controlled spawning techniques have been demonstrated on a research scale. Work is now underway to develop these techniques for use in state, federal, and private hatcheries. Control over the spawning cycle has several advantages: (1) reduced dependence on wild brood fish; (2) year-round production of fry; (3) increased fry production; (4) accelerated domestication of stocks; and (5) development of selective breeding programs. For the geneticist, utilization of controlled spawning techniques would provide increased opportunities for genetic research and development.

Cryopreservation of Sperm

Cryopreservation of spermatozoa has become an important animal husbandry technique for mammals and birds. Extensive work has been done with various fish species with varying degrees of success. Yet, the technology for cryopreserving fish gametes has lagged behind that in other animal husbandry fields. Currently, spermatozoa from a variety of fish species can be successfully cryopreserved, although fertilization percentages are normally less than when fresh semen is used. Methods are sufficiently advanced for some species to be used successfully for experimental breeding programs, but are not yet adequate for normal use in production facilities (Kerby 1983; Kerby and Bodolus 1988). Recent progress, particularly in the area of extender development and freezing techniques, promises more practical use in the future.

Striped bass brood stock are usually collected on or near the spawning grounds; still, hatcheries sometimes have difficulty in obtaining an adequate supply of ripe males (Bayless 1972; Bonn et al. 1976). This paucity of males is particularly evident late in the spawning season when ripe females may be abundant. Additionally, because the spawning of white bass typically peaks earlier than that of striped bass, collection of male white bass for use in production of hybrids is often difficult.

These difficulties provided the impetus for efforts to cryopreserve striped bass spermatozoa (Figure 12.8) (Kerby 1983, 1984; Kerby et al. 1985; Kerby and Bodolus 1988).

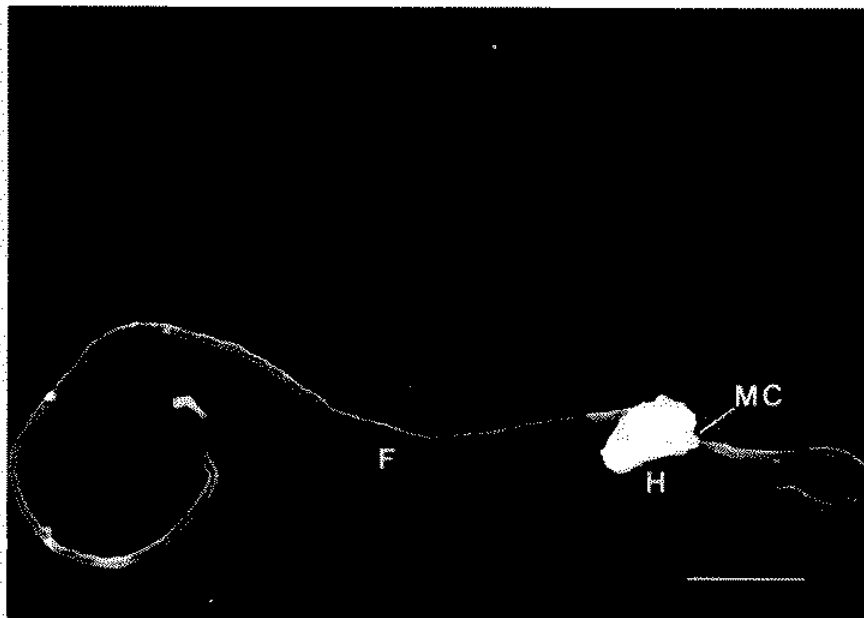

Figure 12.8. Scanning electron micrograph of striped bass spermatozoan showing the relative positions and dimensions of the head (H), mitochondrial collar (MC), and flagellum (F). Bar = 2 μm (from Kerby and Bodolus 1988).

Although efforts were successful, and several million larvae were produced over a period of 4 years, methods are not yet sufficiently refined to be used reliably in production hatcheries. The techniques can, however, support experimental work where consistently large numbers of progeny are not required. The best results have been obtained using controlled-rate freezing systems (Linde BF4/6 or CRYO-MED Model 900 systems) utilizing liquid nitrogen (LN₂) for the freezing process. We next summarize previous results and preferred methods for those interested in applying the methods in their work.

Experimental Results

Initial efforts (Kerby 1983) were designed to identify suitable extenders and cryoprotectants for striped bass by evaluating various extenders and cryoprotectants developed for other species. An extender is defined as a solution of salts, sometimes including organic compounds, which helps maintain the viability of cells during cryopreservation, whereas a cryoprotectant is defined as an organic compound which protects the viability of cells during the freezing and thawing process (Ott 1975). These trials normally involved small amounts (1 mL) of extended semen (0.2 mL of semen and 0.8 mL of freezing medium — extender plus cryoprotectant). Different protocols, including various freezing rates, were also evaluated. Freshly ovulated striped bass eggs (about 300 per trial) were challenged with thawed cryopreserved sperm to determine fertilization capacity.

Results demonstrated that striped bass sperm could be successfully cryopreserved by using several different extenders combined with dimethyl sulfoxide (DMSO) as the cryoprotectant. The best overall results were obtained with an extender (OH-189) developed by Ott (1975) for salmonid sperm (Table 12.2). Dimethylsulfoxide, added at an optimum concentration of 5%, was the only cryoprotectant tested that was successful. The freezing medium was mixed in a 1:4 sperm:medium (volume:volume) ratio and frozen in 1 mL aliquots in 2 mL A/S NUNC polypropylene cryotubes obtained from Union Carbide Incorporated. The best mean fertilization percentage obtained with cryopreserved sperm was 23.6 (range, 0-87%). Other extenders producing good results were OH-134, OH-235, and OH-275 (Table 12.2). Mean freezing rates between 5 and 20°C per minute were more effective than slower rates (Kerby 1983).

Although some fertilization could be consistently obtained with cryopreserved sperm, and fertilization capacity could be retained for at least 4 years, fertilization percentages of individual tests varied considerably from one trial to the next. Inconsistency was partially due to variation in gamete quality among females and perhaps males. Other important variables that may affect fertilization success include small variations in technique and repeatability from one trial to the next in both the freeze-thaw and the fertilization processes. Fertilization percentages from cryopreserved sperm were seldom comparable with those of fresh sperm. Results of 48 individual tests with extender OH-189 (Table 12.3) showed the variability obtained at different freezing rates, with different sample lots, and with different females.

Production Experiments

Female striped bass normally produce from 1-4 quarts (1-4 L) of eggs, depending on the size of the fish (1 quart per 10 pounds or 1 L per 4.5 kg of body weight as a rule-of-thumb), and

Table 12.2. Chemical composition of extenders used to cryopreserve striped bass sperm (grams of solute/liter total solution). Add 5% dimethyl sulfoxide (volume/volume) as the cryoprotectant.

Chemical	OH-189	OH-134	OH-235	OH-275
NaCl	7.30	7.30	8.50	8.50
KCl	0.38	0.38		
CaCl ₂ ·2H ₂ O	0.23	0.23		
NaHCO ₃	5.00	5.00	5.00	3.75
NaH ₂ PO ₄ ·H ₂ O	0.41	0.41		
MgSO ₄ ·7H ₂ O	0.23	0.23		
Fructose	5.00	1.00		
Lecithin	7.50	7.50	5.00	7.50
Mannitol	5.00			

Table 12.3. Percent fertilization (mean ± SE; ranges in parentheses) of striped bass ova challenged with sperm frozen and stored in liquid nitrogen (-196°C). Extender was OH-189, containing 5% DMSO. Sperm:medium ratio was 1:4. Mean freezing rate (°C/min) was calculated between range of +10 to -40°C.

Sample lot number	Mean freezing rate	Number of trials	Range in time frozen (Days)	Treatment of sperm					
				Cryopreserved			Fresh control		
35	11.1	8	0.6-701	11.9 ± 4.3	(0-37)	64.4 ± 6.3	(33-87)		
39	2.4	4	0.6-321	11.3 ± 4.4	(3-22)	68.5 ± 11.9	(33-66)		
41	3.5	5	1.2-696	19.4 ± 7.5	(12-55)	64.9 ± 3.6	(56-77)		
45	7.6	5	1.1-696	29.2 ± 7.8	(12-55)	55.4 ± 11.4	(29-92)		
49	11.4	5	1.7-696	21.9 ± 7.4	(0-39)	61.9 ± 12.9	(28-89)		
53	17.0	4	0.2-694	8.8 ± 2.2	(3-13)	56.9 ± 9.4	(29-72)		
61	7.4	3	0.8-002	49.6 ± 19.6	(22-88)	89.2 ± 4.1	(82-96)		
65	13.0	6	0.3-373	46.2 ± 3.9	(36-58)	61.3 ± 11.7	(11-89)		
69	8.4	6	1.2-734	26.2 ± 7.3	(9-57)	72.8 ± 8.6	(36-92)		
73	8.0	2	358	9.7 ± 4.8	(5-15)	49.6 ± 7.8	(42-57)		

hatchery managers usually use semen from at least two males, with a total volume of semen ranging from 10-30 mL per batch of eggs. Kerby (1983) noted that cryopreserved sperm cannot be expected to have a fertilization capacity equivalent to fresh sperm. Semen is diluted 1:4 with the protective extender, so large quantities of extended semen must be preserved and stored.

Storage containers for freezing large volumes of semen are not commercially available, so for production studies, polyethylene, polypropylene, stainless steel, and teflon containers were fabricated and evaluated (Kerby and Bodolus 1988). Because acceptable results were obtained in initial experiments with 2-mL and 5-mL polypropylene cryotubes (Kerby 1983), the custom-fabricated tubes had inside diameters and a configuration similar to the original vials. Wall thickness and heat transfer properties varied among tubes constructed of various materials. The tubing was cut in 11.8 inch lengths and sealed at one end by tightly inserting a rubber stopper. The volume of the fabricated containers was approximately 20 mL.

Semen was extended in OH-189 containing 5% DMSO at temperatures (15-18°C) corresponding to hatchery water temperatures. Each sample tube was filled with 18 mL of extended semen and immediately frozen in a CRYO-MED controlled-rate freezer at rates ranging from 5-15°C per minute, or the samples were placed directly in the freezing chamber pre-chilled to temperatures of -60 or -100°C. All samples were lowered to a temperature of -60 to -80°C in the freezer before being transferred to LN₂ for storage.

Samples of cryopreserved sperm were rapidly thawed in a 50-60°C water bath and tested with fresh eggs to determine fertilization rates. To simulate production conditions, 200 mL egg aliquots (ca. 200,000 eggs) were fertilized by adding nearly thawed semen from three or four tubes (54 or 72 mL), fresh hatchery water, and stirring gently. Eggs were then incubated in modified MacDonald hatching jars (Kerby and Bodolus 1988).

Fertilization percentages for sperm preserved in "production" quantities ranged from 0-61.5%. In general, a freezing rate of 5°C per minute provided the best overall results; mean fertilization percentages were 16.2 for the polyethylene tubes, and 14.2% for the polypropylene tubes. Results often ranged between 10 and 40%. Trials in which semen was rapidly frozen by placing it in the chamber pre-chilled to -60 or -100°C usually yielded fertilization percentages between 9 and 35%. Trials with stainless steel and teflon produced generally poor fertilization percentages.

Growth and Survival Experiments

Striped bass eggs fertilized with frozen-thawed sperm resulted in apparently healthy larvae. However, it was desirable to determine if growth and survival of "cryogenic" larvae were comparable with those of "natural" larvae obtained from eggs fertilized with fresh sperm.

Kerby et al. (1985) reported that in two pond experiments designed to assess relative growth and survival between natural and cryogenic larvae to the phase I fingerling stage, there were no significant differences between harvest numbers, weights, or survival. Although larger

numbers of natural fish were produced, cryogenic fish — probably because of their lower relative densities in the ponds — were significantly bigger than natural fish.

Due to the variability inherent in pond culture experiments, it is difficult to adequately assess the lack of significant differences unless many replicates are used. Between-pond variability was so large that it could have masked significant differences between treatments. Based on previous experience, Kerby et al. (1985) concluded that production and size differences were probably caused by environmental differences in culture conditions between ponds, and not to the experimental treatments. Results from the study clearly indicated that striped bass produced by cryopreservation techniques were normal, and they appeared as viable as fish produced with fresh sperm (Kerby et al. 1985).

Recommended Procedures

There are a number of technique "tricks" in the cryopreservation process that can be learned only by trial-and-error or from experience. We here attempt to provide some of those techniques.

Use only freshly-collected males that produce free-flowing milt when slight pressure is applied to the abdomen. Wipe the abdomen with a damp towel to avoid contamination of semen with water or mucus from the body. Strip into a cool, dry container. Discard samples contaminated with blood, contain large quantities of urine, or are highly viscous and do not mix easily with water (forms clumps).

Before freezing, test for sperm motility by placing a very small drop of semen on a glass slide. Activate the spermatozoa with a drop of hatchery water and observe them under oil immersion with a compound microscope (magnification 1,000X). This procedure must occur rapidly, as motility lasts only 30 to 60 seconds after activation in fresh water. Use only semen containing highly motile spermatozoa. Keep the collected semen cool (15-18°C), process it, and initiate the freezing procedure immediately. It is best to process the semen at a room temperature of 15°C or less.

Processing semen. Extenders should be refrigerated (38°F). Prepare a freezing medium by adding 5% DMSO to the extender. Add the semen to the freezing medium (1 part semen:4 parts medium). Extender OH-189 is preferred (Table 12.2).

The semen-medium mixture can be prepared several ways. In one, the cap (or needle) from an appropriately-sized syringe is removed and the semen is drawn into the syringe. Then the appropriate amount of semen is added to a pre-measured volume of medium. Alternatively, remove the plunger from the syringe (with the hub capped) and pour the desired amount of semen into the barrel of the syringe. Replace the plunger, remove the cap, and adjust the volume of semen to coincide with the prepared volume of medium. Add to the freezing medium and mix well. After mixing, an automatic pipet system, such as a Repipet Jr.^R (available from scientific supply companies) is an excellent way to rapidly and accurately dispense the semen-medium mixture to the freezing containers. At present, probably the best freezing con-

tainers are the 5-mL NUNC cryotubes. If larger containers are desired, they can be fabricated from polyethylene or polypropylene tubing as previously discussed.

Immediately after mixing, distribute the extended semen to the freezing containers, place them in the freezing chamber, and initiate the freezing process. If 5-mL cryotubes are used, they should be attached to aluminum holding canes and placed in a freezing rack. If longer containers are used, they can be placed in the rack individually. A freezing rate between 9 and 18°F (5 and 10°C) per minute is recommended. Individual containers should be labeled to identify each frozen batch. If later experience indicates that a particular batch is of poor quality, it can be discarded.

As an alternative to controlled-rate freezing equipment, which is very expensive, containers of extended semen can be immersed in an ice chest containing crushed dry ice (frozen CO₂) or suspended in the vapor above liquid nitrogen in a LN₂ refrigerator. Based on experience, ambient temperature in the freezing chamber should be from -60 to -100°C.

The temperature inside one of the containers of semen should be monitored by means of a thermocouple placed within the container. Temperature of the frozen sperm should be at least -60°C before removal from the freezing chamber. It is very important that the containers of frozen sperm be transferred as rapidly as possible to the storage container containing LN₂. Even short-term contact with ambient room temperatures can cause a rapid elevation of sample temperatures. The frozen sperm should be stored in LN₂ until ready for use.

Thawing frozen semen. Preparations for use of stored sperm should be made before eggs are taken from the female. A water bath containing about 55°C water is necessary for thawing frozen semen. The containers of sperm to be used should be isolated in the LN₂ storage container for quick access. About 40 to 50 mL of extended semen should be used per 100 mL of freshly ovulated eggs. Thawing should begin shortly before (or at the same time) the female is spawned. The containers of stored sperm should be agitated vigorously in the water bath until almost thawed (slush phase). At this stage, pour the semi-thawed semen into a beaker, keeping it separate from the eggs. Be sure not to completely thaw the semen before removing it from the water bath as over-heating can easily occur and kill the spermatozoa. When the semen has been thawed and concentrated in the beaker, add it to the eggs simultaneously with hatchery water. Gently stir the mixture of eggs and semen for at least 1 minute. Leave the eggs in the semen-water mixture for 3 to 5 minutes, decant the water, and incubate the eggs according to normal practice.

The whole process of thawing and fertilization should be done as rapidly as possible. Ideally, thawed sperm should reach the "slush" phase just as stripping of the female is completed.

Accurate fertilization percentages can easily be determined 3 to 4 hours following fertilization. It is recommended that at least one group of eggs be fertilized with fresh sperm as a control if possible to provide some assessment of the quality of each batch of stored sperm.

Parasites and Diseases of Striped Bass and Hybrids

Janice S. Hughes, Thomas L. Wellborn, and Andrew J. Mitchell

Striped bass (*Morone saxatilis*) and hybrid striped bass are cultured in stressful, unnatural conditions, and outbreaks of infectious diseases, particularly bacterial diseases, are usually precipitated by stress. Most bacterial pathogens of striped bass are normal inhabitants of water (Paperna and Zwerner 1976) and do not cause problems as long as the immune system of the cultured fish is not compromised by a stressor. Healthy fish can resist many bacterial, parasitic, and viral pathogens; thus, prevention, not treatment, is the key to minimizing losses due to infectious diseases. Anything that can be done to eliminate or reduce stress will diminish losses. Chemical treatments are a crutch and should be used only when necessary, and when it is certain that chemicals will prevent or correct the problem.

Diagnosis of bacterial, viral, parasitic, and fungal diseases requires accurate identification of the pathogen using specific laboratory procedures. In many cases, fish mortality can be the result of a multiplicity of causes (e.g., concurrent infections of *Aeromonas* sp., columnaris disease, and low oxygen levels). It is necessary to do a complete examination of the sick fish, including water quality testing, to ensure that all causes of the problem are identified. Failure to do this can result in catastrophic losses. It is beyond the scope of this publication to give a detailed explanation of the methods and materials for the isolation and identification of pathogens. These can be found in the publications by Amos (1985), Bullock (1971) and Post (1987). Instead, we will concentrate on providing a summary of some reported diseases affecting striped bass and their treatments.

Bacterial Diseases

Motile Aeromonad Septicemia

The most common systemic bacterial disease of cultured fishes worldwide is probably motile aeromonad septicemia (MAS). It is caused by bacteria of the *Aeromonas* group, although bacteria from the genus *Pseudomonas* cause a very similar disease in fish. These organisms cause comparable clinical signs, so they will be discussed together. They are common inhabitants of fresh water, are opportunistic rather than obligate pathogens, and are found worldwide in virtually all fresh water streams and lakes.

Although most outbreaks of MAS occur in the spring and summer, the disease can occur any time of the year, and fish of all ages can be affected. Outbreaks of MAS are often preceded 3-7 days by some form of stress (e.g., low oxygen, high carbon dioxide, high ammonia, rough handling, shipment). Any measure taken to reduce stress will certainly reduce the chance of a MAS outbreak.

Clinical signs of MAS infections are highly variable, and can be confused with a number of other diseases if the diagnosis is based only on the behavior and appearance of affected fish, because fish with an acute infection can appear healthy. External clinical signs associated with subacute and chronic infections are highly variable and may include: small bloody spots (petechiae) on the body and fins; irregular grayish-red lesions on the body; shallow, regular to irregular grayish-red ulcers on the body; eroded fins; raised scales; hemorrhagic and eroded mouth; protruding eyes (exophthalmia); distended abdomen; protruding and inflamed vent; and a yellowish discharge from the vent.

Internal clinical signs may include: pale and swollen kidney and liver; flaccid and inflamed lower intestine; numerous small hemorrhages present in all internal organs, mesenteries and peritoneum; absence of food or feces in the stomach and intestine; a yellow mucus-like material in the lower intestine; and a cloudy, yellow to bloody, pus-like fluid in the body cavity.

The first behavioral sign usually noted in MAS outbreaks is a reduction in feeding activity. As the disease progresses, infected fish stop feeding entirely, aggregate in shallow water, and swim listlessly close to the surface and at an angle.

Isolating the MAS organism on the appropriate bacteriological media, and then identifying it, is the only way an accurate diagnosis can be made.

Oxytetracycline (Terramycin®) incorporated into the fish feed is the drug of choice for the control of MAS. It should be fed at the rate of 25-38 mg of active drug per pound of fish daily for 10 days. A high rate of drug resistance to Terramycin® has developed among motile aeromonads and pseudomonads in fish and treatments should be given only after the causative organism has been isolated, identified, and drug sensitivity tests have shown the organism to be sensitive to the drug. Oxytetracycline and other drugs mentioned later are not registered for the treatment of bacterial problems in striped bass which will be used for human consumption.

Vibriosis

Vibriosis is a systemic bacterial disease of fish cultured in brackish and marine waters, and occasionally occurs in freshwater fish. Like bacteria which cause MAS, pathogenic species of the genus *Vibrio* are probably ubiquitous in marine and brackish waters. Fish of all ages can be affected. In other fish species, problems usually occur at temperatures above 50°F. *Vibrio* spp. occur worldwide and are facultative organisms that usually cause problems following stress. The clinical signs of vibriosis are similar to, and can be confused with, MAS unless the bacteria are isolated and identified biochemically.

Disease prevention is best accomplished by maintaining good sanitation and minimizing stress on the fish. Although immunization against vibriosis has proven effective in some species of salmon (Bullock 1977; Post 1987) and striped bass (Williams et al. 1981), the vaccine is not approved for use in striped bass.

Terramycin® has been effective for control of vibriosis when mixed with food and fed at a rate of 25-38 mg active drug per pound of fish for 10 days. Sulfamerazine, incorporated into the food and fed at the rate of 0.8 g active drug per pound of fish for 10 days has been an effective control.

Columnaris Disease

Columnaris disease, caused by *Flexibacter columnaris* and other closely related bacteria, may be the most important freshwater disease of striped bass (Mitchell 1984). It is usually reported as an external infection, but can occur as a systemic infection. *F. columnaris* is a facultative pathogen that is common in water and on the skin and gills of fish. All ages of fish are susceptible, and the disease occurs worldwide. It usually appears when water temperatures are higher than 54°F and may take an explosive course when water temperatures are higher than 86°F.

As with other bacterial diseases of fish, the clinical signs associated with columnaris disease are highly variable. The physical signs on striped bass vary from no external signs in systemic infections to large, irregular, shallow, dirty-looking ulcers in external infections. The disease may first appear as a thickening of the mucus anywhere on the body and, as it progresses, the lesion enlarges to form a light, grayish-blue patch occasionally with reddened edges. The fin margins may become thickened and opaque, but they may soon become eroded, with few rays left intact. Sometimes only the gills or the inside of the mouth will be involved. The tips of the gill filaments may become lighter in color and then rapidly become necrotic. Lesions on the gills and in the mouth are usually yellowish-brown in color due to the large numbers of bacteria present.

When the infection is systemic there may be no physical signs, but the organism can be seen in gram-stained smears of kidney material and is easily isolated on suitable media (T. L. Wellborn, unpublished data). Affected fish reduce feeding activity, swim slowly at the surface, and aggregate in shallow water in ponds or at the lower end of raceways.

A presumptive diagnosis of external infections is made by finding the typical "columns" or "haystacks" on microscopic examination of skin scrapings and gill clippings (Figure 13.1). Systemic infections can be presumptively diagnosed only by isolating the organism on a selective medium and finding the typical rough, dry, rhizoid-like, yellowish colonies which adhere to the agar. Biochemical or enzymatic tests are necessary for definitive identification of the pathogen.

Preventing stress, particularly during hot weather, is the best way to minimize the chance of columnaris outbreaks. For external infections, a treatment of 2 ppm potassium

permanganate is very effective if the red color imparted to the water remains for at least 10 hours; if the color changes to a yellow-brown in less than 10 hours, a repeat treatment is necessary.

If a systemic infection has been confirmed, the use of Terramycin® medicated feed, fed at a rate to give 25-38 mg active drug per pound of body weight for 10 days, is effective. Do not feed ormetoprim + sulfadimethoxine (Romet-30®) since *F. columnaris* is refractive to this drug.

Edwardsiella septicemia

Edwardsiella septicemia (ES), caused by *Edwardsiella tarda*, has been reported once in striped bass held at the National Fish Health Research Laboratory in Leetown, West Virginia (Herman 1985). Although it is not now a problem for striped bass culturists, it has been found in six other fish species cultured in the United States.

Herman (1985) reported that striped bass with ES swim lethargically near the surface, have pale gills, a light-colored area on the head between the eyes, and internal changes which had to be determined by histological examination. A diagnosis is made only by isolation and identification of the pathogen.

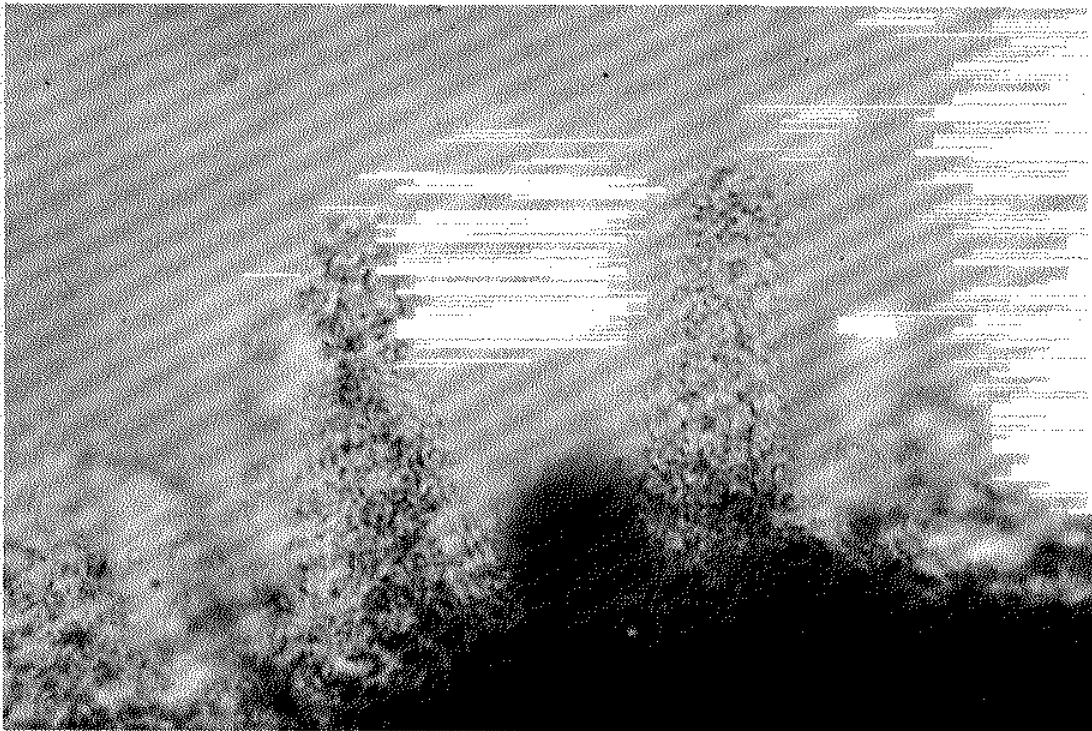

Figure 13.1. *Flexibacter columnaris* — bacteria colonies forming columns. Photo Credit: G. L. Hoffman.

If possible, remove infected fish from the population. Treatment consists of feeding Terramycin[®], mixed in the food, at the rate of 25-38 mg active drug per pound of body weight for 10 days.

Pasteurellosis

This disease, caused by *Pasteurella piscicida*, has been reported twice in striped bass in marine and brackish water situations; once in 1963 from the Chesapeake Bay (Snieszko et al. 1964) and in 1985 (Hawke and Minton 1985) from the Claude Peteet Mariculture Center, Gulf Shores, Alabama. Mortality was very high in both incidences. *Pasteurella piscicida* has also been isolated from cage-cultured yellowtails (*Seriola quinqueradiata*) in Japan (Bullock 1978); therefore, a very wide geographic distribution of the pathogen is likely. Disease outbreaks occurred in the spring, summer, and fall when water temperatures ranged between 73 and 79°F. A definitive diagnosis must be made by isolation and identification of the organism.

Predisposing stress factors are unknown, but following good management practices should be beneficial in reducing the chance of an outbreak.

Hawke and Minton (1985) reported control of an outbreak of *Pasteurella piscicida* in striped bass by feeding oxytetracycline HCl. Initially, the fish were fed at the rate of 23 mg active drug per pound body weight per day for three days, and then the dose was increased to 68 mg active drug per pound body weight per day for 14 days. Outbreaks in cultured yellowtails in Japan were controlled by feeding sulfamerazine at 91-182 mg/pound body weight per day for 6 days (Matsusato 1975).

Mycobacteriosis

Mycobacteriosis, or fish tuberculosis (*Mycobacterium* sp.), has been reported only from striped bass in aquaria on the East Coast (Nigrelli and Vogel 1963) and from striped bass in natural waters on the West Coast (Sakanari et al. 1983).

No external clinical signs have been reported from striped bass infected with *Mycobacterium* sp. Snieszko (1978) stated that in other species of fish, external clinical signs become more apparent at high water temperatures and high densities. External clinical signs in other species of fish include: emaciation; reduced feeding; exophthalmia (popeye); shallow, grayish, irregular ulcerations; deformed vertebral column; and difficulty in maintaining balance. Internal clinical signs in striped bass are small grayish tubercles (nodules) in the liver, kidney, and spleen. These range from 80 to 500 µm in diameter (Snieszko 1978). Finding acid-fast bacteria in stained smears of material from lesions is diagnostic of mycobacteriosis.

To greatly reduce the chance of infection, ground fish used for feed should be cooked prior to feeding. No control or treatment methods are known.

Chlamydia-Like Organisms

Epitheliocystis

Epitheliocystis is a disease caused by an obligate intracellular organism; its exact taxonomic position is uncertain. It has been reported once from striped bass from the Thames River in Connecticut (Wolke et al. 1970). The disease is considered rare and of no consequence in striped bass culture at this time.

In striped bass, epitheliocystosis lesions are confined to the gills, where they appear as small (up to 1 mm in diameter), white raised areas on the lamellae. There is no report of other gross physical or behavioral signs associated with the disease. Affected epithelial cells of the primary lamellae of the gills become enlarged (hypertrophy) and may increase in size to 50-60 μm . Histological examination of infected gill tissue is required for diagnosis. No treatment or control measures are known.

Virus Diseases

Lymphocystis

Lymphocystis virus disease (LVD) is caused by an iridovirus. It has been reported in striped bass from the East Coast of the United States (Krantz 1970), but has caused few problems in culture ponds and raceways. Summer and early fall are the most common times of occurrence. This is a slow-developing, chronic disease characterized by tumor-like masses on the skin and fins of affected fish. Although not fatal, affected fish are aesthetically not acceptable to fishermen or consumers. Signs of LVD include wart-like growths or lesions on the fins and skin that vary in color from white, grayish-white to pinkish, and may have a raspberry to cauliflower-like texture. No behavioral signs are associated with the disease. The general appearance of lesions will suffice for a presumptive diagnosis, although a histological examination of the affected tissues is necessary for a definitive diagnosis. Affected fish should not be moved to hatcheries that are free of the virus. There is no known treatment for lymphocystis disease; however, it tends to disappear in the fall as the water temperature drops.

Infectious Pancreatic Necrosis

Infectious pancreatic necrosis virus (IPNV) has been isolated from striped bass in the Chesapeake Bay region, but seems to cause no problem (P. E. McAllister, U.S. Fish and Wildlife Service, National Fisheries Research Center-Leetown, personal communication). Striped bass may serve as carriers of IPNV and may be a source of infection for salmonids in the same body of water. Striped bass carrying the IPN virus exhibit no physical or behavioral signs, nor is there any histopathology.

Confirmatory diagnosis requires identification by serum neutralization of the virus (Amos 1985). There is no known treatment for IPN. Contaminated facilities can be disinfected with chlorine at 200 ppm for one hour.

Fungal Diseases

External Fungal Diseases

External fungal infections of striped bass can be caused by different fungi, probably including species from the genera *Achlya* and *Saprolegnia*.

Fungus infections can occur wherever striped bass are cultured in fresh water, and are seen most commonly during late fall to early spring. External fungus infections are usually secondary to other problems that can bring on disease, such as poor water quality, toxins, poor nutrition, handling, and infectious diseases. Mortalities from fungus infections can be high and usually are directly related to stocking density.

Clinical signs of external fungus infections include: a cotton-like growth on the skin; a discolored film on the surface of the fish; patches of short, hair-like growth; and small clumps of debris (up to about 1 inch in length) hanging from the body or fins of the fish. These growths may be white, or they may take on the color of any suspended material in the water. Microscopic examination reveals branched fungal strands (hyphae) that can be seen at 30X (Figure 13.2).

Management practices that minimize stress and prevent mechanical damage to the fish will lessen the chance of external fungal infections which are secondary invaders that can be

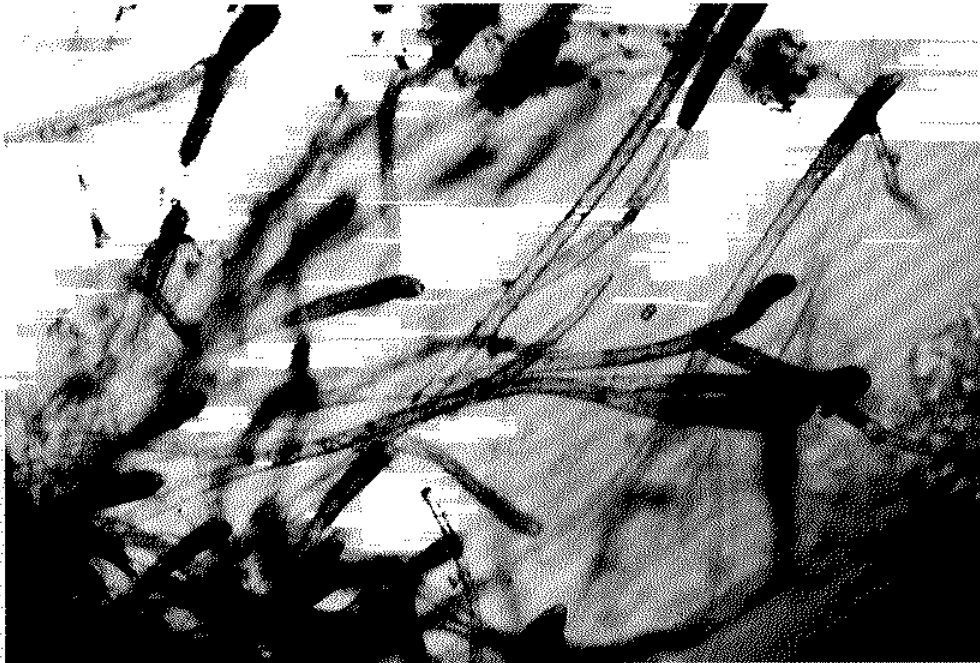

Figure 13.2. Microscopic view of fungus from fish. Photo Credit: A. J. Mitchell.

controlled effectively only if the primary cause of the fungal problem is identified and corrected. If the primary cause is identified and corrected, then a single pond treatment of 2 ppm potassium permanganate gives excellent results; however, if the red color imparted to the water by the potassium permanganate changes to a yellow-brown in less than 10 hours, due to a high permanganate demand by the organic load, the treatment must be repeated to be effective. In tanks or raceways, a 10-hour bath treatment of 2 ppm potassium permanganate is an effective treatment.

One of the authors (J. S. Hughes, unpublished data) has had excellent success in preventing and controlling external fungus infections on newly hatched striped bass and hybrid fry in feeding tanks using salt. She maintains the fry in water containing a minimum of 150 ppm of salt (sodium chloride) until they are stocked.

Systemic Fungal Disease

Branchiomycosis, or gill rot, is caused by a fungus, *Branchiomyces* sp., which occurs within the blood vessels of the gill filaments and lamellae. It has been reported one time from striped bass (Meyer and Robinson 1973), and rarely from other fish species in the U.S. In Europe and Asia, where it is common, it has been associated with waters high in organic content, with water temperatures of 68°F or more, with un-ionized ammonia levels of 0.1 ppm and higher, and with the rearing of ducks in fish ponds. *Branchiomyces* destroys gill tissue by blocking the flow of blood in the gill capillaries. Mortality rates are usually high.

Microscopic examination of gill tissue is necessary for diagnosis. Finding non-septate hyphae that measure 8-30 μm long by 9-12 μm in diameter in the gill blood vessels is diagnostic for branchiomycosis (Figure 13.3).

There are no known effective chemical treatments, and the only management practice is to maintain good water quality and sanitation in the rearing facilities.

Parasitic Diseases

Protozoan Parasites

Amyloodinium ocellatum is a serious ectoparasite of striped bass raised in brackish water having a salinity over 3 ppt. This protozoan parasite is found primarily on the gills where it attaches by means of a rhizoid and causes a breakdown of the branchial tissue (Figure 13.4). Affected fish are listless and reduce or stop feeding. When it occurs on the skin, it causes a lesion which has a velvet-like sheen, resulting in the name "velvet disease" sometimes being used, and the fish may "flash." Prevention is best accomplished by using a source of water that is free of wild fish, and by not bringing in infected fish.

Lawler (1977) reported good control of *Amyloodinium* by dipping fish in fresh water for 2-5 minutes, but stated that it must be done several times for best results. There is much disagreement about the effectiveness of copper sulfate as a control for *Amyloodinium*, but Johnson (1987) reported excellent results in controlling it on redfish by using a chelated copper

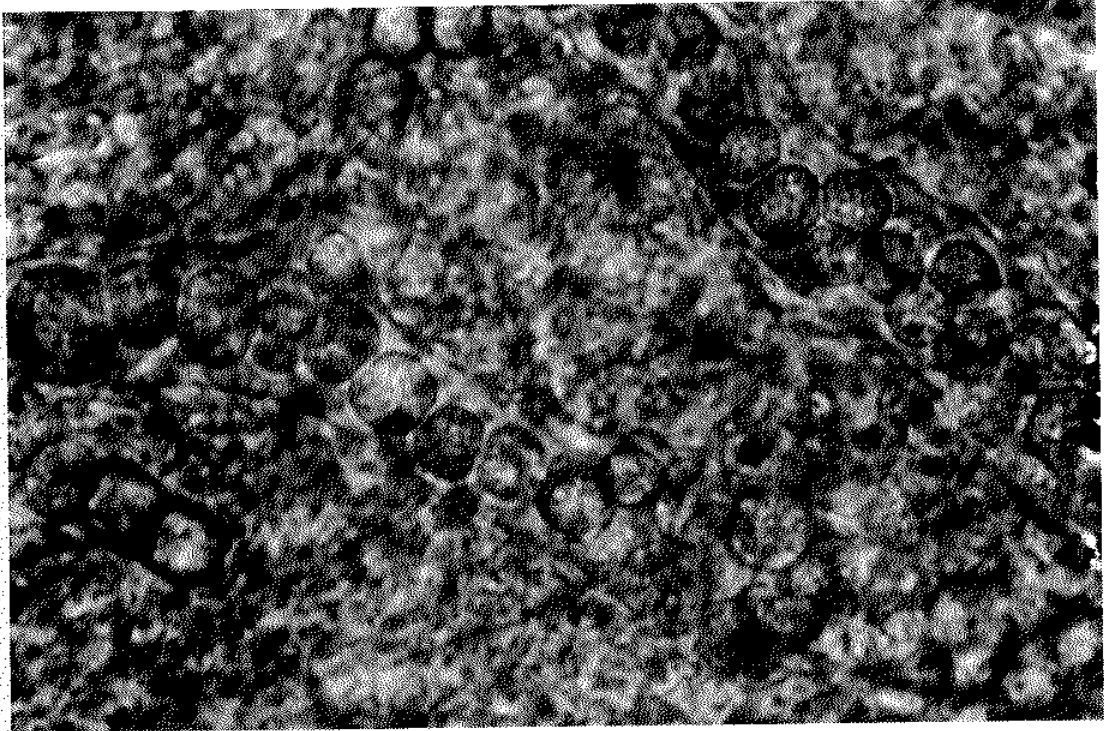

Figure 13.3. *Branchiomyces* — Fungal hyphae in capillaries of branchial tissue. Photo Credit: G. L. Hoffman.

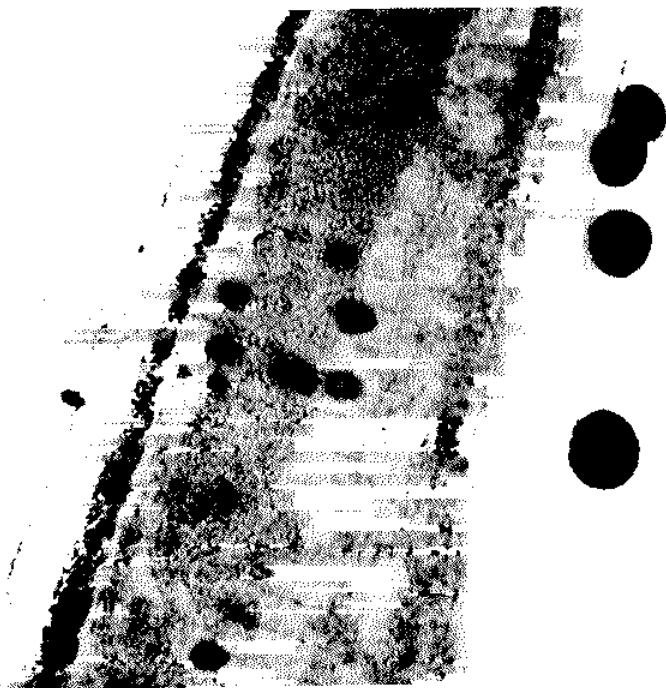

Figure 13.4. *Amyloodinium* on gill filament. Photo Credit: R. L. Thune.

compound (Cutrine®) at either 2 or 6 ppm. Minton (1985) used a commercial chelated copper compound (8.5% active elemental copper) at either 4 or 6 ppm to treat infected striped bass, and totally eliminated *Amyloodinium* in 96 hours. Benzalkonium chloride, used as a 1 ppm indefinite bath and then repeated two days later, completely eliminated *Amyloodinium* from sciaenids (Johnson 1987). *None of the compounds mentioned as a treatment are legal to use on striped bass reared for human consumption.*

Ich disease, caused by the ciliated protozoan *Ichthyophthirius multifiliis*, is not common, but is devastating when it occurs. Clinical signs of ich disease include: small, well-defined white spots on the skin and fins which merge into irregular, light-colored patches as the disease progresses; flashing; reduced or no feeding; and pale and puffy gills. Occasionally, ich may be almost totally restricted to the gills.

The white spots are not diagnostic because several other diseases may cause similar lesions. An accurate diagnosis can be made only by a microscopic examination of gill tissue or skin scrapings and finding the large (100-1,000 μm), uniformly ciliated protozoan, which has a large horseshoe-shaped macronucleus, in the tissue (Figure 13.5).

The life cycle of ich is complex and involves the adult form (trophont = trophozoite) burrowing out of the skin or gills of the fish, becoming free-swimming for a short period of time, and then encysting prior to reproduction by multiple fission. After reproduction is complete,

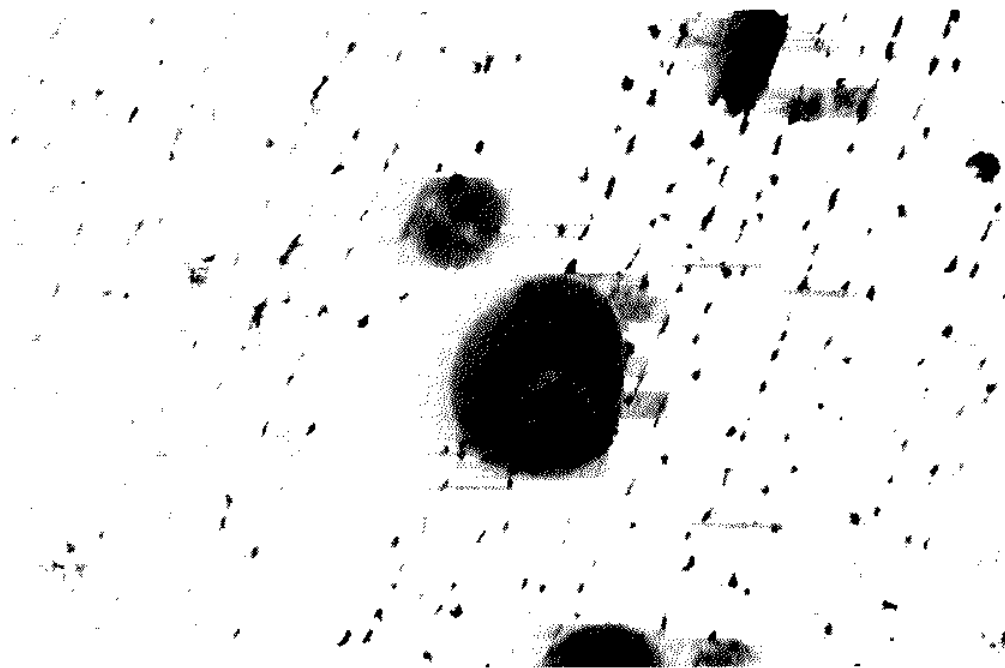

Figure 13.5. Ich on fin of fish. Photo Credit: F. P. Meyer.

the cyst ruptures, releasing the free-swimming infective stage (theronts = tomites). The theronts begin to actively seek a new host, which they must do within 96 hours or they will die. Ich usually occurs when water temperatures are less than 82°F.

To prevent the introduction of ich, do not use water that contains a wild fish population for your facility, and do not stock fish from other sources without putting them in quarantine for at least two weeks.

Treatment of ich is difficult because of the complex life cycle; only the free-swimming forms are susceptible to chemical treatments. Multiple treatments must be used, and may be of limited or no benefit unless the outbreak is caught early and treatment started immediately. Copper sulfate, used at a safe rate as an indefinite treatment and repeated every other day, does a good job of controlling ich; usually three to five treatments are required. Although expensive, potassium permanganate and formalin, used as indefinite pond treatments and repeated every other day three to five times, will give good control. Putting ich infected fish in water with a salinity of 10 ppt or greater for seven days or longer, depending on temperature, is also an effective control (Allen and Avault 1970). Any ich infection will result in some losses, and if there is any delay in starting the treatment, the losses can easily reach 90 to 100%.

Epistylid infections, caused by members of the genera *Heteropolaria* and *Epistylis*, can cause problems in striped bass cultured in fresh water. They are ciliated protozoan parasites found on the skin, fins, and gills of fish. Epistylid problems are usually more common during the summer in waters with high organic content, although they can occur throughout the year.

Epistylid lesions on infected fish appear as short, slimy, fungus-like growths that cover small to large areas of the body surface and fins. Hemorrhagic areas often occur at the attachment site of the epistylid stalks. The organism also infects the gills, causing hyperplasia and necrosis of gill epithelium.

An accurate diagnosis requires a microscopic examination. Epistylid trophozoites often have an inverted bell-shape and are attached to a dichotomous stalk (Figure 13.6). To prevent epistylid infections, avoid introduction of infected fish into the culture system, and maintain good water quality and sanitation.

Epistylids are best controlled with a 1-10 ppt salt bath. Good results have been achieved using a 15 ppt salt bath for 3 hours, followed by flushing (Foissner et al. 1985). They are extremely difficult to control with copper sulfate, formalin, or potassium permanganate, but in ponds, potassium permanganate at 2 ppm provides some relief (T. L. Wellborn, unpublished data).

Trichodinid infections on striped bass are caused by a number of species. Most often these are referred to as *Trichodina* spp., but members of the other closely related genera may also be involved. They occur on the gills, fins, and skin of striped bass reared in fresh water (Figure 13.7). Low numbers of trichodinids on striped bass and hybrids 1-2 inches long, while



Figure 13.6. *Epistylis* from fins of fish. Photo Credit: G. L. Hoffman.

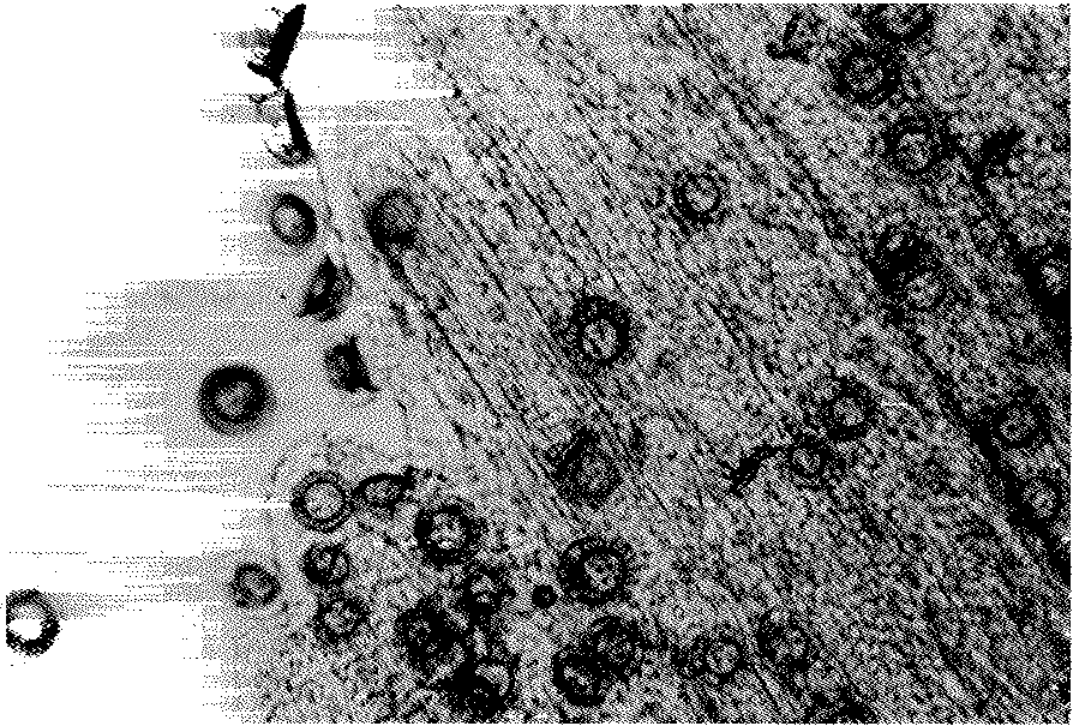

Figure 13.7. *Trichodina* on fish fin. Photo Credit: A. J. Mitchell.

not causing direct losses, weaken the fish such that they are very difficult to handle without losses (J. S. Hughes, unpublished data). They reproduce by binary fission or conjugation; therefore, their numbers can increase rapidly and cause serious losses. Trichodinids are a more serious problem on young fish, but adults can also be affected. These organisms are more of a problem in the spring and fall, but can cause losses anytime of the year.

Physical and behavioral signs caused by trichodinids are variable and include: flashing; lethargy; aggregation around inflowing water and in shallow water; small bloody spots (petechiae) on the skin and fins; a bluish-gray slime on the body; gills pale and puffy; and they may appear as if they were suffering from low oxygen even though oxygen levels are adequate. An accurate diagnosis can be made only by finding the parasite in a microscopic examination of skin scrapings and gill clippings. Trichodinids are small, disk-shaped ciliates with a supporting denticular ring that can be seen at 100X.

Prevention is best accomplished by treating all fish prior to stocking in your facility, and by not using surface water that contains wild fish populations.

Trichodinids are easily controlled with a safe concentration of copper sulfate, potassium permanganate, or formalin. If small striped bass and hybrids that are infested with low numbers of trichodinids are treated prior to harvest, they will handle very well (J. S. Hughes, unpublished data).

Other protozoan parasites that can cause losses have been reported from striped bass. These include: *Ambiphrya* (*Scyphidia*), *Ichthyobodo* (*Costia*), and *Trichophrya* (Figures 13.8-13.10).

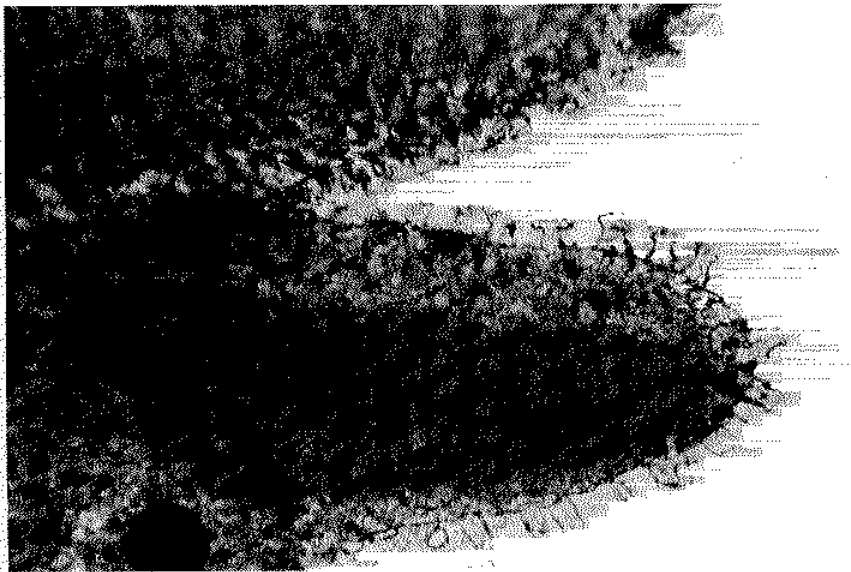

Figure 13.8. *Ambiphrya* (*Scyphidia*) on gills of fish. Photo Credit: G. L. Hoffman.

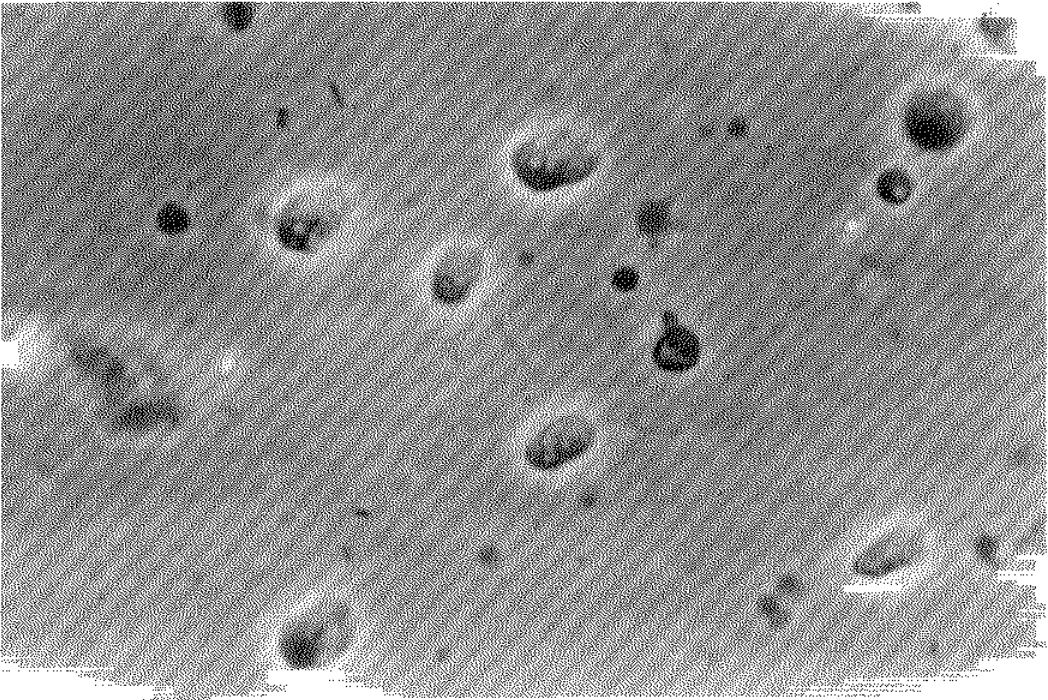

Figure 13.9. *Ichthyobodo* (*Costia*) from gills of fish. Photo Credit: A. J. Mitchell.

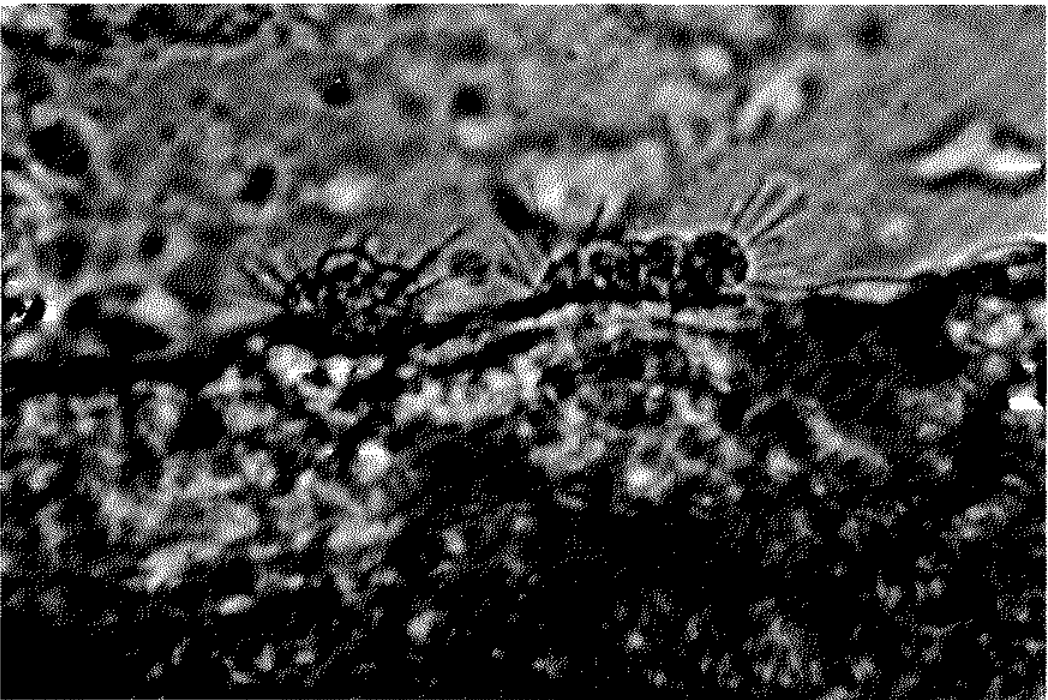

Figure 13.10. *Trichophrya* on gills of fish. Photo Credit: A. J. Mitchell.

All of these are ectoparasites on the gills and skin, except for *Trichophrya* which is found only on the gills. These parasites block, thicken, or break down the branchial tissue and compromise the integrity of the skin. However, except for fry, large numbers are required to kill fish. Low numbers of *Trichophrya* can make small striped bass and hybrids very difficult to handle without sustaining losses. If *Trichophrya* infested fish are treated prior to harvest, they are easy to handle and losses seldom occur (J. S. Hughes, unpublished data). Identification of these parasites can only be confirmed microscopically.

As with most parasites, conditions such as malnutrition, poor water quality, crowding, and fluctuating temperatures in the spring and fall seasons predispose the fish to the protozoan epizootics. Prevention, by minimizing stress, is the first line of defense.

Treatment with copper sulfate, potassium permanganate, or formalin is effective against these parasites, with the exception of *Trichophrya*, which must be treated with copper sulfate. The concentration used depends on the total alkalinity of the water.

Monogenetic Trematodes

Four genera of monogenetic trematodes (*Diplectanum* sp., *Gyrodactylus* sp., *Microcotyle* sp. and *Urocleidus* sp.) have been reported from striped bass and hybrids. Of these only one, *Gyrodactylus* sp., occurs on the skin (Figure 13.11); the other three parasitize the gills. Monogenetic trematodes seldom cause problems in striped bass, and usually only in young fish. Few clinical signs are associated with monogenean infestations, except that *Gyrodactylus* sp. will cause fish to flash, and there may be petechial hemorrhages on the fins and skin. Gill

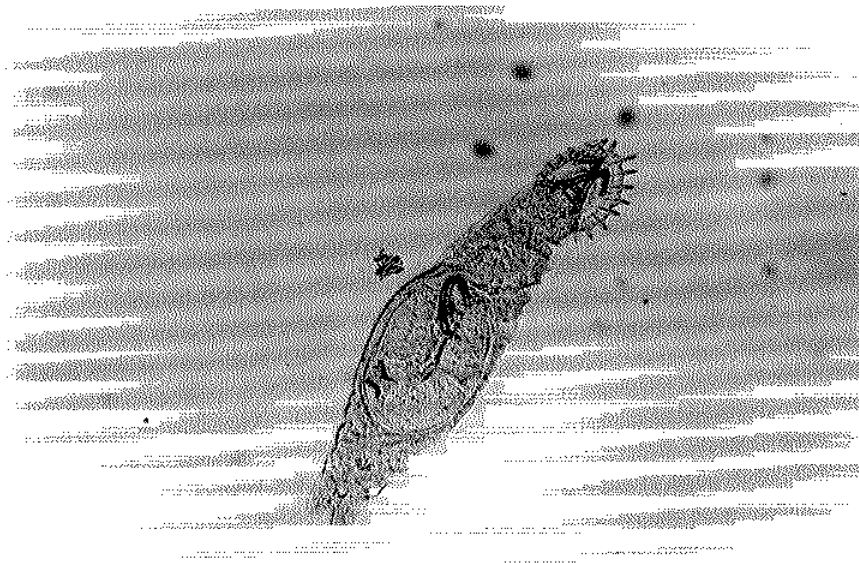

Figure 13.11. Monogenetic Trematode — *Gyrodactylus*, three generations appear in this photo. Photo Credit: G. L. Hoffman.

flukes, if present in large numbers, may cause flared opercula, and affected fish tend to aggregate around inflowing or in shallow water.

Any type of stress may predispose fish to infection by these flukes. Problems caused by monogeneans usually occur in the fall, winter, and spring. Diagnosis must be made by microscopic examination. Masoten, copper sulfate, formaldehyde, and potassium permanganate are effective treatments when used at safe concentrations. It may be necessary to repeat the treatment.

Digenetic Trematodes

Intense infections with the digenetic trematodes *Clinostomum complanatum* (yellow grubs) or *Posthodiplostomum minimum* (white grubs), although not common in striped bass, can cause serious problems (Hoffman and Hutchinson 1970). Both these grubs have a complex life cycle involving snails, fish, and birds. For a serious problem to occur, the parasite, a large number of snails (the first intermediate host), birds (the definitive host), and susceptible fish (the second intermediate host) must all be present at some time.

On rare occasions, fish have been parasitized with massive numbers of larval digenetic trematodes, resulting in high losses. Massive white grub infections in fish, although very unusual, can cause bloated bellies and exophthalmia (popeye), which occasionally causes death. Vital organs are displaced, and occasionally the abdomen can rupture. When the abdomen is opened, hundreds of white particles, the grubs, about the size of sugar granules flow out in a clear fluid.

The free-swimming infective stage (cercaria) of the yellow grub is released from infected snails, penetrates the skin of fish, and migrates through various tissues (including vital organs) to reach their preferred site, muscle tissue. If the fish is not killed by the migration through vital organs, the grubs will develop in the muscle tissue and may appear as a number of yellow to white bumps (3-7 mm long) under the skin of the fish. Positive identification can only be accomplished microscopically.

Because there is no chemical treatment for digenetic trematodes, efforts must be directed to prevention by managing bird and snail populations. Snails can be partially controlled by draining, drying, disking and liming of pond bottom with 1,000-2,000 pounds of hydrated lime per acre. If any water is left in the pond, two or three treatments of copper sulfate at 10 ppm or more will reduce the snail population, but will also kill any fish left in the pond. Bird control must be done in cooperation with state agencies and with the U.S. Department of Agriculture (USDA) and the U.S. Fish and Wildlife Service (USFWS), because most problem birds are migratory and are protected by federal law. Assistance is available to scare birds away, and depredation permits to kill a limited number of birds can be issued by the USDA.

Diplostomum flexicaudum, the eye fluke, has caused problems in striped bass at a federal fish hatchery in North Carolina (Figure 13.12). It caused no losses, but did result in severe exophthalmia (popeye) because of the large numbers in the eye. The life cycle of the eye fluke is

similar to that described for the yellow and white grub. Prevention and control methods are the same as for the yellow and white grubs.

Several other genera of adult and larval digenetic trematodes have been reported from striped bass, but none of them have caused any problem.

Nematodes

Goezia sp., a nematode, caused mortalities in striped bass at a Florida fish hatchery (Gaines and Rogers 1972). The fish became infected after being fed ground raw herring containing the larval parasite. It parasitized the intestinal wall, killing several fish. *Goezia* sp. evidently cycled in the lake and killed several striped bass the next year. It was also found in another of the lake's fish, *Tilapia aurea*. This problem can be avoided by not feeding raw fish.

Other nematode genera found in striped bass include *Cucullanis*, *Philometra*, and *Spinitectus*. None have been implicated in causing a problem.

Acanthocephalan Parasites

Although acanthocephalans (spiny-headed worms) are not reported as a problem in striped bass and hybrid culture, heavy infestations of adult *Pomphorhynchus laevis* are common in the intestine of brood fish caught in Atlantic coastal waters. Obviously, *P. laevis* damages the intestine (Figure 13.13), but what impact they have on individuals or populations of striped bass is not known. There is no approved treatment for acanthocephalans.

Crustacean Parasites

Ergasilus spp. have the potential to cause a problem in striped bass culture. They appear as small white specks on the gills, and occasionally cause mortality (Figure 13.14). *Ergasilus*

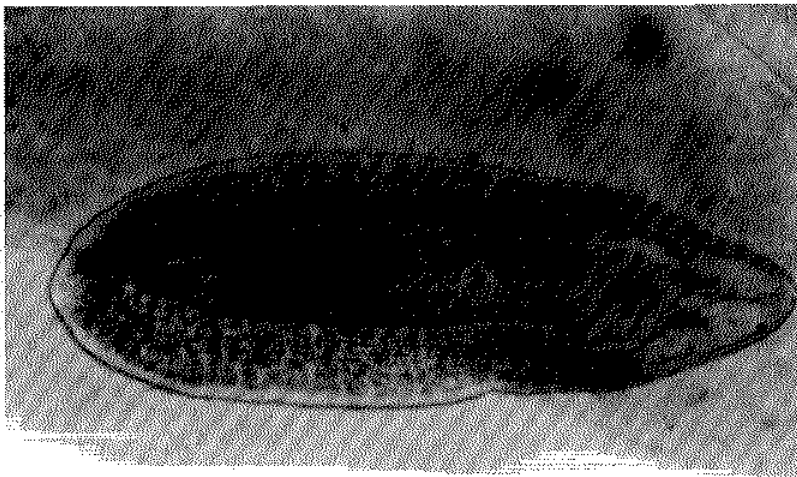

Figure 13.12. Digenetic trematode — eye fluke in fish. Photo Credit: A. J. Mitchell.



Figure 13.13. Acanthocephalans *Pomphorhynchus* on striped bass. Photo Credit: T. L. Wellborn.



Figure 13.14. *Ergasilus confusus* on gill of fish. Photo Credit: T. L. Wellborn.

epizootics can occur wherever striped bass are cultured in fresh water. Microscopic examination is necessary for diagnosis. *Ergasilus* has two distinctive hook-like "arms" by which it clasps a gill filament.

Prevention is best accomplished by stocking *Ergasilus*-free fish and by using a source of water free of wild fish. Masoten, used at 0.25 ppm active ingredient, is an effective treatment.

Other parasitic crustaceans reported from striped bass include *Achtheres*, *Caligulus*, *Argulus*, and *Lironeca*.

Chemical Treatments

Many different chemicals and drugs have been used in the treatment of fish diseases, but only those that are commonly used for striped bass culture and are economically feasible will be discussed.

Listing of these drugs and chemicals in no way implies our recommendation for their use, nor does it imply that they have been approved for use by the U.S. Food and Drug Administration (FDA) or the Environmental Protection Agency (EPA). For safe, effective, and legal application of chemicals, follow labeled instructions. An individual planning to treat fish is responsible for the proper use of a specific drug or chemical. Schnick (1988) provided a list of approved therapeutants for use in fish culture; however, because the approval status of chemicals can change, FDA should be contacted for a current listing.

Copper Sulfate

Copper sulfate (bluestone) is an old and widely used fish culture chemical and is considered to be 100% active. It is registered for food fish use as an aquatic herbicide. Copper sulfate has wide application for use in aquatic environments as an algicide and as an effective control for a variety of protozoan ectoparasites, such as *Trichodina*, *Ichthyobodo* (*Costia*), *Trichophrya*, *Amphiphrya* (*Scyphidia*) and ich. Copper sulfate is generally used as a pond treatment. It has one serious drawback: the toxicity of copper sulfate to fish varies depending on the total alkalinity of the water.

To determine the amount of copper sulfate that can be safely used, divide the total alkalinity of the water (expressed in ppm of CaCO_3) by 100. The answer is the maximum concentration (in ppm) of copper sulfate to use. If the total alkalinity is less than 50 ppm, a bioassay should be run to determine the effective concentration needed. If you cannot determine the total alkalinity of the water, either do a bioassay to find a safe, effective concentration, or use another chemical. Do not use the total hardness to try to calculate a safe rate since it has little or no effect on the toxicity of copper sulfate. In water with a total alkalinity 300 ppm or greater, copper sulfate should not be used because it will precipitate as insoluble copper carbonate and will be ineffective. Do not depend on previous alkalinity measurements if runoff, rain, or well water has been added; take a new measurement.

Chelated copper solutions, such as Cutrine[®], are more effective than copper sulfate in waters with high total alkalinity. Recommended application rates and safety precautions for these solutions are given on their labels.

Masoten

Masoten (Dylox) is usually obtained as an 80% wettable powder (W.P.). It is registered for non-food fish use as a parasiticide; it is not registered for food fish. Masoten is generally used as an indefinite pond treatment to control ectoparasites, such as monogenetic trematodes, anchor parasites, *Ergasilus*, fish lice, and leeches at a concentration of 0.25 ppm active ingredient (0.84 pounds of 80% W.P. per acre foot).

One or two treatments are enough for monogenetic trematodes, leeches, and fish lice, but four treatments should be applied at 5- to 7-day intervals to effectively control anchor parasites.

Masoten breaks down rapidly at high water temperatures and high pH, so inconsistent results may be obtained with its use during the summer. In warm weather, applications should be made early in the morning for best results.

Formalin

Formalin (37-40% formaldehyde gas by weight in water) is considered to be 100% active for the purpose of treating fish. It is registered for food fish use as a parasiticide. Formalin is effective against many ectoparasites, such as *Trichodina*, *Ichthyobodo* (*Costia*), ich, and monogenetic trematodes. Formalin is widely used as a bath treatment at 125-250 ppm (4.4-8.8 mL per 10 gallons; 32.8-65.5 mL per 10 cubic feet) for up to one hour. Above 70°F, formalin becomes more toxic and the concentration should not exceed 167 ppm (5.9 mL per 10 gallons; 43.8 mL per 10 cubic feet). When using formalin as a bath treatment, the fish must be watched throughout the duration of the treatment in order to observe any signs of formalin stress that may begin to develop.

Aeration should be provided during treatment to prevent low oxygen conditions from developing. At the first sign of stress, add fresh water to flush out the treatment. As an indefinite treatment in ponds, tanks, or aquaria, formalin is generally used at 15-25 ppm (4.5-7.5 gallons per acre foot; 0.53-0.88 mL per 10 gallons; 3.9-6.6 mL per 10 cubic feet). Because formalin has the property of reducing oxygen concentrations at the rate of 1 ppm for each 5 ppm formalin used, it should be used with caution, particularly in summer months, to minimize the chance of oxygen depletion in the pond or tank.

Be sure to buy formalin that contains 10-15% methanol, and store it at temperatures above 41°F. The methanol acts as a preservative to help retard the formation of paraformaldehyde, a white precipitate that can be toxic to fish. Contaminated formalin can be filtered to remove the paraformaldehyde.

Potassium Permanganate

Potassium permanganate, registered for use on food fish as an oxidizing agent, is another chemical that is widely used in warmwater fish culture. It is 100% active, and is used to control external protozoan parasites, monogenetic trematodes, external fungus, and external bacterial infections. At 2 ppm, it is not toxic to striped bass, but above this concentration, potassium permanganate can be very toxic.

Potassium permanganate imparts a deep, wine-red color to water. As it breaks down (oxidizes), the color changes to a yellowish-brown. If this color change occurs in less than 10 hours after the potassium permanganate has been applied, it is necessary to repeat the treatment as near to the time of the color change as possible.

Sodium Chloride

Sodium chloride (salt) is registered for fishery (food fish) use as an osmoregulatory enhancing agent, and it is useful as a general therapeutic or prophylactic treatment, mainly because it increases mucus flow. It has been used against a few of the external protozoan parasites, mainly *Epistylis*, fish lice, and leeches. As a prolonged bath treatment, and for use in hauling tanks, it has been used at 1,000-10,000 ppm (1-10 ppt) (38-380 g per 10 gallons; 283-2,830 g per 10 cubic feet). An effective bath treatment for *Epistylis* is 15 ppt salt for 3 hours, then flush. As a dip treatment for leeches and fish lice, it has been used at 30,000 ppm (30 ppt) for up to 30 minutes, or until fish show signs of stress.

Terramycin®

Terramycin® (oxytetracycline) is a broad spectrum antibiotic that is widely used to control external and systemic bacterial infections in fish. It is available in many formulations, both liquid and powder. As a bath treatment in tanks, it is used at 15 ppm active ingredient (0.57 g active per 10 gallons; 4.25 g active per 10 cubic feet) for 24 hours. The treatment may have to be repeated on 2 to 4 successive days. It has also been used in hauling tanks at the same concentration. Where a smaller number of large or valuable fish are involved, Terramycin® can be injected at 25 mg/pound of body weight.

When it is necessary to administer Terramycin® orally, it should be fed at 25-38 mg active ingredient per pound of fish per day for 10 days. *A full 10 days of treatment is required to minimize the development Terramycin® resistant bacteria.*

Tolerance of Treatment Chemicals

The toxicity of chemotherapeutants tested on striped bass eggs, fry, fingerlings, and juveniles are given in Table 13.1. These chemicals are reported as 24- and 96-hour LC₅₀ values (50% mortality in designated time). Data included in this section should be used as a general reference, because water quality; size, age, and health of fish; and chemical formulations affect treatment rates. A small number of fish should be treated in the water before applying the chemical to an entire pond or tank of fish.

Table 13.1. Toxicity of chemicals to striped bass.

Chemical	Grade or % Active Ingredient	Active Ingredient	Size of Fish	LC ₅₀ (ppm)		Reference
				24 hour	96 hour	
Copper sulfate	Technical	Copper sulfate	Fry Fingerling Fingerling	0.75 0.4 1.5	0.1 0.15 0.62	Hughes 1971 Hughes 1971 Wellborn 1969
Cutrine	8.51%	Copper triethanolamine complex	Fry Fingerling	0.05 0.1 ^a	0.01 0.1	Hughes 1973 Hughes 1973
Dylox	80%	Dimethyl (2,2,2-trichlor-1-hydroxyethyl) phosphonate	Fry Fingerling	30.0 16.0	5.0 2.0	Hughes 1971 Hughes 1971
Dylox	50%	Dimethyl (2,2,2-trichlor-1-hydroxyethyl) phosphonate	Fingerling	10.4	5.2	Wellborn 1969
Formalin	Technical	Solution of 37%, by weight, of formaldehyde gas in water; 10-15% methanol added	Fry Fingerling Fingerling	15.0 35.0 86.0	10.0 15.0 18.0	Hughes 1969 Hughes 1969 Wellborn 1969
Potassium permanganate	Technical	Potassium permanganate	Fry Fingerling Fingerling	1.5 5.0 —	1.0 4.0 2.5	Hughes 1971 Hughes 1971 Wellborn 1969
Salt (Chloride)	Technical	Prepared from sodium chloride	Fry Fingerling Fingerling	3000.0 7000.0 4830.0	1000.0 5000.0 —	Hughes 1969 Hughes 1969 Tatum et al. 1966
Terramycin	22.3%	Oxytetracycline hydrochloride	Fry Fingerling	50.0 ^a 150.0	50.0 ^a 75.0	Hughes 1973 Hughes 1973
Terramycin concentrate	25.6 gm/4 oz.	Oxytetracycline hydrochloride soluble powder	Fingerling	—	165.0	Wellborn 1971
Terramycin Globe Pet Tabs	50 mg active/tablet	Oxytetracycline hydrochloride	Fingerling	250.0	178.0	Wellborn 1969

^a LC₀ (no mortality)

Overview and Considerations for Management of Striped Bass and Striped Bass Hybrids

Ronald E. Lewis, Terry E. Cheek, Fred D. Leckie, Jr.,
Roger L. McCabe, Jerry L. Moss, and Gregory L. Summers

The management of any fish species cannot be condensed into a few pages. Individual species and each situation requires a specific approach. While this chapter does not give details needed for the total management of striped bass (*Morone saxatilis*) and hybrids, an outline of necessary considerations for managers is provided.

Striped bass have received considerable attention throughout the United States following the discovery by Scruggs and Fuller (1954) that a landlocked population impounded in Santee-Cooper Reservoir, South Carolina, had spawned and become successfully established. Attempts to establish striped bass populations in other Southern reservoirs by introduction of adults were unsuccessful (Bailey 1975), as were later attempts with introductions of striped bass fry.

The development of culture methods to rear striped bass and striped bass hybrid fry to fingerlings enabled establishment of *Morone* fisheries in inland lakes, rivers, and coastal systems. Axon and Whitehurst (1985) reported that 30 state fisheries agencies stocked striped bass or striped bass hybrids during 1981. Smith and Reeves (1986) reported that of 50 state game and fish agencies contacted by telephone, 19 state agencies stocked striped bass and 26 states stocked striped bass hybrids. Development of *Morone* fisheries of these agencies included a variety of objectives:

1. establishment of an additional sport fish
2. increase of trophy fish potential
3. utilization of abundant forage populations
4. utilization of available habitat

5. maintenance of broodstock sources
6. reduction of fishing pressure on other heavily exploited populations
7. restoration and enhancement of marine stocks (Axon and Whitehurst 1985; Moring 1986)

Evaluation of Introduction

Pre- and post-stocking evaluations should be an integral part of any fisheries management program. As demand for striped bass and hybrid fingerlings for stocking increases, fishery managers will have to evaluate establishment of new and continuation of existing *Morone* fisheries. Murphy and Kelso (1986) suggested that a stocking evaluation should address:

1. biological characteristics of target fish populations, such as survival, growth, and reproduction
2. social and economic characteristics of the angling public
3. program benefit, cost ratios
4. additional factors such as genetic mixing of stocks, competition, movement, disease introduction, habitat modification, and predator-prey interactions

Consideration of these factors may best be accomplished by literature review and development of quantitative management objectives for critical evaluation.

Stocking Considerations

Communication and application of current knowledge by fish culturists and management biologists can improve survival and growth of stocked fish. Most commonly, striped bass and hybrid striped bass are stocked at 1- to 2.5-inches (phase I fingerlings). Where food availability and predation might be a problem for phase I fish, introduction of 3- to 10-inch phase II fingerlings may be necessary to establish a fishery. Stocking rates for striped bass fingerlings vary from 1 to 50 fish per acre (Smith and Reeves 1986), while the most common rates reported for hybrid striped bass fingerlings range from 5 to 20 fish per acre. Selection of striped bass, hybrids, or a combination of both is generally influenced by physicochemical, biological, or often sociological considerations.

Physicochemical Factors

Physicochemical conditions of water bodies can limit striped bass and hybrid management objectives. A nationwide survey of state fisheries agencies in 1981 identified factors limiting striped bass and hybrid management with high temperature stress and low dissolved

oxygen concentrations being the most frequently listed factors affecting survival of adult striped bass (Axon and Whitehurst 1985). Reservoirs having water temperatures less than 77°F with dissolved oxygen concentrations greater than 5 ppm during the summer have produced excellent striped bass trophy fisheries (Coutant 1985b). However, in reservoirs where optimum growth and survival of adult striped bass appears curtailed by reduction or loss of summer habitat, striped bass rarely grow to over 11 pounds.

Hybrid fisheries have often been produced where attempts to develop striped bass fisheries failed (Axon and Whitehurst 1985). As of 1981, striped bass fisheries were established in 80% of the mesotrophic and oligotrophic lakes, and 50% of the eutrophic lakes stocked in the United States (Axon and Whitehurst 1985). In comparison, hybrid fisheries were established in 78% of the eutrophic, 46% of the mesotrophic, and 67% of the oligotrophic lakes stocked. Other physicochemical considerations include water body size, morphometry, and hydrology.

Spillway escapement, high discharge rates, and extreme water level fluctuations have been reported as problems which allow striped bass and hybrid emigration from impoundments (Axon and Whitehurst 1985). Matthews (1985) noted that reservoirs reported to have summer die-offs of striped bass had either greater mean values for surface area, volume, maximum depth, or depth of water release than those without striped bass mortalities.

Biological Factors

Forage availability often is a limiting factor with respect to establishment or maintenance of striped bass and hybrid fisheries. Inadequate populations of forage fish (primarily clupeids) can result from winter kills, poor primary productivity, or predation by striped bass, hybrids, and other predators. Predation on trout by striped bass has been a problem in several lakes having a "two-story" trout fishery.

Genetic conservation of defined striped bass stocks is a concern (see Chapter 11). With the reduction of coastal stocks of striped bass and increasing demand for stocking nationally, consideration must be given to maintain genetic integrity of natal stocks.

Reproductive success of striped bass females may be diminished because of reduction of cool water summer habitat (Coutant 1987). Thus, selection of brood fish for stocking programs as well as natural reproduction could be influenced by loss of habitat such as summer refuges.

Sociological Factors

When establishing a striped bass or hybrid fishery, geographical location with respect to user groups should be considered. Education of the user groups may be needed to develop angling skills for striped bass and hybrids. How-to workshops or seminars may be required to show anglers how to catch and release striped bass or hybrids (Harrell 1988). Publicizing information that addresses fishermen's concerns (i.e., the perception of displacement of largemouth bass and crappie) should be considered. Commercial and recreational conflicts may also need to be addressed (i.e., collection of brood fish for aquaculture, competition for coastal stocks).

Management Objectives and Options

Development of quantitative management objectives, such as a cost:benefit ratio, specific catch rate, harvest rate, or contribution to total fish yield, are needed for critical evaluation of culture and introduction programs. Several options may be used by fishery managers to meet management objectives. For instance, Weithman (1986) recommended the income-multiplier method for estimating benefits to state and local economies, and the travel-cost or contingent-value methods to estimate consumers' surplus for net benefit to anglers. Current regulations such as creel limits, size limits, seasons, or sanctuaries can be modified to meet specific harvest objectives. Likewise, natural reproduction of striped bass may be enhanced by manipulation of water flow regimes, protection of summer refuges, and improvement of water quality. Setting creel and size limits, supplemental prey stocking, manipulation of *Morone* stocking densities, and alteration of environmental conditions may be necessary to produce a trophy fishery.

Development of various genetic stocks of *Morone* spp. best suited to specific environmental conditions may eventually be a management option. Population and bioenergetic models may be useful for selection of management options (Dunning and Ross 1986; Hewett and Johnson 1987), but some form of site-specific inventory will probably be required to evaluate and make final decisions concerning appropriate options.

The Culture of Striped Bass and Hybrids in Brackish Water

R. Vernon Minton and Reginal M. Harrell

Egg Incubation

Striped bass (*Morone saxatilis*) eggs have been successfully incubated in salinities up to 5 ppt (Minton 1983; Harrell 1987), while salinities of 10 ppt or greater can cause indentations on the chorion (Mansueti 1958) and the eggs generally do not water harden (R. M. Harrell, unpublished data). In areas where low salinity surface water is used to incubate eggs or rear larvae, closed recirculating systems should be utilized whenever possible to avoid salinity and temperature fluctuations.

Several biological filtration systems have been successfully used in closed systems for striped bass and hybrid egg incubation; therefore, the system described here is presented solely as an example of one system currently in use. As with most systems, the physical layout of the culture facility will dictate the type of system that can be used.

In Alabama, at the Claude Peteet Mariculture Center (CPMC), the closed system currently in use consists of two adjacent concrete vats, each 25 x 4 x 3 feet. One vat contains the filtration media and the other contains the system water. The filter system was constructed by placing a series of fiberglass sheets (4 x 11 feet) on top of concrete blocks. A continuous roll of 1.0 mm nylon screen was placed on top of the fiberglass sheets, and a 2.5-inch layer of crushed oyster shell (washed to remove the fines) was added on top of the nylon screen. A sump, constructed of wood, is located at the drain-end of the submerged filter. A 2.0-hp electric centrifugal pump is used to lift water from the sump to an elevated trickle filter consisting of a fiberglass tank (2.5 feet deep x 4 feet diameter) filled with 4.2 cubic feet of media (Acrifil, Norton Chemical Co.). Water exits the fiberglass tank through a bottom drain and flows by gravity to the aquaria. Standpipes in each aquaria are screened with 160 μm Nitex[®] screen (or equivalent) and provided with a bubble screen to prevent impingement of fry. Water returns from the aquaria to the water holding vat via 5/8-inch latex tubing inserted into a 4 inch polyvinyl chloride (PVC) drain pipe. It is then siphoned from the holding vat and returned to the filter vat with two 2-inch and one 4-inch diameter PVC pipes.

Temperature regulation is accomplished by over-sizing an external air-conditioning unit. All duct work is constructed of fiberglass or other non-metallic material to prevent corrosion or ionization resulting from contact with salt water. The unit should be sized to regulate air temperature at $\pm 20^{\circ}\text{F}$ on a single pass through the unit, without recirculating the air. Air circulated within the system will contain enough salt to destroy the condensing coils within a couple of years.

Because salinities and temperatures in which brood stock are held may vary from those utilized for egg incubation, it is usually necessary to slowly acclimate the eggs to the system. If the eggs come from another facility, the transport bags should be floated in the system water until temperatures equilibrate. They are then gently poured into modified MacDonald hatching jars for incubation. Water flow to the jars should be maintained between 150-250 mL per minute during acclimation to the salt water. Eggs produced and water hardened in fresh water will float in the salt water due to specific gravity differences. As the salt water enters the jar from the bottom it will displace the fresh water which will move up and out ahead of the salt water. Personnel should mix the fresh and salt water by occasionally swirling the fill tube.

Most eggs, except Chesapeake Bay striped bass eggs, will remain slightly more buoyant when incubated in salt water, making metering of water into the jars more critical. A fine metering valve, such as a 0.5-inch Hayward needle valve, proves beneficial. Chesapeake Bay striped bass produce an egg that is positively buoyant. The addition of salt water during the water hardening process actually inhibits chorion expansion; thus these eggs are slightly less buoyant than the same eggs incubated in fresh water.

To minimize loss of water from the recirculating system, dead eggs are not carried out of the system as described in flow-through freshwater systems (see Chapter 5). Instead, small, fine mesh aquarium nets are positioned under the overflow of each hatching jar to catch dead eggs as they are washed from the jar. As with freshwater systems, eggs should be volumetrically enumerated after acclimation and 4-6 hours before hatch.

Water quality should be monitored within the system at least daily. Temperature, dissolved oxygen (DO), pH, salinity, CO_2 , and NH_3 , and $\text{NO}_2\text{-N}$ should be included as routine measurements.

Fry Culture

Due to probable salinity differences between the closed system and the ponds into which the fry are to be stocked, it is advisable to maintain the fry in the system for 7-8 days before stocking. This will allow time for the fry to develop osmoregulatory mechanisms necessary to accommodate salinity changes.

Feeding Larvae

Brine shrimp. At the initiation of feeding, brine shrimp (*Artemia*) nauplii should be added to each culture unit. Brine shrimp should be decapsulated using the procedure outlined

in Table 15.1 to prevent fouling problems, increase hatch success, and lessen potential problems with bacterial infections (Sorgeloos et al. 1977).

Nicholson et al. (1985) described an automatic feeder for delivery of the brine shrimp to the fry (Figure 15.1). This system uses solenoid operated valves set by a timer that allows release of a set amount of nauplii (volumetric release) at a desired frequency. If utilized, nauplii should be concentrated in the feeding cone to deliver the equivalent of at least 5 nauplii per mL in the culture system (aquaria) at 4 hour intervals on day 1 of feeding, 3 hours on day 2, and 2

Table 15.1. Decapsulation procedure of *Artemia* cysts to enhance hatchability and improve water quality currently in use at the Aquaculture Facilities at the University of Maryland Horn Point Environmental Laboratories (adapted from Sorgeloos et al. 1977).

-
1. Weigh 150 g cysts. Hydrate cysts (in tap water) in a 10-20 L carboy with aeration for 2 hours.
 2. Add 22.5 g NaOH in 1370-mL seawater — allow to dissolve.
 3. Pour hydrated cysts through a 120 μm sieve. Wash cysts with tap water for 1 minute and allow to drain.
 4. Pour NaOH solution into a round glass fingerbowl and scrape cysts into the solution. Add 710-mL bleach and stir (magnetic stirrer can be used).
 5. Observe the solution. A white foam layer should develop. The solution will change from brown to white to orange. This will require approximately 6 minutes. The cysts are decapsulated when there is no more color change.
 6. Pour the cysts back through the 120 μm sieve.
 7. Excessively wash the cysts with tap water for approximately 10 minutes. The chlorine smell should be gone.
 8. Scrape the cysts into the fingerbowl and pour enough 0.1 N HCL to wash the cysts for only 30 seconds.
 9. Pour the cysts back into the sieve and wash for 3 minutes with tap water.
 10. Incubate cysts in 100 L of seawater, according to the directions, overnight and harvest.
-

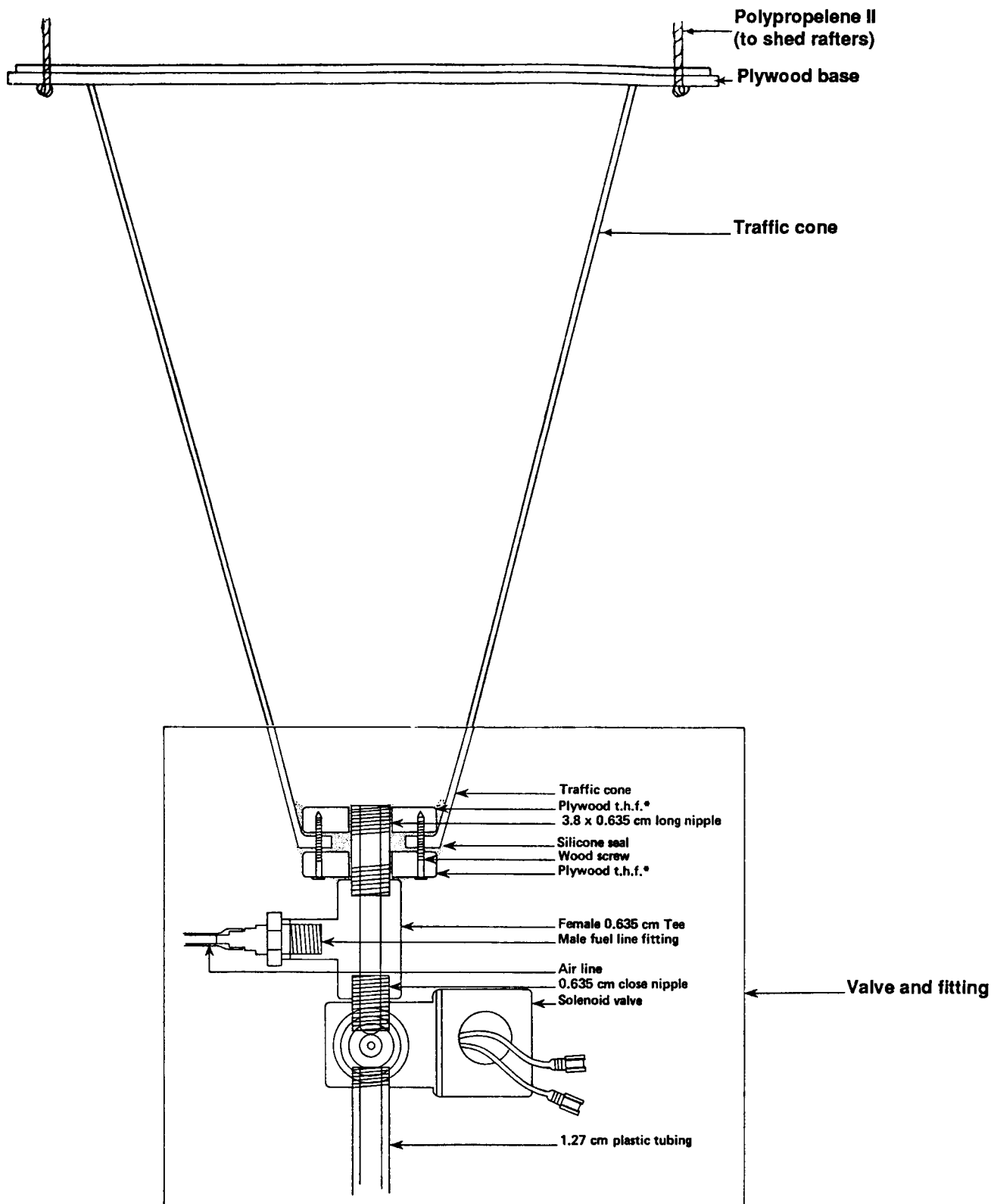

Figure 15.1. Low-cost automatic live food fish feeder; detail shows valve and fittings (from Nicholson et al. 1985).

hours on day 3. Hand feeding can accomplish the same result, but is much more labor intensive.

Rotifers. The marine rotifer *Brachionus plicatilis* has been utilized as a food organism in the production of marine fish larvae. This organism might be useful in the production of sunshine bass (white bass [*M. chrysops*] × striped bass). Several species of algae and rotifers tolerant of low salinities can be obtained for use in low salinity culture. The initial cultures utilized at the CPMC were isolated from earthen ponds containing brackish water by serial dilution and selective filtration. Culture units for rotifers were cone-bottomed cylindrical polyethylene vats or polyethylene plastic bags. Each unit was filled with 40 L of synthetic seawater (26 ppt). Temperature was maintained between 80 and 86°F. Rotifers were inoculated at densities of 40-60 per mL, cultured for 5 days, then harvested. Daily rotifer density and percent of females carrying one or more eggs was determined from total cell counts of 1 mL samples in Sedgewick-Rafter counting cells.

Stock cultures of unicellular green algae are grown in 4-L Erlenmeyer flasks containing double hole rubber stoppers which facilitate aeration and ventilation. Aeration was provided through a 4 mm airline tubing with an air stone attached to the terminal end. The flask was filled with deionized well water which was passed through an ion exchange column (Sybon-Barnstead No. d8904), and salinity was adjusted to 28 ppt with instant sea salts (Hw marine mix or Instant Ocean). After overnight aeration, nutrients from a modified Guillard's F/2 media were added.

A mass culture system developed at CPMC consists of ten 40 L plastic bags 20 × 36 inches × 6 mil thick (Minton et al. 1985). The bags are supported vertically from a central frame on a 8 × 3.5 foot plywood table coated with fiberglass. Continuous illumination is provided by six banks (two on each side mounted at a 45-degree angle and two directly above) of four 40-W cool white fluorescent (Sylvania gro-lux) lamps. The side banks are mounted 3.5 feet from the center of the bags and the overhead banks are mounted 3.5 feet from the top of the water line. Two banks of fluorescent lights (two lamps each) are positioned 7 inches behind and perpendicular to the bags. The pH in the bags and the Erlenmeyer flasks is maintained by injection of CO₂ from a compressed gas cylinder to the culture with dial timers and solenoid valves. Algae were harvested following 7-8 days of culture. Cell density usually ranged from 30-40 × 10⁶ cells/mL.

To minimize the consumption of algae, a dual culture system was developed. Rotifers were initially fed *Chlorella* spp., then inoculated into culture vats and fed primarily baker's yeast along with the algae. The algae were inoculated into 40 L polyethylene bags with nutrients and cultured alone for 2 days. On day three, rotifers were inoculated into the bag at approximately 30/mL. They were cultured from day 3 to day 5, then harvested to provide an inoculum for two 40 L culture vats and one 40-L bag. Because the desired inoculation was 50 rotifers/mL, and each culture unit contained 40 liters, there must be a minimum of 130 rotifers/mL. Rotifers from the algae culture bag were inoculated into the 40 L culture vats at 50/mL. On days 1 and 3 they were fed 2 L of high density *Chlorella* spp. (40-50 × 10⁶ cell/mL) and yeast at 1 g of yeast

per 6×10^5 algal cells; on days 2 and 4 they were fed yeast at 1 g per 6×10^5 cells. Cultures were fed a maximum of 20 g of yeast per day. Cultures normally averaged 700 rotifers/mL at harvest on day 5.

At harvest, the rotifers were sieved through a 60 μm Nitex® screen then re-suspended in 1-2 L of *Chlorella* spp. and 8 L of system water. They were held for 1 hour before feeding so that yeast, bacterial build-up, and metabolic wastes were depurated before introducing them to the larvae.

Rotifers were fed to the larvae using the procedures described for brine shrimp feeding. They were placed in feeding cones at a density to provide a feeding rate of 5 rotifers/mL every 2 hours. Delivery was timed to feed at 2.5 minute intervals. *Chlorella* spp. were also added to the cones to allow rotifers to feed until they were released into the larval tank; the nutritional quality of the rotifer was maintained by continuous feeding on algae. In addition, due to the rotifers being packed with the algae and its accompanying color, they are more visually evident to the larvae.

Maintenance of larvae. It is desirable to maintain fry in systems where the salinity is equal to or lower than that of the receiving waters because both fry and fingerlings are more easily acclimated from lower to higher salinities than the reverse.

Acclimation can be accomplished in two ways: at the pond bank or by culture unit water exchange. Pond bank acclimation is the less desirable because it is labor intensive and water quality problems can be encountered during the tempering process. Following enumeration, fry are siphoned into transport bags which are filled with pressurized oxygen, sealed, and transported to the ponds. The bags are floated in pond water until temperatures are equal before opening (see comments on stocking fry in Chapter 8). Salinity differences greater than 4 ppt are adjusted by slowly adding pond water to each bag.

If the culture building is equipped with filtered pond water and culture unit water, pond water may be added to exchange the system water. The exchange should be monitored to effect a salinity change of 2-3 ppt/hour. Return lines to the main system are removed to prevent contamination. Pond water should be monitored to maintain a salinity change of 2-3 ppt/hour. Because of the lengthy water exchange period, the fry should be fed during the acclimation process. If the ponds are close to the hatchery, fry can be transported directly and released into the ponds so bagging of fry is unnecessary. Concentrated fry can be siphoned into a 5-gallon plastic bucket and aerated with pressurized oxygen. Following transfer, lids are placed on the buckets and they are transported directly to the ponds, where they are opened and the fry poured into the deep end of the pond. All stockings, regardless of method, should be conducted after dark.

Phase I Fingerling Culture

Pond Fertilization

Fertilization of brackish water ponds to induce zooplankton production is accomplished in a manner similar to that used in fresh water (McCarty et al. 1986; Harrell and Bukowski 1990); therefore, with the exception of manures (see below), fertilization will not be covered in detail in this chapter (see Chapters 7 and 8). Both organic and inorganic fertilizers are utilized to establish a zooplankton bloom.

Because brackish water is usually (albeit not always with respect to alkalinity) better buffered than fresh water, manures have been used successfully. The rates of application have varied depending on the type of manure. At the CPMC in Alabama, chicken manure has been applied at 350 pounds per acre 10 days post-filling, with additional applications of 200 pounds per acre at approximately 7-day intervals. More recently, menhaden meal has been effectively used. Initial applications of 60 pounds per acre followed by 30 pounds per acre at weekly intervals have produced good zooplankton populations.

Zooplankton dynamics were discussed in Chapter 7; therefore, the ensuing discussion will focus on considerations of zooplankton encountered in brackish water. First, unless salinities are less than 5 ppt, cladocerans, and often the important freshwater cyclopoid copepods (i.e., *Cyclops* spp.), will not be encountered. The population will initially be dominated by rotifers with a gradual transition to calanoid and harpacticoid copepods. Similar to the fresh water recommendations, brackish water ponds should be fertilized using an aggressive fertilization schedule (see Chapter 7, McCarty et al. 1986, and Harrell and Bukowski 1990). Ponds should be initially fertilized and subsequently stocked 10-14 days after fertilization depending on whether the water source is surface or a salt water well source; the latter may require zooplankton inoculation. At the University of Maryland (R. M. Harrell, unpublished data), supplemental fertilization of 17 pounds per acre of soybean meal every other day, beginning one week post-filling, helped maintain extended populations of the copepod *Eurythemora* spp. in brackish water ponds (<15 ppt).

As in freshwater systems, water temperature affects the response of zooplankton population to succession. At temperatures of 66-68°F, approximately 2 weeks are required to develop appreciable populations, while at temperatures of 75-77°F good pre-stock concentrations were found by the end of week 1 (Minton 1983).

Survival of fry appears directly related to salinity and inversely related to temperature at the time of stocking (Table 15.2). Data from CPMC indicate that survival was better in years in which salinity was high and temperature was low (Minton 1980).

In Alabama, fry stocking densities from 200,000-500,000 fry per acre in brackish water have been evaluated in an attempt to optimize fingerling harvest with the higher densities appearing to be beneficial. The efficiency of food utilization also appears to be enhanced by stocking higher densities of fry. Although there is a reduction in the overall percent survival (Table

15.3), there is a substantial increase in the number of fingerlings recovered from each unit. Yet, as density and survival increase, the average size of the fish harvested decreases.

In similar phase I culture studies in South Carolina, Smith (1989) found striped bass and hybrids did well in brackish water (4-8 ppt) (Table 15.4) with survival as high as 75%. As in Alabama, the higher densities and survival usually resulted in smaller fish for a given culture period.

Table 15.2. Average production data per acre in brackish water ponds in Alabama 1975-1980.

Year	Date of Stocking	°C	Salinity ppt	Harvest Data number	weight	Survival %
1975	7 April	24.4	6	81,318	24.4	32.3
1976	15 April	17.2	9	64,806	15.8	24.8
1977	8 April	26.0	-	135,692	23.4	54.0
1978	18 April	22.0	10	136,897	55.6	57.0
1979	23 April	22.5	7	108,045	31.9	35.9
1980	22-26 April	25.6	0-2	61,860	18.5	19.1

Table 15.3. Average production data in brackish water ponds in Alabama 1975-1980.

Fry Stocked per Acre	Mean No. Culture Days	Mean Number Fingerlings	Standard Deviation	% Survival	Weight Harvested lb/ac	Number Fish per lb
200,000	38.0	63,000	26,860	24.9	38.5	1,636
275,000	43.5	29,000	10,970	11.1	26.4	1,098
375,000	36.0	71,000	13,930	19.0	43.0	1,651
500,000	38.6	84,000	40,215	16.4	58.4	1,438

Table 15.4. Results of phase I nursery trials with striped bass and its hybrids in brackish ponds (salinity 4-8 ppt) (from Smith 1989).

Type of fish	Stocking Data			Harvest Data		
	Density (No./ha)	Date	Duration (days)	Density (No./ha)	Survival %	Mean Wt (g)
Striped bass	600,000	04/28/87	30	281,630	46.9	0.36
F ₁ original hybrid	128,999	05/08/85	41	96,000	75.0	0.45
F ₁ reciprocal hybrid	300,000	03/10/86	57	74,500	24.8	2.20
F ₁ reciprocal hybrid	300,000	03/10/86	56	161,030	53.7	0.67

Striped Bass and Striped Bass Hybrid Culture: The Next Twenty-Five Years

Reginal M. Harrell, Jerome Howard Kerby,
Theodore I. J. Smith, and Robert E. Stevens

Tremendous growth and expansion have occurred in striped bass (*M. saxatilis*) and hybrid striped bass culture and management during the past 25 years. Increased stocking of inland and coastal systems, expansion of "put and take" recreational fisheries, establishment or enhancement of naturally reproducing populations, and restoration of threatened or declining natural populations, have all increased dramatically in recent years.

Declines in coastal stocks, which have traditionally supported commercial fisheries, have resulted in the development of a rapidly growing commercial aquaculture industry. In the United States, farmers constantly search for more profitable alternative forms of agriculture, and it has become apparent that aquaculture is a viable candidate. The future should find government and private industry working in concert to increase production, which will ultimately benefit both public and private fisheries.

Research will focus on nutrition, domestication of brood stock, evaluation of inland and private fisheries, strain selection, genetic manipulation through selective breeding, hybridization, polyploidy induction, possibly recombinant genetics, and production enhancement through reproductive and growth physiology. From a management perspective, the biological needs of the species, as opposed to social desires of the consumer, will be a major driving force for management of inland and coastal fisheries.

In the following sections, we will discuss specific areas that will receive particular attention in the next 25 years. The areas are by no means exhaustive, but they are areas where needs are already apparent.

Sustaining, Enhancing, and Restoring Estuarine Populations of Striped Bass

Sustaining the Populations

During the past two decades, substantial increases in recreational and commercial fishing, habitat alterations, and water pollution, have seriously reduced populations of striped bass in inland and coastal areas. Historically, fish populations have typically been managed by regulations that control seasons and restrict harvests. These regulations are the primary tool in all estuaries and inland systems that now contain striped bass. The most stringent regulations in history, including moratoria on harvesting striped bass, have recently been in effect in various coastal and inland systems (e.g., the Chesapeake and Delaware Bays). Large minimum size limits and restricted seasons are the rule elsewhere along the mid- and north Atlantic coasts. Likewise, inland fishermen are being subjected to reduced creels and implementation of, or increases in, minimum size limits.

In the San Francisco Bay, the daily creel limit has been reduced to two striped bass longer than 19 inches (total length), and commercial fishing was banned over 25 years ago. Similar measures in the Chesapeake Bay were designed to protect spawning adults with the expectation that sufficient reproduction would occur which would assure viable fisheries in the future. In the 1980s, a management strategy was adopted in the inland Santee-Cooper Lakes, South Carolina, that implemented an 18-inch minimum size limit and subsequently reduced the creel from 10 to 5 fish per day to increase harvest size and protect the spawning stock (M. G. White, South Carolina Wildlife and Marine Resources Department, personal communication).

Enhancing the Populations

For over a century, populations of many fish species have been established and enhanced through the practice of aquaculture. The best known examples are the Pacific salmonid stocking programs on the west coast where five salmonid species have been enhanced by stocking programs conducted by 300-400 state, federal, and private hatcheries.

Enhancement of estuarine populations of striped bass has recently been initiated (see Chapter 14 for comments on inland populations). It is believed that Gulf coast striped bass populations (which had declined precipitously by the late 1940s) were never as large or resilient as the mid-Atlantic populations. Initial stock enhancement efforts were begun in Mississippi in 1969. By 1986, almost 67 million fingerlings and 18 million fry had been stocked by Texas, Louisiana, Mississippi, Alabama, Georgia, and Florida (Nicholson 1986). Fishable populations have been restored in many areas, but natural reproduction has not reached a level that will sustain viable fisheries (R. V. Minton, Alabama Department of Conservation and Natural Resources, Marine Resources Division, personal communication).

In 1980 and 1985, stock enhancement efforts began in San Francisco Bay and Chesapeake Bay, respectively. Since then, 4.4 million advanced fingerlings have been released in San Francisco Bay and almost 2.8 million phase II fingerlings have been released in the Chesapeake Bay (C. M. Wooley, U.S. Fish and Wildlife Service, personal communication). Most fish stocked in

these locations were tagged, and many have been recaptured. Although it is too soon to evaluate the effect these efforts have had on stock enhancement, it is evident that hatchery fish are surviving and growing similar to marked wild fish.

We anticipate that striped bass hatcheries will not continue to be required to maintain fishable levels, as is the case with Pacific salmon. Hatcheries are expensive to build and maintain, and the practice can alter the gene pool; however, they provide a powerful tool for restoration and maintenance of viable populations of striped bass in inland reservoirs and in estuaries.

Role of State and Federal Agencies and Private Citizens

Regulations controlling utilization of natural resources are primarily promulgated and enforced by state governments. Every state with striped bass and hybrids has regulations pertaining to managing and harvesting these fish. Research is primarily within the province of the universities, while protection and management of the resource is under the purview of state and federal governments, although by necessity, the roles often overlap. For example, in the Chesapeake Bay, the U.S. Fish and Wildlife Service, in cooperation with the state of Maryland Natural Resources Department, is actively conducting a comprehensive stocking and tagging program for striped bass. While at the same time, the University of Maryland provides input on management decisions and undertakes research efforts to enhance production of hatchery-produced fish. Similar situations are found in other states. Likewise, many state and federal agencies are conducting research in areas such as population dynamics, water pollution, and aquaculture.

Federal laws, including the Lacey Act and the Atlantic Striped Bass Conservation Act, have been very useful in protecting and enhancing striped bass populations. In addition, the U.S. Fish and Wildlife Service has supported research to determine causes for the population declines in the Chesapeake Bay and for aquaculture. Many of the National Fish Hatcheries are involved in rearing striped bass fingerlings produced in state hatcheries which ultimately return to the state waters.

Strategies developed to restore estuarine populations of striped bass have been enthusiastically accepted by a sympathetic public. Will these programs succeed in the Chesapeake Bay and in San Francisco Bay? Will inland programs continue to grow? It is too early to tell, but the answers should be available within the next few years.

Goals and Direction of Research

The Future of Research

Research has been and will continue to be, an important component in striped bass and hybrid bass culture and management. There has been phenomenal progress made in *Morone* culture in the 25 years since the initial breakthrough in hormonal induction and prediction of striped bass spawning by Stevens and his co-workers (Stevens 1966, 1967; Stevens et al. 1965), and the demonstration by Anderson (1966) that striped bass could be successfully reared in

ponds. Knowledge gained from research by universities and state and federal agencies has resulted in: (1) enhanced management capabilities and creation of new recreational fisheries in inland lakes and reservoirs; (2) the ability of state and federal agencies to enhance threatened natural populations in coastal areas such as the Chesapeake Bay; (3) the inception of a new, high-value aquaculture industry; and (4) the ability to provide mitigation for industries that impact striped bass populations.

If progress in culture of *Morone* species is to continue at the same rate or to accelerate, and if the increasing demand for fry and fingerlings (i.e., seed stock) by both private interests and governmental agencies is to be met, research efforts must be supported not only by federal and state agencies, but by the private sector as well.

Larval survival and production techniques must be improved to ensure adequate numbers of fingerlings are available for enhancement of natural populations, if and when needed. Wild brood stock should be used for these purposes and should be protected from over-exploitation and other actions by man which threaten their existence. In stock enhancement efforts, strategies should be developed to protect the genetic diversity of the wild populations.

The advent of commercial enterprises (and perhaps, ultimately, for put-and-take recreational fisheries), necessitates development of domestic brood stock (including striped bass, white bass [*M. chrysops*], and perhaps hybrids) to eliminate commercial reliance on wild brood fish populations and from the sometimes capricious regulations of state agencies. Associated with the domestication process, various strains of striped bass and white bass need to be critically evaluated, particularly regarding growth and survival characteristics, disease resistance, and tolerance to differing environmental conditions.

Many research efforts are severely hampered because striped bass and other *Morone* species spawn during a relatively short period in the spring. Studies and accomplishments are limited during that short time frame. Problems resulting from weather, facilities, and other factors can result in aborted research which cannot be repeated until the following year. Because of this, it is our view that determination of requisite physiological and environmental factors (such as hormonal stimulation, temperature, and photoperiod) and development of techniques to effectively spawn *Morone* species to produce larvae on demand would be invaluable in advancing research efforts in the overall culture of the genus. Development of such techniques, coupled with improved intensive culture technology, would be highly advantageous to the aquaculture industry.

Rapid and effective disease diagnosis and control remain a high priority research area. Effects of diseases and parasites can range from minor losses to decimation of cultured fish; yet, treatments that are effective and legally registered are almost totally lacking. Most treatments that have been used successfully in the past, and which were recommended in *Guidelines for Striped Bass Culture* (Bonn et al. 1976), can no longer be used because of potential human health concerns. A major thrust must be made to identify and register therapeutants that are effective,

safe, and economical. Much of this responsibility lies principally within the domain of universities and state and federal agencies.

Methods to increase productivity need to be addressed. If fingerling production is to be increased in pond culture, two requirements must be met — a sufficient supply of acceptable food must be provided; and high quality water must be maintained. Strategies need to be developed to manipulate environmental conditions to favor production of the more desirable zooplankton species and reduce production of the less desirable species. Concomitant with the use of improved techniques designed to maintain acceptable dissolved oxygen and other water quality variables (such as aeration), it may be possible to substantially improve production.

As more agencies acquire "new generation" ponds, complete with plastic liners, it will be necessary to develop new fertilization strategies or to modify existing ones to more effectively utilize the new structures. In essence, a mesocosm approach must be developed because biological, physical, and chemical characteristics all have integral roles in evolution of ecosystems, and each production pond is a small ecosystem.

Progress has been made in intensive culture techniques for larval striped bass based on the original work of Nicholson (1973) and Lewis et al. (1981). However, serious problems remain and, at present, only a few facilities have been successful in producing significant numbers of striped bass fingerlings in intensive culture facilities. Survival is normally less than 10%, compared to means of 30-50% in pond rearing systems, and the intensive rearing systems are expensive to build and operate, complex, and highly labor intensive. If intensive culture is to play a major role in *Morone* culture, we must more accurately define the various physiological and environmental requirements of the larvae.

Careful examination of factors such as water quality, design of rearing units, nutrition, cannibalism, and conditions necessary for swim bladder inflation are needed to improve production levels. A critical stage in development occurs during transition (metamorphosis) from postlarvae to juveniles, concurrent with converting larvae from a live natural food (such as brine shrimp) to an artificial diet, and large numbers often die during this period. Lewis et al. (1981) suggested that high mortality results from inadequate nutrition and failure of some postlarvae to convert to the artificial diet.

Paramount to furthering culture success of striped bass and hybrids is research on nutritional requirements which ultimately leads to development of optimum diets for each life stage of the fish under differing culture conditions (intensive and extensive, tank and pond). Trout and salmon diets are often used successfully for fingerlings through adults, but these may be suboptimal or uneconomical for *Morone* species. These diets can result in large quantities of visceral fat, and feed conversion ratios tend to range from 1.8-2.5 or higher. More optimal diets could result in healthier, more stress-resistant fish, and better food utilization.

Stress and interactions between stress and other factors such as nutrition and disease, continue to be a significant factor in culture, handling, and transport of *Morone*. Research is

needed to better understand the physiological basis of stress and to develop methods to more effectively alleviate it. Examples include studies of the effects of nutritional factors on the magnitude of the stress response, and investigations designed to identify anesthetics, which can be registered, that are more effective in mitigating stress.

Determination of the mechanism of gas bladder inflation in larval striped bass is a high priority research area. Although not conclusively demonstrated, it appears that larvae subjected to intensive culture systems during the first 10-12 days of life may be more likely to have lower percentages of bladder inflation than larvae that are stocked in ponds at 4-5 days of age. Optimal conditions for air bladder inflation of larvae held in intensive systems must be determined and culture facilities and techniques designed accordingly.

Quality of sex products is continually a factor of concern. Low egg and semen quality are problems that occur without explanation in some hatcheries at various times. With present technology, egg quality cannot be predicted until cell division begins and fertilization percentages are determined. As a result, semen that may be available in limited quantities is frequently used on low quality eggs. Similarly, low quality semen may often be used on high quality eggs because of the inability to determine sperm quality prior to fertilization. Experience has shown that motility alone is not a good criterion for assessment of sperm quality. Development of methodology to accurately assess gamete quality prior to fertilization would greatly improve fry production and conserve high quality gametes.

Additionally, various types of aberrations in development of eggs or larvae occur that have gone unexplained. For example, eggs with high fertilization rates sometimes have a fragile, brittle chorion that burst at the slightest pressure. Prolarvae that survive to hatch from these eggs appear normal, but some doubt must remain about the probability of their long-term survival. Other abnormalities, such as detachment of oil globules or developing cells from the yolk and multiple oil droplets (resulting from failure to fully coalesce), are sometimes seen. Because these phenomena appear to be associated with eggs from specific females, it is unlikely that they result from conditions in the hatchery. Whether such conditions are genetic or are the results of disease, pollutants, or other factors is unknown. Research in these areas is needed with the objective of determining the causes and alleviating the conditions causing them.

Hatcheries sometimes have difficulty in obtaining an adequate supply of ripe males, and it is often difficult to obtain males and females of different species at appropriate times for hybridization. Kerby (1983) successfully developed techniques for cryopreservation of striped bass sperm on an experimental basis, but further work to refine the methods on a production scale yielded results that were too inconsistent to be recommended as standard hatchery practice (Kerby and Bodolus 1988). New research initiatives need to be undertaken to develop or refine cryopreservation techniques for *Morone* species so that the available resources can be utilized to the greatest extent.

Research needs to address genetic considerations in situations when fish are produced for commercial and recreational put-and-take fisheries. Conservation genetics of natural popu-

lations has only recently been recognized in fisheries management. Simple steps to maintain genetic integrity of wild stocks must be considered and implemented at the state level.

Classical selection procedures and genetic manipulation techniques such as hybridization, backcrossing and outcrossing, and triploid induction can elicit increased hardiness and other desirable characteristics such as disease resistance, tolerance of various stressors, and tolerance to varying culture conditions. As gene insertion techniques become more feasible, they should also be examined as tools for enhancing characteristics desirable in fish cultured for specific purposes.

Research in these and other areas of concern requires continuity and a long term commitment to funding, facilities, and manpower. If these requirements are met, progress will be rapid and the future for increasingly enhanced culture of *Morone* is bright.

The Future and Direction of Commercial Aquaculture

Recently, substantial progress has been achieved in the development of commercial culture techniques and culture systems for the production of striped bass and its hybrids as food fish (Kerby et al. 1983a,b, 1987a; Woods et al. 1983, 1985a; Kerby 1986; Huish et al. 1987; Hodson et al. 1987; Smith 1988, 1989, 1990; Smith et al. 1989). As a result, a small commercial industry has developed which is expected to expand (Smith 1989). At present, there are commercial food fish pond operations in South Carolina, North Carolina, Virginia, Maryland, Louisiana, Texas, Mississippi, and Pennsylvania. Likewise, there is a commercial operation in California which has demonstrated the feasibility of using geothermal water to grow fish in intensive tank rearing systems. About 600,000 pounds were produced in this system in 1989, and substantial increases are expected in the future (Van Olst and Carlberg 1990). Several other ventures are also attempting large-scale commercial production of striped bass and hybrids in intensive systems. After the basic biological requirements of these fish are determined, including nutrition and disease control, such systems are expected to become increasingly important. However, in the near-term, pond culture systems will probably be the preferred approach because lower initial investment capital and less technical skill is required. Further, there is reduced risk of catastrophic losses, and these systems can be easily integrated with existing agricultural operations. Indeed, pond culture operations are currently being established, or are planned, in most of the southeastern United States where climate permits production of marketable fish in about two years.

In spite of the commercial interests, there are a number of issues which must be resolved for large-scale development to proceed. A basic requirement of any aquaculture industry is a dependable supply of affordable seed stock. This has not yet been accomplished for the striped bass and hybrid bass industry, as brood stock are typically captured from public waters. This dependency causes a number of concerns from private and public perspectives. Private growers are subject to the vagaries of nature, and to some degree, man induced changes (environmental and political). Conversely, the public sector perceives the collection of wild fishes for commercial development purposes as generally unacceptable. This attitude is expected to

be expressed more vocally as recreational fishing pressures increase. However, production of cultured brood stock and semi-domestication of wild brood stock is possible, and private growers are now having some success in producing farm-reared brood stock (Smith and Jenkins 1985, 1987, 1988a,b; Smith 1988; Woods et al. 1990; T. M. Freeze, Keo Fish Farm, Incorporated, personal communication). The problem of brood stock acquisition and production of affordable seed stock is expected to be resolved within the next 5-10 years.

Striped bass and hybrid striped bass are classified as game fish in most states, which results in a number of legal restrictions on their culture and sale. Restrictions are often based on concerns of resource managers and law enforcement officers that wild fishes will be illicitly taken and marketed under the guise of a cultured product. Although this possibility does exist, it is not likely to occur often because culturists must provide uniform, quality products that are aesthetically pleasing. To maintain high quality, cultured fish are usually alive or freshly iced on delivery. Wild-caught fish seldom provide this quality.

Poaching of natural resources has always been a problem that receives public attention. In most cases, poaching is controlled by the vigilance of law enforcement agencies, coupled with laws which reduce the economic attractiveness of such activities.

Recent studies, conducted as part of a cooperative project of the National Marine Fisheries Service and the State of South Carolina, indicate that biochemical techniques can distinguish between wild and cultured fish, and can also identify specific species (Jahncke et al. 1989, 1990). Such techniques are expected to become increasingly important in the protection and conservation of natural resources and should help to guide establishment of laws and regulations conducive to commercial culture and marketing efforts, while protecting public resources.

Striped bass and hybrid striped bass have been marketed primarily to white tablecloth restaurants which are willing to pay premium prices for this aquaculture product. However, with the recent opening of the Maryland markets, the wholesale market for small fish (1-2 pound range) is now available. It is expected that as production increases, and current markets become satiated, the market price will decline or stabilize, so it is imperative that product development and new market testing activities be initiated.

Iced and frozen shelf-life storage studies have been conducted on cultured hybrid striped bass. Skinless fillets had high freshness retention for about 5 days as compared to 10 days for headed and gutted hybrids (Jahncke et al. 1988). When frozen properly, skinless fillets retained their initial flavor characteristics for approximately 4-6 months, whereas the headed and gutted product remained in excellent quality for at least 10 months (Jahncke 1989).

Further, restaurant marketing research demonstrated that these fish exhibited excellent consumer appeal (Smith 1989). Retail marketing tests in Florida revealed these fish would be

the preferred fish purchase by housewives (Drda et al. 1985). Expansion into new markets is likely to occur when dependable supplies of high quality product are available.

As with any new industry, there will be many opportunities to increase efficiency and reduce operational costs through research. Proprietary advantage will be the incentive to conduct private research; however, research is often costly and time consuming, so it is usually sponsored and conducted in academic and government institutions. It is essential that identification of research priorities and directions be determined jointly by public and private sectors to insure that priority issues are addressed. It is imperative, from an industry-development perspective, that industry drive research and not the reverse, and if this is to be the case, then industry must be willing to pay its share.

Commercial culture offers a number of benefits to society and should be accepted by natural resource agencies as a respectable industry. Both have common interests to maintain high water quality standards and healthy wild fish populations. This is especially important to culturists as they currently rely on the natural environment for at least part of their business operations. On a national level, commercial operations have the potential to supply wholesome fishery products to a country that imports about 70% of such products, and can thereby reduce a major trade imbalance. Cultured fish can be, and have been, used to stock private and public waters to enhance recreational fisheries. They can also be used to establish fee fishing operations, which may provide recreational fishing opportunities to areas currently without such opportunities as well as relieve fishing pressure on current public fisheries.

In summary, culture operations focused on the striped bass and its hybrids are expected to expand substantially and to become the basis of an important new commercial industry during the next 25 years. With the establishment of this industry will come increased opportunity for enhancement of public resources and economic gain. In the process, a number of research areas will be addressed which will directly benefit both public and private culture operations.

References

- Albrecht, A. B. 1964. Some observations on factors associated with survival of striped bass eggs and larvae. *California Fish and Game* 50:100-113.
- Allan, J. D. 1976. Life history patterns in zooplankton. *American Naturalist* 110:165-180.
- Allen, K. O. 1974. Notes on the culture of striped bass in tanks and small raceways. *Progressive Fish-Culturist* 36:60-61.
- Allen, K. O., and J. W. Avault, Jr. 1970. Effects of brackish water on ichthyophthiriasis of channel catfish. *Progressive Fish-Culturist* 32:227-230.
- Allen, S. K., Jr., and J. G. Stanley. 1983. Ploidy of hybrid grass carp x bighead carp determined by flow cytometry. *Transactions of the American Fisheries Society* 112:431-435.
- American Fisheries Society. 1983. Committee happenings — Striped Bass Committee. *Southern Division Newsletter*, May 1983.
- Amos, K. H., editor. 1985. Procedures for the detection and identification of certain fish pathogens, 3rd edition. Fish Health Section, American Fisheries Society, Corvallis, Oregon.
- Anderson, J. C. 1966. Production of striped bass fingerlings. *Progressive Fish-Culturist* 28:162-164.
- Anderson, J. R. 1974. Glass v-trap. *Progressive Fish-Culturist* 36:53-55.
- APHA (American Public Health Association), American Water Works Association, and Water Pollution Control Federation. 1975. Standard methods for the examination of waters and waste waters, 14th edition. American Public Health Association, Washington, D.C.
- Atstupenas, E. A., and L. D. Wright. 1987. Interim rearing guidelines for phase II striped bass. U.S. Fish and Wildlife Service, Atlanta, Georgia.
- Avise, J. C., and M. J. Van Den Avyle. 1984. Genetic analysis of reproduction of hybrid white bass x striped bass in the Savannah River. *Transactions of the American Fisheries Society* 113:563-570.

- Axon, J. R., and D. K. Whitehurst. 1985. Striped bass management in lakes with emphasis on management problems. *Transactions of the American Fisheries Society* 114:8-11.
- Bailey, W. M. 1975. An evaluation of striped bass introductions in the southeastern United States. *Proceedings of the Annual Conference Southeastern Association of Game and Fish Commissioners* 28:54-68.
- Barwick, D. H. 1974. The effect of increased sodium chloride on striped bass fry survival in freshwater ponds. *Proceedings of the Annual Conference Southeastern Association of Game and Fish Commissioners* 27:415-419.
- Bayless, J. D. 1968. Striped bass hatching and hybridization experiments. *Proceedings of the Annual Conference Southeastern Association of Game and Fish Commissioners* 21:233-244.
- Bayless, J. D. 1972. Artificial propagation and hybridization of striped bass, *Morone saxatilis* (Walbaum). South Carolina Wildlife and Marine Resources Department, Columbia.
- Beck, M. L., and C. J. Biggers. 1982. Chromosomal investigation of *Ctenopharyngodon idella* x *Aristichthys nobilis* hybrids. *Experientia* 38:319.
- Beers, J. R., G. L. Stewart, and J. D. H. Strickland. 1967. A pumping system for sampling small plankton. *Journal of the Fisheries Research Board of Canada* 24:1811-1818.
- Bennett, R. O., J. N. Kraeuter, L. C. Woods III, M. M. Lipsky, and E. B. May. 1987. Histological evaluation of swim bladder non-inflation in striped bass larvae, *Morone saxatilis*. *Diseases of Aquatic Organisms* 3:91-95.
- Berkeley Pump Company. 1965. Engineering data and conversion factors. Engineering manual. Berkeley Pump Company, 5300 West Park Drive, SW, Atlanta, Georgia.
- Berry, C. R., Jr., W. T. Helm, and J. M. Neuhold. 1983. Safety in fishery field work. Pages 43-60 in L. A. Nielsen and D. L. Johnson, editors. *Fisheries techniques*. American Fisheries Society, Bethesda, Maryland.
- Bishop, R. D. 1968. Evaluation of the striped bass (*Roccus saxatilis*) and white bass (*R. chrysops*) hybrids after two years. *Proceedings of the Annual Conference Southeastern Association of Game and Fish Commissioners* 21:245-254.
- Bishop, R. D. 1975. The use of circular tanks for spawning striped bass (*Morone saxatilis*). *Proceedings of the Annual Conference Southeastern Association of Game and Fish Commissioners* 28:35-44.

- Bonn, E. W., W. M. Bailey, J. D. Bayless, K. E. Erickson, and R. E. Stevens, editors. 1976. Guidelines for striped bass culture. Striped Bass Committee, Southern Division, American Fisheries Society, Bethesda, Maryland.
- Bottrell, H. H., A. Duncan, Z. M. Gliwicz, E. Grygierek, A. Herzig, A. Hillbricht-Ilkowska, H. Kurasawa, P. Larsson, and T. Weglenska. 1976. A review of some problems in zooplankton production studies. *Norwegian Journal of Zoology* 24:419-456.
- Bowker, R. G., D. J. Baumgartner, J. A. Hutcheson, R. H. Ray, and T. L. Wellborn, Jr. 1969. Striped bass *Morone saxatilis* (Walbaum): 1968 report on the development of essential requirements for production. U.S. Fish and Wildlife Service, Atlanta, Georgia.
- Boyd, C. E. 1979. Water quality in warmwater fish ponds. Auburn University, Agricultural Experiment Station, Auburn, Alabama.
- Boyd, C. E. 1982. Water quality management for pond fish culture. Elsevier Scientific Publishing Company, New York.
- Boyd, C. E. 1984. Fluids beat granular in fish pond trials. *Solutions* 28 (February):56-62. (Fluid Fertilizer Industry, Peoria, Illinois).
- Boyd, C. E., and T. Ahmad. 1987. Evaluation of aerators for channel catfish farming. Alabama Agricultural Experiment Station, Bulletin 584, Auburn University, Auburn.
- Braid, M. R., and E. W. Shell. 1981. Incidence of cannibalism among striped bass fry in an intensive culture system. *Progressive Fish-Culturist* 43:210-212.
- Braschler, E. W. 1975. Development of pond culture techniques for striped bass *Morone saxatilis* (Walbaum). Proceedings of the Annual Conference Southeastern Association of Game and Fish Commissioners 28:44-48.
- Brooks, J. L. 1959. Cladocera. Pages 587-656 in H. B. Ward, G. C. Whipple, and W. T. Edmondson, editors. *Fresh-water biology*, 2nd edition. John Wiley and Sons, New York.
- Brown, J. H. 1989. Antibiotics: their use and abuse in aquaculture. *World Aquaculture* 20(2):34-35, 38-39, 42-43.
- Bulak, J. S., and R. C. Heidinger. 1980. Developmental anatomy and inflation of the gas bladder in striped bass, *Morone saxatilis*. U.S. National Marine Fisheries Service, Fishery Bulletin 77:1000-1003.
- Bullock, G. L. 1971. The identification of fish pathogenic bacteria. Book 2B in S. F. Snieszko and H. R. Axelrod, editors. *Diseases of fishes*. T.F.H. Publications, Neptune City, New Jersey.

- Bullock, G. L. 1977. Vibriosis in fish. U.S. Fish and Wildlife Service, Fish Disease Leaflet 77.
- Bullock, G. L. 1978. Pasteurellosis of fishes. U.S. Fish and Wildlife Service, Fish Disease Leaflet 54.
- Busch, C. D. 1980. Water circulation for pond aeration and energy conservation. Proceedings of the World Mariculture Society 11:93-101.
- Busch, C. D., and R. K. Goodman. 1983. Fishpond management without emergency aeration. Transactions of the American Society of Agricultural Engineers 26:290-296.
- Carlberg, J. M., and J. C. Van Olst. 1987. Processing and marketing. Pages 73-82 in R. Hodson, T. Smith, J. McVey, R. Harrell, and N. Davis, editors. Hybrid striped bass culture: status and perspective. UNC Sea Grant Publication UNC-SG-87-03. North Carolina State University, Raleigh.
- Carlberg, J. M., J. C. Van Olst, M. J. Massingill, and T. A. Hovanec. 1984. Intensive culture of striped bass: a review of recent technological developments. Pages 89-127 in J. P. McCraren, editor. The aquaculture of striped bass: a proceedings. Maryland Sea Grant Publication UM-SG-MAP-84-01. University of Maryland, College Park.
- Carmichael, G. J. 1984. Long distance truck transport of intensively reared largemouth bass. Progressive Fish-Culturist 46:111-115.
- Cassani, J. R., and W. E. Caton. 1986. Efficient production of triploid grass carp (*Ctenopharyngodon idella*) utilizing hydrostatic pressure. Aquaculture 55:43-50.
- Cassani, J. R., D. R. Maloney, H. P. Allaire, and J. H. Kerby. 1990. Problems associated with tetraploid induction and survival in grass carp, *Ctenopharyngodon idella*. Aquaculture 88:273-284.
- Chapman, D. C., W. A. Hubert, and U. T. Jackson. 1988. Influence of access to air and of salinity on gas bladder inflation in striped bass. Progressive Fish-Culturist 50:23-27.
- Chapman, R. W. 1989. Spatial and temporal variation of mitochondrial DNA haplotype frequencies in the striped bass (*Morone saxatilis*) 1982 year class. Copeia 1989:344-348.
- Chester Jones, I., D. K. O. Chan, I. W. Henderson, and J. N. Ball. 1969. The adrenocortical steroids, adrenocorticotropin and the corpuscles of Stannius. Pages 321-376 in W. S. Hoar and D. J. Randall, editors. Fish physiology, volume 2. Academic Press, New York.
- Chourrout, D. 1984. Pressure-induced retention of second polar body and suppression of first cleavage in rainbow trout: production of all-triploids, all-tetraploids and heterozygous and homozygous diploid gynogenetics. Aquaculture 36:111-126.

- Chourrout, D., B. Chevassus, F. Krieg, A. Happe, G. Burger, and P. Renard. 1986. Production of second generation triploid and tetraploid rainbow trout by mating tetraploid males and diploid females - potential of tetraploid fish. *Theoretical and Applied Genetics* 72:193-206.
- Colt, J. 1986. An introduction to water quality management in intensive aquaculture. Pages 1-16 in H. Lorz, convener. Section 6. Uses of supplemental oxygen. Northwest Fish Culture Conference, Eugene, Oregon.
- Colt, J., and G. Bouck. 1984. Design of packed columns for degassing. *Aquaculture Engineering* 3:251-273.
- Colt, J., and B. Watten. 1988. Applications of pure oxygen in fish culture. *Aquaculture Engineering* 7:397-441.
- Coutant, C. C. 1985a. Striped bass: environmental risks in fresh and salt water. *Transactions of the American Fisheries Society* 114:1-2.
- Coutant, C. C. 1985b. Striped bass, temperature, and dissolved oxygen: a speculative hypothesis for environmental risk. *Transactions of the American Fisheries Society* 114:31-61.
- Coutant, C. C. 1987. Poor reproductive success of striped bass from a reservoir with reduced summer habitat. *Transactions of the American Fisheries Society* 116:154-160.
- Cox, D. K., and C. C. Coutant. 1981. Growth dynamics of juvenile striped bass as functions of temperature and ration. *Transactions of the American Fisheries Society* 110:226-238.
- Crawford, T., M. Freeze, R. Fourn, S. Henderson, G. O'Bryan, and D. Philipp. 1987. Suspected natural hybridization of striped bass in two Arkansas reservoirs. *Proceedings of the Annual Conference Southeastern Association of Fish and Wildlife Agencies* 38:455-469.
- Curtis, T. A., F. W. Sessions, D. Bury, M. Rezk, and R. A. Dunham. 1988. Induction of polyploidy with hydrostatic pressure in striped bass, white bass, and their hybrids. *Proceedings of the Annual Conference Southeastern Association of Fish and Wildlife Agencies* 41:63-69.
- Daily, J. B., and P. Economon. 1983. Selection of water supplies. Pages 37-48 in F. P. Meyer, J. W. Warren, and T. G. Carey, editors. A guide to integrated fish health management in the Great Lakes basin. Great Lakes Fishery Commission Special Publication 83-2, Ann Arbor, Michigan.

- Davies, W. D. 1970. The effects of temperature, pH and total dissolved solids on the survival of immature striped bass, *Morone saxatilis* (Walbaum). Doctoral dissertation, North Carolina State University, Raleigh.
- Davies, W. D. 1973. Rates of temperature acclimation for hatchery reared striped bass fry and fingerlings. *Progressive Fish-Culturist* 35:214-217.
- Davis, K. B., N. C. Parker, and M. A. Suttle. 1982. Plasma corticosteroids and chlorides in striped bass exposed to tricaine methanesulfonate, quinaldine, etomidate, and salt. *Progressive Fish-Culturist* 44:205-207.
- Davis, K. B., M. A. Suttle, and N. C. Parker. 1984. Biotic and abiotic influences on corticosteroid hormone rhythms in channel catfish. *Transactions of the American Fisheries Society* 113:414-421.
- Davis, K. B., P. Torrance, N. C. Parker, and M. A. Suttle. 1985. Growth, body composition and hepatic tyrosine aminotransferase activity in cortisol-fed channel catfish, *Ictalurus punctatus* Rafinesque. *Journal of Fish Biology* 27:177-184.
- Doroshev, S. I. 1970. Biological features of the eggs, larvae and young of the striped bass (*Roccus saxatilis* (Walbaum)) in connection with the problem of its acclimatization in the USSR. *Journal of Ichthyology* 10:235-248.
- Doroshev, S. I., and J. W. Cornacchia. 1979. Initial swim bladder inflation in the larvae of *Tilapia mossambica* (Peters) and *Morone saxatilis* (Walbaum). *Aquaculture* 16:57-66.
- Drda, T. F., and R. M. Knox. 1982. Bird predation evaluation, Richloam Fish Hatchery. Florida Game and Fresh Water Fish Commission, Tallahassee.
- Drda, T. F., R. M. Knox, and R. B. Stout. 1984. Sunshine bass stocking rate evaluation for advanced fingerling growout. Florida Game and Fresh Water Fish Commission, Tallahassee.
- Drda, T. F., R. M. Knox, and R. B. Stout. 1985. Sunshine bass — preliminary market size (phase III) growout: November 1984 - August 1985. Florida Game and Fresh Water Fish Commission, Tallahassee.
- Dunning, D. J., and Q. E. Ross. 1986. Parameters for assessing Hudson River striped bass stocking. Pages 391-397 in R. H. Stroud, editor. *Fish culture in fisheries management*. Fish Culture Section and Fisheries Management Section, American Fisheries Society, Bethesda, Maryland.

- Dupree, H. K., and J. V. Huner, editors. 1984. Third report to the fish farmers: the status of warmwater fish farming and progress in fish farming research. U.S. Fish and Wildlife Service, Washington, D.C.
- Edmondson, W. T. 1959. Rotifera. Pages 420-494 in H. B. Ward, G. C. Whipple, and W. T. Edmondson, editors. Fresh-water biology, 2nd edition. John Wiley and Sons, New York.
- Eldridge, M. B., J. A. Whipple, D. Eng, M. J. Bowers, and B. M. Jarvis. 1981. Effects of food and rearing factors on laboratory-reared striped bass larvae. Transactions of the American Fisheries Society 110:111-120.
- Emerson, K., R. C. Russo, R. E. Lund, and R. V. Thurston. 1975. Aqueous ammonia equilibrium calculations: effects of pH and temperature. Journal of the Fisheries Research Board of Canada 32:2379-2383.
- Falconer, D. S. 1981. Introduction to quantitative genetics, 2nd edition. Longman, New York.
- Farquhar, B. W., and J. G. Geiger. 1984. Portable zooplankton sampling apparatus for hatchery ponds. Progressive Fish-Culturist 46:209-211.
- Fitzmayer, K. M., J. I. Broach, and R. D. Estes. 1986. Effects of supplemental feeding on growth, production, and feeding habits of striped bass in ponds. Progressive Fish-Culturist 48:18-24.
- Fitzmayer, K. M., J. G. Geiger, and M. J. Van Den Avyle. 1982. Effects of chronic exposure to simazine on the cladoceran, *Daphnia pulex*. Archives of Environmental Contamination and Toxicology 11:603-609.
- Fitzmayer, K. M., J. G. Geiger, and M. J. Van Den Avyle. 1985. Acute toxicity effects of simazine on *Daphnia pulex* and larval striped bass. Proceedings of the Annual Conference Southeastern Association of Fish and Wildlife Agencies 36:146-156.
- Foissner, W., G. L. Hoffman, and A. J. Mitchell. 1985. *Heteropolaria colisarum* Foissner and Scubert, 1977 (Protozoa: Epistylididae) of North American freshwater fishes. Journal of Fish Diseases 8:145-160.
- Fontaine, C. T., and D. B. Revera. 1980. The mass culture of the rotifer, *Brachionus plicatilis*, for use as foodstuff in aquaculture. Proceedings of the World Mariculture Society 11:211-218.
- Forshage, A. A., W. D. Harvey, K. E. Kulzer, and L. T. Fries. 1988. Natural reproduction of white bass x striped bass hybrids in a Texas reservoir. Proceedings of the Annual Conference Southeastern Association of Fish and Wildlife Agencies 40:9-14.

- Frankel, O. H., and Soulé, M. E. 1981. Conservation and evolution. Cambridge University Press, New York.
- Fries, L. T., and W. D. Harvey. 1989. Natural hybridization of white bass with yellow bass in Texas. Transactions of the American Fisheries Society 118:87-89.
- Fritzsche, R. A., and G. D. Johnson. 1980. Early osteological development of white perch and striped bass with emphasis on identification of their larvae. Transactions of the American Fisheries Society 109:387-406.
- Fuss, J. T. 1983. Evaluation of a heat pump for an aquacultural application. Progressive Fish-Culturist 45:121-123.
- Gaines, J. L., Jr., and W. A. Rogers. 1972. Fish mortalities associated with *Goezia* sp. (Nematoda: Ascaroidea) in central Florida. Proceedings of the Annual Conference Southeastern Association of Game and Fish Commissioners 25:496-497.
- Geiger, J. G. 1983a. Zooplankton production and manipulation in striped bass rearing ponds. Aquaculture 35:331-351.
- Geiger, J. G. 1983b. A review of pond zooplankton production and fertilization for the culture of larval and fingerling striped bass. Aquaculture 35:353-369.
- Geiger, J. G., and N. C. Parker. 1985. Survey of striped bass hatchery management in the southeastern United States. Progressive Fish-Culturist 47:1-13.
- Geiger, J. G., C. J. Turner, K. M. Fitzmayer, and W. C. Nichols. 1985. Feeding habits of larval and fingerling striped bass and zooplankton dynamics in fertilized rearing ponds. Progressive Fish-Culturist 47:213-223.
- Goodyear, C. P. 1985. Toxic materials, fishing, and environmental variation: simulated effects on striped bass population trends. Transactions of the American Fisheries Society 114:107-113.
- Goudie, C. 1988. Some triploid grass carp can be induced to spawn. U.S. Fish and Wildlife Service, Research Information Bulletin 88-24, Washington, D.C.
- Graves, K. G., and J. C. Morrow. 1988. Tube sampler for zooplankton. Progressive Fish-Culturist 50:182-183.
- Guest, W. C. 1987. Trihybrid sunfishes: their growth, catchability, and reproductive success compared to parentals and hybrids. Proceedings of the Annual Conference Southeastern Association of Fish and Wildlife Agencies 38:421-435.

- Haney, J. F., and D. T. Hall. 1973. Sugar-coated *Daphnia*: a preservation technique for Cladocera. *Limnology and Oceanography* 18:331-333.
- Harrell, R. M. 1982. Enhancement of striped bass populations in Santee River, South Carolina. Job Completion Report AFS-8. South Carolina Wildlife and Marine Resources Department, Columbia.
- Harrell, R. M. 1983. Life history and population enhancement of striped bass in the Santee River, South Carolina. Job Progress Report DWC-I. South Carolina Wildlife and Marine Resources Department, Columbia.
- Harrell, R. M. 1984a. Review of striped bass brood stock acquisition, spawning methods and fry production. Pages 45-57 in J. P. McCraren, editor. *The aquaculture of striped bass: a proceedings*. Maryland Sea Grant Publication UM-SG-MAP-84-01. University of Maryland, College Park.
- Harrell, R. M. 1984b. Identification of hybrids of the *Morone* complex (Percichthyidae) by means of osteological patterns, meristics, and morphometrics. Doctoral dissertation, University of South Carolina, Columbia.
- Harrell, R. M. 1984c. Tank spawning of first generation striped bass x white bass hybrids. *Progressive Fish-Culturist* 46:75-78.
- Harrell, R. M. 1985. Survival and production of one- and seven-day-old striped bass larvae in hatchery ponds. *Journal of the World Mariculture Society* 16:82-86.
- Harrell, R. M. 1987. Factors affecting and effecting hatchery production and survival of Chesapeake Bay striped bass. Completion Report of the University of Maryland, Horn Point Environmental Laboratories to U.S. Fish and Wildlife Service, Contract 14-16-0009-85-012, Washington, D.C.
- Harrell, R. M. 1988. Catch and release mortality of striped bass caught with artificial lures and baits. *Proceedings of the Annual Conference Southeastern Association of Fish and Wildlife Agencies* 41:70-75.
- Harrell, R. M., and J. Bukowski. 1990. The culture, zooplankton dynamics and predator-prey interactions of Chesapeake Bay striped bass, *Morone saxatilis* (Walbaum), in estuarine ponds. *Aquaculture and Fisheries Management* 21:195-212.
- Harrell, R. M., and J. M. Dean. 1987. Pterygiophore interdigitation patterns and morphometry of larval hybrids of *Morone* species. *Transactions of the American Fisheries Society* 116:719-727.

- Harrell, R. M., and J. M. Dean. 1988. Identification of juvenile hybrids of *Morone* based on meristics and morphometrics. *Transactions of the American Fisheries Society* 117:529-535.
- Harrell, R. M., H. A. Loyacano, Jr., and J. D. Bayless. 1977. Zooplankton availability and feeding selectivity of fingerling striped bass. *Georgia Journal of Science* 35:129-135.
- Harrell, R. M., D. W. Meritt, J. N. Hochheimer, D. W. Webster, and W. D. Miller. 1988. Overwintering success of striped bass and hybrid striped bass held in cages in Maryland. *Progressive Fish-Culturist* 50:120-121.
- Harrell, R. M., and M. A. Moline. 1988. Plasma corticosteroid and chloride dynamics of striped bass as indicators of stress when comparing two capture techniques. *Journal of the World Aquaculture Society* 19:35A. Abstract.
- Hart, L. G., and R. C. Summerfelt. 1975. Surgical procedures for implanting ultrasonic transmitters into flathead catfish (*Pylodictis olivaris*). *Transactions of the American Fisheries Society* 104:56-59.
- Harvey, W. D., and L. T. Fries. 1988. Identification of *Morone* species and congeneric hybrids using isoelectric focusing. *Proceedings of the Annual Conference Southeastern Association of Fish and Wildlife Agencies* 41:251-256.
- Hawke, J. P. 1976. A survey of the diseases of striped bass, *Morone saxatilis* and pompano, *Trachinotus carolinus* cultured in earthen ponds. *Proceedings of the World Mariculture Society* 7:495-509.
- Hawke, J. P., and R. V. Minton. 1985. Fish pasteurellosis in cultured striped bass (*Morone saxatilis*) in coastal Alabama. *American Fisheries Society, Fish Health Section Newsletter* 13(2):7, Bethesda, Maryland.
- Hazel, C. R., W. Thomsen, and S. J. Meith. 1971. Sensitivity of striped bass and stickleback to ammonia in relation to temperature and salinity. *California Fish and Game* 57:138-153.
- Hebert, P. D. N. 1978. The population biology of *Daphnia* (Crustacea, Daphnidae). *Biological Review* 53:387-426.
- Herman, R. L. 1985. Brief reports. *American Fisheries Society, Fish Health Section Newsletter* 13(1):8, Bethesda, Maryland.
- Hewett, S. W., and B. L. Johnson. 1987. A generalized bioenergetics model of fish growth for microcomputers. *University of Wisconsin Sea Grant Technical Report WIS-SG-87-245*.

- Hodson, R., T. Smith, J. McVey, R. Harrell, and N. Davis, editors. 1987. Hybrid striped bass culture: status and perspective. UNC Sea Grant College Publication UNC-SG-87-03. North Carolina State University, Raleigh.
- Hoffman, G. L., and J. A. Hutcheson. 1970. Unusual pathogenicity of a common metacercaria of fish. *Journal of Wildlife Diseases* 6:109.
- Houde, E. D., and R. C. Schekter. 1978. Simulated food patches and survival of larval bay anchovy, *Anchoa mitchilli*, and sea bream, *Archosargus rhomboidalis*. U.S. National Marine Fisheries Service Fishery Bulletin 76:483-487.
- Hubert, W. A. 1983. Passive capture techniques. Pages 95-122 in L. A. Nielsen and D. L. Johnson, editors. *Fisheries techniques*. American Fisheries Society, Bethesda, Maryland.
- Huet, Marcel. 1972. Textbook of fish culture: breeding and cultivation of fishes. Fishing News Books, Surrey, England.
- Hughes, J. S. 1969. Toxicity of some chemicals to striped bass (*Morone saxatilis*). Proceedings of the Annual Conference Southeastern Association of Game and Fish Commissioners 22:230-234.
- Hughes, J. S. 1971. Tolerance of striped bass, *Morone saxatilis* (Walbaum), larvae and fingerlings to nine chemicals used in pond culture. Proceedings of the Annual Conference Southeastern Association of Game and Fish Commissioners 24:431-438.
- Hughes, J. S. 1973. Acute toxicity of thirty chemicals to striped bass, (*Morone saxatilis*). Proceedings of the Annual Conference Western Association of State Game and Fish Commissioners 53:399-413.
- Huish, M. T., J. H. Kerby, and J. M. Hinshaw. 1987. Commercial production and sale of striped bass hybrids in a North Carolina farm pond. *Journal of the World Aquaculture Society* 18:8A-9A. Abstract.
- Humphries, E. T., and K. B. Cumming. 1972. Food habits and feeding selectivity of striped bass fingerlings in culture ponds. Proceedings of the Annual Conference Southeastern Association of Game and Fish Commissioners 25:522-536.
- Humphries, E. T., and K. B. Cumming. 1973. An evaluation of striped bass fingerling culture. *Transactions of the American Fisheries Society* 102:13-20.
- Huner, J. V., and H. K. Dupree. 1984. Pond management. Pages 17-43, in H. K. Dupree and J. V. Huner, editors. *Third report to the fish farmers*. U.S. Fish and Wildlife Service, Washington, D.C.

- Hurlbert, S. H., J. Zedler, and D. Fairbanks. 1972. Ecosystem alteration by mosquitofish (*Gambusia affinis*) predation. *Science* 175:639-641.
- Hutchinson, G. E. 1967. A treatise on limnology. volume 2. Introduction to lake biology and the limnoplankton. John Wiley and Sons, New York.
- Inslee, T. D. 1979. Holding striped bass larvae in cages until swim-up. *Proceedings of the Annual Conference Southeastern Association of Fish and Wildlife Agencies* 31:422-424.
- Jacobs, F., and G. C. Grant. 1978. Guidelines for zooplankton sampling in quantitative baseline and monitoring programs. EPA 600/3-78-026. Corvallis Environmental Research Laboratory, U.S. Environmental Protection Agency, Corvallis, Oregon.
- Jahncke, M. L. 1989. Sensory characteristics of cultured hybrid striped bass during frozen storage. NOAA (National Oceanic and Atmospheric Administration) Technical Memorandum NMFS (National Marine Fisheries Service) SEFC-220.
- Jahncke, M., M. B. Hale, and J. A. Gooch. 1988. Quality changes in hybrid striped bass skinless fillets and in headed and gutted hybrids during iced storage. Pages 309-320 in S. Otwell, editor. *Proceedings: 12th Annual Conference of the Tropical and Subtropical Fisheries Technological Society of the Americas*. Florida Sea Grant College Program, University of Florida, Gainesville.
- Jahncke, M. L., T. I. J. Smith, and G. T. Seaborn. 1989. Use of fatty acid profiles to distinguish cultured from wild fish: a possible law enforcement tool. *Proceedings of the Annual Conference Southeastern Association of Fish and Wildlife Agencies* 42:546-553.
- Jahncke, M. L., T. I. J. Smith, and G. T. Seaborn. 1990. A biochemical method to distinguish wild from cultured fish. Page 226 in S. Otwell, editor. *Fourteenth Annual Conference of the Tropical and Subtropical Fisheries Technological Society of the Americas*. Florida Sea Grant College Program Technical Report SGR-101, Gainesville.
- Jenkins, W. E., T. I. J. Smith, A. D. Stokes, and R. A. Smiley. 1989. Effect of stocking density on production of advanced juvenile hybrid striped bass. *Proceedings of the Annual Conference Southeastern Association of Fish and Wildlife Agencies* 42:56-65.
- Jensen, G. L. 1988. Commercial production of farm-raised catfish. Louisiana Cooperative Extension Service, Louisiana State University, Baton Rouge.
- Jensen, G. L., and J. D. Bankston. 1988. Guide to oxygen management and aeration in commercial fish ponds. Louisiana Cooperative Extension Service, Louisiana State University, Baton Rouge.

- Johnson, G. D. 1984. Percoidei: Development and relationships. Pages 464-498 in H. G. Moser, W. J. Richards, D. M. Cohen, M. P. Fahay, A. W. Kendall, Jr., and S. L. Richardson, editors. Ontogeny and systematics of fishes. American Society of Ichthyologists and Herpetologists, Special Publication 1:464-498.
- Johnson, S. K. 1987. Recognition and control of diseases common to grow-out aquaculture of red drum. Pages 18-54 in G. W. Chamberlain, R. J. Miget, and M. G. Haby, editors. Manual on red drum aquaculture. IV. Biological, engineering, and regulatory aspects. Texas Agricultural Extension Service, and Sea Grant College Program, Texas A&M University, Corpus Christi.
- Johnson, W. W., and M. T. Finley. 1980. Handbook of acute toxicity of chemicals to fish and aquatic invertebrates. U.S. Fish and Wildlife Service, Resource Publication 137. Washington, D.C.
- Joint Subcommittee on Aquaculture of the Federal Coordinating Council on Science, Engineering, and Technology. 1983. Striped bass species plan. Pages 136-145 in National aquaculture development plan, volume 2, Washington, D.C.
- Jones, A. 1972. Studies on egg development and larval rearing of turbot, *Scophthalmus maximus* L., and brill, *Scophthalmus rhombus* L., in the laboratory. Journal of the Marine Biological Association of the United Kingdom 52:965-986.
- Kawai, A., Y. Yoshida, and M. Kinata. 1965. Biochemical studies on the bacteria in aquarium with circulating system. II. Nitrifying activity of the filter sand. Bulletin of the Japanese Society of Scientific Fisheries 31:65-71.
- Kerby, J. H. 1972. Feasibility of artificial propagation and introduction of hybrids of the *Morone* complex into estuarine environments, with a meristic and morphometric description of the hybrids. Doctoral Dissertation, University of Virginia, Charlottesville.
- Kerby, J. H. 1979. Meristic characters of two *Morone* hybrids. Copeia 1979:513-518.
- Kerby, J. H. 1980. Morphometric characters of two *Morone* hybrids. Proceedings of the Annual Conference Southeastern Association of Fish and Wildlife Agencies 33:344-352.
- Kerby, J. H. 1983. Cryogenic preservation of sperm from striped bass. Transactions of the American Fisheries Society 112:86-94.
- Kerby, J. H. 1984. Cryopreservation of striped bass spermatozoa: problems and progress. Pages 205-213 in J. P. McCraren, editor. The aquaculture of striped bass: a proceedings. Maryland Sea Grant Publication UM-SG-MAP-84-01. University of Maryland, College Park.

- Kerby, J. H. 1986. Striped bass and striped bass hybrids. Pages 127-147 in R. R. Stickney, editor. Culture of nonsalmonid freshwater fishes. CRC Press, Boca Raton, Florida.
- Kerby, J. H. 1987. Genetic manipulation of *Morone*. Pages 61-71 in R. Hodson, T. Smith, J. McVey, R. Harrell, and N. Davis, editors. Hybrid striped bass culture: status and perspective. UNC Sea Grant Publication UNC-SG-87-03. North Carolina State University, Raleigh.
- Kerby, J. H. 1988. Induction of triploidy in hybrid striped bass using hydrostatic pressure. Journal of the World Aquaculture Society 19:41A. Abstract.
- Kerby, J. H., J. D. Bayless, and R. M. Harrell. 1985. Growth, survival, and harvest of striped bass produced with cryopreserved spermatozoa. Transactions of the American Fisheries Society 114:761-765.
- Kerby, J. H., and D. A. Bodolus. 1988. Cryogenic preservation of sperm from striped bass. Final Report to U.S. Fish and Wildlife Service, Contract 14-16-0009-79-132, Washington, D.C.
- Kerby, J. H., V. G. Burrell, Jr., and C. E. Richards. 1971. Occurrence and growth of striped bass x white bass hybrids in the Rappahannock River, Virginia. Transactions of the American Fisheries Society 100:787-790.
- Kerby, J. H., J. M. Hinshaw, and M. T. Huish. 1987a. Increased growth and production of striped bass x white bass hybrids in earthen ponds. Journal of the World Aquaculture Society 18:35-43.
- Kerby, J. H., J. M. Hinshaw, and M. T. Huish. 1989. Induction of triploidy in hybrid striped bass using thermal shock and comparative growth between diploid and triploid offspring. Journal of the World Aquaculture Society 20:47A. Abstract.
- Kerby, J. H., M. T. Huish, G. T. Klar, and N. C. Parker. 1987b. Comparative growth and survival of two striped bass hybrids, a backcross, and striped bass in earthen ponds. Journal of the World Aquaculture Society 18:10A. Abstract.
- Kerby, J. H., and E. B. Joseph. 1979. Growth and survival of striped bass and striped bass x white perch hybrids. Proceedings of the Annual Conference Southeastern Association of Fish and Wildlife Agencies 32:715-726.
- Kerby, J. H., L. C. Woods III, and M. T. Huish. 1983a. Culture of the striped bass and its hybrids: a review of methods, advances and problems. Pages 23-54 in R. R. Stickney and S. P. Meyers, editors. Proceedings of the warmwater fish culture workshop. World Mariculture Society Special Publication 3. Louisiana State University, Baton Rouge.

- Kerby, J. H., L. C. Woods III, and M. T. Huish. 1983b. Pond culture of striped bass x white bass hybrids. *Journal of the World Mariculture Society* 14:613-623.
- King, R. C. 1967. *Piping handbook*, 5th edition. McGraw-Hill, New York.
- Klinger, H., H. Delventhal, and V. Hilge. 1983. Water quality and stocking density as stressors of channel catfish (*Ictalurus punctatus* Raf.). *Aquaculture* 30:263-272.
- Kraeuter, J. N., and C. Woods III. 1987. Culture of striped bass and its hybrids: first feeding to six months. Pages 23-32 in R. Hodson, T. Smith, J. McVey, R. Harrell, and N. Davis, editors. *Hybrid striped bass culture: status and perspective*. UNC Sea Grant Publication UNC-SG-87-03. North Carolina State University, Raleigh.
- Krantz, G. E. 1970. Lymphocystis in striped bass, *Roccus saxatilis*, in Chesapeake Bay. *Chesapeake Science* 11:137-139.
- Lal, K., R. Lasker, and A. Kuljis. 1977. Acclimation and rearing of striped bass larvae in sea water. *California Fish and Game* 63:210-218.
- Lamba, V. J., S. V. Goswami, and B. I. Sundararaj. 1983. Circannual and circadian variations in plasma levels of steroids (cortisol, estradiol-17B, estrone, and testosterone) correlated with the annual gonadal cycle in the catfish, *Heteropneustes fossilis* (Bloch). *General and Comparative Endocrinology* 50:205-225.
- Lawler, A. R. 1977. Dinoflagellate (*Amyloodinium*) infestation of pompano. Pages 257-264 in C. J. Sindermann, editor. *Disease diagnosis and control in North American marine aquaculture*. *Developments in Aquaculture and Fisheries Science* 6. Elsevier North-Holland, New York.
- Legan, R. W. 1982. Ultraviolet light takes on CPI role. *Chemical Engineering* 89:95-100.
- Lenz, J. 1972. A new type of plankton pump on the vacuum principle. *Deep-Sea Research* 19:453-459.
- Leon, K. A. 1983. The effect of hatchery water velocity on the feed consumption, growth, food conversion and stamina of brook trout. *Proceedings of the Northwestern Fish Culture Workshop*. Moscow, Idaho.
- Leong, R. 1967. Evaluation of a pump and reeled hose system for studying the vertical distribution of small plankton. U.S. Fish and Wildlife Service, Special Scientific Report-Fisheries 545.

- Lewis, W. M., R. C. Heidinger, and B. L. Tetzlaff. 1981. Tank culture of striped bass production manual. Illinois Striped Bass Project IDC F-26-R. Fisheries Research Laboratory, Southern Illinois University, Carbondale.
- Logan, H. J. 1968. Comparison of growth and survival rates of striped bass and striped bass x white bass hybrids under controlled environments. Proceedings of the Annual Conference Southeastern Association of Game and Fish Commissioners 21:260-263.
- Mansueti, R. 1958. Eggs, larvae, and young of the striped bass, *Roccus saxatilis*. Maryland Department of Research and Education Contribution 112. Chesapeake Biological Laboratory, Solomons.
- Mansueti, R. J. 1962. Effects of civilization on striped bass and other estuarine biota in Chesapeake Bay and tributaries. Proceedings of the Gulf and Caribbean Fisheries Institute 14:110-136.
- Manziara, R. J., and C. C. Starling. 1976. Calcium and magnesium solution of shock and mortality in striped bass. Florida Game and Freshwater Commission, Tallahassee.
- Matthews, W. J. 1985. Summer mortality of striped bass in reservoirs of the United States. Transactions of the American Fisheries Society 114:62-66.
- Matsusato, T. 1975. Bacterial tuberculoidosis of cultured yellowtail. Pages 115-118 in Proceedings of the 3rd U.S. - Japan Meeting on aquaculture at Tokyo, Japan, 15-16 October 1974. Special Publication of Fishery Agency, Japanese Government and Japan Sea Regional Fisheries Research Laboratory, Niigata, Japan.
- Mauldin, A. C., II, J. M. Grizzle, D. E. Young, and H. E. Henderson. 1988. Use of additional calcium in soft-water ponds for improved striped bass survival. Proceedings of the Annual Conference Southeastern Association of Fish and Wildlife Agencies 40:163-168.
- Mazeaud, M. M., F. Mazeaud, and E. M. Donaldson. 1977. Primary and secondary effects of stress in fish: some new data with a general review. Transactions of the American Fisheries Society 106:201-212.
- McCarty, C. E., J. G. Geiger, L. N. Sturmer, B. A. Gregg, and W. P. Rutledge. 1986. Marine finfish culture in Texas: a model for the future. Pages 249-262 in R. H. Stroud, editor. Fish culture in fisheries management. Fish Culture Section and Fisheries Management Section, American Fisheries Society, Bethesda, Maryland.
- McCraren, J. P., and J. L. Millard. 1978. Transportation of warmwater fishes. Pages 43-88 in Manual of fish culture, section G: Fish transportation. U.S. Fish and Wildlife Service, Washington, D.C.

- McCraren, J. P., J. L. Millard, and A. M. Woolven. 1979. Masoten (Dylox) as a control for clam shrimp in hatchery production ponds. *Proceedings of the Annual Conference Southeastern Association of Fish and Wildlife Agencies* 31:329-331.
- McCraren, J. P., and T. R. Phillips. 1979. Effects of masoten (Dylox) on plankton in earthen ponds. *Proceedings of the Annual Conference Southeastern Association of Fish and Wildlife Agencies* 31:441-448.
- Meade, T. L. 1974. The technology of closed system culture of salmonids. University of Rhode Island, Marine Technical Report 30, Kingston.
- Meffe, G. K. 1986. Conservation genetics and the management of endangered fishes. *Fisheries (Bethesda)* 11(1):14-23.
- Mehrle, P. M., T. A. Haines, S. Hamilton, J. L. Ludke, F. L. Mayer, and M. A. Ribick. 1982. Relationship between body contaminants and bone development in east-coast striped bass. *Transactions of the American Fisheries Society* 111:231-241.
- Meyer, F. P., and J. A. Robinson. 1973. Branchiomycosis: a new fungal disease of North American fishes. *Progressive Fish-Culturist* 35:74-77.
- Meyer, F. P., J. W. Warren, and T. G. Carey, editors. 1983. A guide to integrated fish health management in the Great Lakes basin. Great Lakes Fishery Commission Special Publication 83-2, Ann Arbor, Michigan.
- Millikin, M. R. 1982. Effects of dietary protein concentration on growth, feed efficiency, and body composition of age-0 striped bass. *Transactions of the American Fisheries Society* 111:373-378.
- Millikin, M. R. 1983. Interactive effects of dietary protein and lipid on growth and protein utilization of age-0 striped bass. *Transactions of the American Fisheries Society* 112:185-193.
- Minton, R. V. 1980. Striped bass, *Morone saxatilis*, production and stocking experiments in coastal Alabama. Alabama Department of Conservation and Natural Resources, Marine Resources Division, Federal Aid Annual Report AFCS-12-1, Gulf Shores.
- Minton, R. V. 1982. Striped bass, *Morone saxatilis*, production and stocking experiments in coastal Alabama. Alabama Department of Conservation and Natural Resources, Marine Resources Division, Federal Aid Annual Report AFCS-12-2, Gulf Shores.
- Minton, R. V. 1983. Striped bass, *Morone saxatilis*, production and stocking experiments in coastal Alabama. Alabama Department of Conservation and Natural Resources, Marine Resources Division, Federal Aid Completion Report AFCS-12, Gulf Shores.

- Minton, R. V. 1985. Alabama and Mississippi cooperative striped bass restoration program. Federal Aid Annual Report AFCS-23 Segment 2. NOAA (National Oceanic and Atmospheric Administration), NMFS (National Marine Fisheries Service), St. Petersburg, Florida.
- Minton, R. V., J. P. Hawke, S. R. Heath, M. C. Van Hoose, H. G. Lazauski, H. A. Swingle, and W. M. Tatum. 1985. Research and Management of Alabama Coastal Fisheries. Alabama Department of Conservation and Natural Resources, Marine Resources Division, Federal Aid Completion Report 2-391-R, Gulf Shores.
- Mitchell, A. J. 1984. Parasites and diseases of striped bass. Pages 177-204 in J. P. McCraren, editor. The aquaculture of striped bass: a proceedings. Maryland Sea Grant Publication UM-SG-MAP-84-01. University of Maryland, College Park.
- Moring, J. R. 1986. Stocking anadromous species to restore or enhance fisheries. Pages 59-74 in R. H. Stroud, editor. Fish culture in fisheries management. Fish Culture Section and Fisheries Management Section, American Fisheries Society, Bethesda, Maryland.
- Moss, J. L. 1978. Toxicity of selected chemicals to the fairy shrimp, *Streptocephalus seali*, under laboratory and field conditions. *Progressive Fish-Culturist* 40:158-160.
- Murphy, B. R., and W. E. Kelso. 1986. Strategies for evaluating fresh-water stocking programs: past practices and future needs. Pages 303-313 in R. H. Stroud, editor. Fish culture in fisheries management. Fish Culture Section and Fisheries Management Section, American Fisheries Society, Bethesda, Maryland.
- Nagy, A., Z. Monostory, and V. Csanyi. 1983. Rapid development of the clonal state in successive gynogenetic generations of carp (*Cyprinus carpio*). *Copeia* 1983:745-749.
- Neal, W. E. 1969. Landlocked striped bass of John H. Kerr Reservoir. Project Completion Report, Federal Aid in Fish Restoration Project F-5-R. Virginia Department of Game and Inland Fisheries, Richmond.
- Neal, W. E. 1971. Landlocked striped bass of John H. Kerr Reservoir, a ten year summary of research and management activities. Virginia Commission of Game and Inland Fisheries, Project F-5, Richmond.
- Nicholson, L. C. 1973. Culture of striped bass (*Morone saxatilis*) in raceways under controlled conditions. Proceedings of the Annual Conference Western Association of State Game and Fish Commissioners 53:393-394.
- Nicholson, L. 1986. Striped bass fishery management plan (Gulf of Mexico). Gulf State Marine Fisheries Commission, Publication 16. Ocean Springs, Mississippi.

- Nicholson, L. C. 1989. Mississippi and Alabama cooperative striped bass restoration program. Annual Progress Report AFC-30 Segments 1, 2, 3. NOAA (National Oceanic and Atmospheric Administration), NMFS (National Marine Fisheries Service), St. Petersburg, Florida.
- Nicholson, L. C., J. Y. Christmas III, and R. R. Lukens. 1985. A low cost live food feeder. *Progressive Fish-Culturist* 47:245-248.
- Nigrelli, R. F., and H. Vogel. 1963. Spontaneous tuberculosis in fishes and in other cold-blooded vertebrates with special reference to *Mycobacterium fortuitum* Cruz from fish and human lesions. *Zoologica (New York)* 48:131-144.
- Nikinmaa, M., A. Soivio, T. Nakari, and S. Lindgren. 1983. Hauling stress in brown trout (*Salmo trutta*): physiological responses to transport in fresh water or salt water, and recovery in natural brackish water. *Aquaculture* 34:93-99.
- O'Connell, C. P., and R. J. H. Leong. 1963. A towed pump and shipboard filtering system for sampling small zooplankters. U.S. Fish and Wildlife Service, Special Scientific Report-Fisheries 452.
- Olney, J. E., G. C. Grant, F. E. Schultz, C. L. Cooper, and J. Hageman. 1983. Pterygiophore-interdigitation patterns in larvae of four *Morone* species. *Transactions of the American Fisheries Society* 112:525-531.
- Ott, A. G. 1975. Cryopreservation of Pacific salmon and steelhead trout sperm. Doctoral dissertation. Oregon State University, Corvallis.
- Owsley, D. E. 1981. Nitrogen gas removal using packed columns. Pages 71-82 in L. J. Allen and E. C. Kinney, editors. *Proceedings of the Bio-engineering symposium for fish culture*. American Fisheries Society, Fish Culture Section, Bethesda, Maryland.
- Paller, M. H., and W. M. Lewis. 1987. Effects of diet on growth depensation and cannibalism among intensively cultured larval striped bass. *Progressive Fish-Culturist* 49:270-275.
- Paller, M. H., and W. M. Lewis. 1988. Use of ozone and fluidized-bed biofilters for increased ammonia removal and fish loading rates. *Progressive Fish-Culturist* 50:141-147.
- Paperna, I., and D. E. Zwerner. 1976. Parasites and diseases of striped bass, *Morone saxatilis* (Walbaum), from the lower Chesapeake Bay. *Journal of Fish Biology* 9:267-281.
- Parker, N. C. 1979. Channel catfish production in continuously aerated ponds. Pages 39-52 in *Proceedings of the fish farming conference annual convention, Catfish Farmers of Texas*. Texas A&M University, College Station.

- Parker, N. C. 1980. Striped bass culture in continuously aerated ponds. *Proceedings of the Annual Conference Southeastern Association of Fish and Wildlife Agencies* 33:353-360.
- Parker, N. C. 1983. Air-lift pumps and other aeration techniques. Pages 24-27 in C. S. Tucker, editor. *Water quality in channel catfish ponds. Southern Cooperative Series Bulletin 290. Mississippi Agricultural and Forestry Experiment Station, Mississippi State University, Mississippi State.*
- Parker, N. C. 1984. Culture requirements for striped bass. Pages 29-44 in J. P. McCraren, editor. *The aquaculture of striped bass: a proceedings. Maryland Sea Grant Publication UM-SG-MAP-84-01. University of Maryland, College Park.*
- Parker, N. C., and K. B. Davis. 1981. Requirements of warmwater fish. Pages 21-28 in L. J. Allen and E. C. Kinney, editors. *Proceedings of the Bio-engineering symposium for fish culture. American Fisheries Society, Fish Culture Section, Bethesda, Maryland.*
- Parker, N. C., and J. G. Geiger. 1984. Production methods for striped bass. Pages 106-118 in H. K. Dupree and J. V. Huner, editors. *Third report to the fish farmers: the status of warmwater fish farming and progress in fish farming research. U.S. Fish and Wildlife Service, Washington, D.C.*
- Parker, N. C., and M. A. Suttle. 1987. Design of airlift pumps for water circulation and aeration in aquaculture. *Aquaculture Engineering* 6:97-110.
- Parker, N. C., M. A. Suttle, and K. Fitzmayer. 1984. Total gas pressure and oxygen and nitrogen saturation in warmwater ponds aerated with airlift pumps. *Aquacultural Engineering* 3:91-102.
- Parmley, D. C., and J. G. Geiger. 1985. Succession patterns of zooplankton in fertilized culture ponds without fish. *Progressive Fish-Culturist* 47:183-186.
- Parsons, J. E., R. A. Busch, G. H. Thorgaard, and P. D. Scheerer. 1986. Increased resistance of triploid rainbow trout x coho salmon hybrids to infectious hematopoietic necrosis virus. *Aquaculture* 57:337-343.
- Passino, D. R. M. 1984. Biochemical indicators of stress in fishes: an overview. *Advances in Environmental Science and Technology* 16:37-50.
- Pennak, R. W. 1978. *Fresh-water invertebrates of the United States*, 2nd edition. John Wiley and Sons, New York.
- Pickering, A. D., editor. 1981. *Stress and fish*. Academic Press, London.

- Pickering, A. D. 1984. Cortisol-induced lymphocytopenia in brown trout, *Salmo trutta* L. *General and Comparative Endocrinology* 53:252-259.
- Pickering, A. D., and T. G. Pottinger. 1983. Seasonal and diel changes in plasma cortisol levels of the brown trout, *Salmo trutta* L. *General and Comparative Endocrinology* 49:232-239.
- Piper, R. G., I. B. McElwain, L. E. Orme, J. P. McCraren, L. G. Fowler, and J. R. Leonard. 1982. Fish hatchery management. U.S. Fish and Wildlife Service, Washington, D.C.
- Post, G. W. 1987. Textbook of fish health, 2nd Edition. T.F.H. Publications, Neptune City, New Jersey.
- Powell, M. R. 1973a. Striped bass, *Morone saxatilis*, production to establish commercial stocks in Alabama estuaries. Alabama Department of Conservation and Natural Resources, Marine Resources Division, Federal Aid Completion Report AFCS-3-3, Gulf Shores.
- Powell, M. R. 1973b. Cage and raceway culture of striped bass in brackish water in Alabama. *Proceedings of the Annual Conference Southeastern Association of Game and Fish Commissioners* 26:345-356.
- Prepas, E. 1978. Sugar-frosted *Daphnia*: an improved fixation technique for Cladocera. *Limnology and Oceanography* 23:557-559.
- Price, K. S., D. A. Flemer, J. L. Taft, G. B. Mackiernan, W. Nehlsen, R. B. Biggs, N. H. Burger, and D. A. Blaylock. 1985. Nutrient enrichment of Chesapeake Bay and its impact on the habitat of striped bass: a speculative hypothesis. *Transactions of the American Fisheries Society* 114:97-106.
- Randall, D. J., and W. S. Hoar. 1971. Special techniques. Pages 511-528 in W. S. Hoar and D. J. Randall, editors. *Fish physiology*, volume 6. Academic Press, New York.
- Raney, E. C., E. F. Tresselt, E. H. Hollis, V. D. Vladykov, and D. H. Wallace, editors. 1952. The striped bass (*Roccus saxatilis*). *Bulletin of the Bingham Oceanographic Collection, Yale University* 14.
- Ray, R. H., and L. J. Wirtanen. 1970. Striped bass *Morone saxatilis* (Walbaum): 1969 report on the development of essential requirements for production. U.S. Fish and Wildlife Service, Atlanta, Georgia.
- Reardon, I. S., and R. M. Harrell. 1990. Acute toxicity of formalin and copper sulfate to striped bass fingerlings held in varying salinities. *Aquaculture* 87:255-270.

- Rees, R. A., and S. F. Cook. 1985a. Effects of sunlight intensity on survival of striped bass x white bass fry. *Proceedings of the Annual Conference Southeastern Association of Fish and Wildlife Agencies* 36:83-94.
- Rees, R. A., and S. F. Cook. 1985b. Evaluation of optimum stocking rate of striped bass x white bass fry in hatchery rearing ponds. *Proceedings of the Annual Conference Southeastern Association of Fish and Wildlife Agencies* 37:257-266.
- Reeves, W. C., and F. R. Harders. 1985. Liquid fertilization of public fishing lakes in Alabama. *Proceedings of the Annual Conference Southeastern Association of Fish and Wildlife Agencies* 37:371-375.
- Regan, D. M., T. L. Wellborn, Jr., and R. G. Bowker. 1968. Striped bass, *Morone saxatilis* (Walbaum): 1967 report on the development of essential requirements for production. U.S. Fish and Wildlife Service, Atlanta, Georgia.
- Rey, J. R., R. A. Crossman, T. R. Kain, F. E. Vose., and M. S. Peterson. 1987. Sampling zooplankton in shallow marsh and estuarine habitats: gear description and field tests. *Estuaries* 10:61-67.
- Reynolds, J. B. 1983. Electrofishing. Pages 147-163 in L. A. Nielsen and D. L. Johnson, editors. *Fisheries techniques*. American Fisheries Society, Bethesda, Maryland.
- Robins, C. R., R. M. Bailey, C. E. Bond, J. R. Brooker, E. A. Lachner, R. N. Lea, and W.B. Scott. 1991. *Common and scientific names of fishes from the United States and Canada*, 5th edition. American Fisheries Society Special Publication 20, Bethesda, Maryland.
- Rogers, B. A., and D. T. Westin. 1981. Laboratory studies on effects of temperature and delayed initial feeding on development of striped bass larvae. *Transactions of the American Fisheries Society* 110:100-110.
- Rogers, G. L., and A. W. Fast. 1988. Potential benefits of low energy water circulation in Hawaiian prawn ponds. *Aquaculture Engineering* 7:155-165.
- Rosenthal, H., and G. Krüner. 1985. Treatment efficiency of an improved ozonation unit applied to fish culture situations. *Ozone: Science and Engineering* 7:179-190.
- Rottmann, R. W., J. V. Shireman, C. C. Starling, and W. H. Revels. 1988. Eliminating adhesiveness of white bass eggs for the hatchery production of hybrid striped bass. *Progressive Fish-Culturist* 50:55-57.
- Ruttner-Kolisko, A. 1974. *Plankton rotifers: biology and taxonomy*. E. Schweizerbartsche Verlagsbuchhandlung, Stuttgart, Germany.

- Saeki, A. 1958. Studies on fish culture in the aquarium of closed-circulating system. Its fundamental theory and standard plan. *Bulletin of the Japanese Society of Scientific Fisheries* 23:684-695.
- Sager, D. R., L. C. Woods III, and J. N. Krauter. 1986. Survival of *Morone saxatilis* in low pH oligohaline waters. *Journal of the Washington Academy of Science* 76:237-243.
- Sakanari, J. A., C. A. Reilly, and M. Moser. 1983. Tubercular lesions in Pacific coast populations of striped bass. *Transactions of the American Fisheries Society* 112:565-566.
- Scheerer, P. D., and G. H. Thorgaard. 1983. Increased survival in salmonid hybrids by induced triploidy. *Canadian Journal of Fisheries and Aquatic Sciences* 40:2040-2044.
- Schnick, R. A. 1988. The impetus to register new therapeutants for aquaculture. *Progressive Fish-Culturist* 50:190-196.
- Schnick, R. A., F. P. Meyer, and D. F. Walsh. 1986. Status of fishery chemicals in 1985. *Progressive Fish-Culturist* 48:1-17.
- Schroeder, G. L. 1978. Autotrophic and heterotrophic production of microorganisms in intensely-manured fish ponds, and related fish yields. *Aquaculture* 14:303-325.
- Schroeder, G. L. 1987. Carbon and nitrogen budgets in manured fish ponds on Israel's coastal plain. *Aquaculture* 62:259-279.
- Scruggs, G. D., Jr., and J. C. Fuller, Jr. 1954. Indications of a freshwater population of striped bass, *Roccus saxatilis* (Walbaum), in Santee-Cooper Reservoirs. *Proceedings of the Southeastern Association of Game and Fish Commissioners* 8:64-69.
- Selye, H. 1976. *Stress in health and disease*. Butterworths, Boston, Massachusetts.
- Setzler, E. M., W. R. Boynton, K. V. Wood, H. H. Zion, L. Lubbers, N. K. Mountford, P. Frere, L. Tucker, and J. A. Mihursky. 1980. Synopsis of biological data on striped bass, *Morone saxatilis* (Walbaum). NOAA (National Oceanic and Atmospheric Administration) Technical Report NMFS (National Marine Fisheries Service) Circular 433. (Also: FAO (Food and Agriculture Organization of the United Nations) Fisheries Synopsis 121).
- Shannon, E. H. 1970. Effect of temperature changes upon developing striped bass eggs and fry. *Proceedings of the Annual Conference Southeastern Association of Game and Fish Commissioners* 23:265-274.
- Shannon, E. H., and W. B. Smith. 1968. Preliminary observations on the effect of temperature on striped bass eggs and sac fry. *Proceedings of the Annual Conference Southeastern Association of Game and Fish Commissioners* 21:257-260.

- Siddall, S. E. 1974. Studies of closed marine culture systems. *Progressive Fish-Culturist* 36:8-15.
- Siefert, R. E. 1972. First food of larval yellow perch, white sucker, bluegill, emerald shiner, and rainbow smelt. *Transactions of the American Fisheries Society* 101:219-225.
- Siegel, G. R., W. C. Irwin, A. R. Betbeze, and D. W. Linkins. 1985. Operational experience at TVA's 4,000 m² (1-acre) nonconvecting salt-gradient solar pond. Pages 249-254 in R. B. Bannerot, editor. *Solar engineering - 1985. Proceedings of the joint ASME (American Society of Mechanical Engineers) - ASES (American Solar Energy Society) solar energy conference (SED Seventh Annual Conference)*. The American Society of Mechanical Engineers, New York.
- Smith, B. W., and W. C. Reeves. 1986. Stocking warm-water species to restore or enhance fisheries. Pages 17-29 in R. H. Stroud, editor. *Fish culture in fisheries management*. Fish Culture Section and Fisheries Management Section, American Fisheries Society, Bethesda, Maryland.
- Smith, T. I. J. 1987. Hatchery. Pages 17-22 in R. Hodson, T. Smith, J. McVey, R. Harrell, and N. Davis, editors. *Hybrid striped bass culture: status and perspective*. UNC Sea Grant Publication UNC-SG-87-03. North Carolina State University, Raleigh.
- Smith, T. I. J. 1988. Aquaculture of striped bass and its hybrids in North America. *Aquaculture Magazine* 14(1):40-49.
- Smith, T. I. J. 1989. The culture potential of striped bass and its hybrids. *World Aquaculture* 20(1):32-38.
- Smith, T. I. J. 1990. Aquaculture of striped bass (*Morone saxatilis*) and its hybrids in North America. Pages 53-61 in R. S. Svrjcek, editor. *Genetics and Aquaculture: Proceedings of the 16th Joint Meeting of U.S.-Japan Meeting on Aquaculture*. NOAA (National Oceanic and Atmospheric Administration) Technical Report NMFS (National Marine Fisheries Service) 92.
- Smith, T. I. J., and W. E. Jenkins. 1984. Controlled spawning of F₁ hybrid striped bass (*Morone saxatilis* x *Morone chrysops*) and rearing of F₂ progeny. *Journal of the World Mariculture Society* 15:147-161.
- Smith, T. I. J., and W. E. Jenkins. 1985. Status of aquaculture of striped bass (*Morone saxatilis*) and its white bass (*Morone chrysops*) hybrids, and current research in South Carolina. Pages 553-582 in *Proceedings of the 2nd International Conference on Warm Water Aquaculture Fin Fish*. Brigham Young University, Laie, Hawaii.

- Smith, T. I. J., and W. E. Jenkins. 1987. Aquaculture research with striped bass (*Morone saxatilis*) and its hybrids in South Carolina. Proceedings of the Annual Conference Southeastern Association of Fish and Wildlife Agencies 39:217-227.
- Smith, T. I. J., and W. E. Jenkins. 1988a. Culture and controlled spawning of striped bass (*Morone saxatilis*) to produce striped bass and striped bass x white bass (*Morone chrysops*) hybrids. Proceedings of the Annual Conference Southeastern Association of Fish and Wildlife Agencies 40:152-162.
- Smith, T. I. J., and W. E. Jenkins. 1988b. Broodstock development and spawning of striped bass, *Morone saxatilis*, and white bass, *M. chrysops*. Journal of the World Aquaculture Society 19:65A. Abstract.
- Smith, T. I. J., W. E. Jenkins, and R. W. Haggerty. 1988. Growth and survival of juvenile striped bass (*Morone saxatilis*) x white bass (*M. chrysops*) hybrids reared at different salinities. Proceedings of the Annual Conference Southeastern Association of Fish and Wildlife Agencies 40:143-151.
- Smith, T. I. J., W. E. Jenkins, and J. F. Snelvel. 1985. Production characteristics of striped bass (*Morone saxatilis*) and F₁, F₂ hybrids (*M. saxatilis* and *M. chrysops*) reared in intensive tank systems. Journal of the World Mariculture Society 16:57-70.
- Smith, T. I. J., W. E. Jenkins, A. D. Stokes, and R. A. Smiley. 1989. Semi-intensive pond production of market-size striped bass (*Morone saxatilis*) x white bass (*M. chrysops*) hybrids. World Aquaculture 20(1):81-83.
- Smith, W. B., W. R. Bonner, and B. L. Tatum. 1967. Premature egg procurement from striped bass. Proceedings of the Annual Conference Southeastern Association of Game and Fish Commissioners 20:324-330.
- Snieszko, S. F. 1978. Mycobacteriosis (tuberculosis) of fishes. U.S. Fish and Wildlife Service, Fish Disease Leaflet 55.
- Snieszko, S. F., G. L. Bullock, E. Hollis, and J. G. Boone. 1964. *Pasteurella* sp. from an epizootic of white perch (*Roccus americanus*) in Chesapeake Bay tidewater areas. Journal of Bacteriology 88:1814-1815.
- Snow, J. R. 1979. A technique for controlling weeds in striped bass rearing ponds. Proceedings of the Annual Conference Southeastern Association of Fish and Wildlife Agencies 31:322-328.
- Snow, J. R., T. A. Al-Ahmad, and J. E. Parsons. 1982. Rotifers as a production diet for striped bass fingerlings. Proceedings of the Annual Conference Southeastern Association of Fish and Wildlife Agencies 34:280-291.

- Snow, J. R., and R. O. Jones. 1961. Changes in warm-water ponds after hydrated-lime applications. *Progressive Fish-Culturist* 23:51-60.
- Sorgeloos, P., E. Bossuyt, E. Lavina, M. Baeza-Mesa, and G. Persoone. 1977. Decapsulation of *Artemia* cysts: A simple technique for the improvement of the use of brine shrimp in aquaculture. *Aquaculture* 12:311-315.
- Speece, R. E. 1969. U-tube oxygenation for economical saturation for fish hatchery water. *Transactions of the American Fisheries Society* 98:789-795.
- Spotte, S. 1979. *Fish and invertebrate culture; water management in closed systems*, 2nd edition. John Wiley & Sons, New York.
- Stanley, J. G. 1976. Production of hybrid, androgenetic, and gynogenetic grass carp and carp. *Transactions of the American Fisheries Society* 105:10-16.
- Starling, C. C. 1983. Fish hatcheries review and annual progress report for 1983-84. Florida Game and Fresh Water Fish Commission, Tallahassee.
- Starling, C. C. 1985. Striped bass x white bass *Morone spp.* hybrids (sunshine bass) production at Florida state fish hatcheries. Pages 65-112 in *Fish hatcheries review and annual report for 1984-1985*. Florida Game and Fresh Water Fish Commission, Tallahassee.
- Starling, C. C. 1987. Fish culture research and development. Pages 27-41 in *Fish hatcheries annual progress report for 1986-1987*. Florida Game and Fresh Water Fish Commission, Tallahassee, Florida.
- Stevens, R. E. 1958. The striped bass of the Santee-Cooper Reservoir. *Proceedings of the Annual Conference Southeastern Association of Game and Fish Commissioners* 11:253-264.
- Stevens, R. E. 1966. Hormone-induced spawning of striped bass for reservoir stocking. *Progressive Fish-Culturist* 28:19-28.
- Stevens, R. E. 1967. A final report on the use of hormones to ovulate striped bass, *Roccus saxatilis* (Walbaum). *Proceedings of the Annual Conference Southeastern Association of Game and Fish Commissioners* 18:525-538.
- Stevens, R. E. 1984. Historical overview of striped bass culture and management. Pages 1-15 in J. P. McCraren, editor. *The aquaculture of striped bass: a proceedings*. Maryland Sea Grant Publication UM-SG-MAP-84-01. University of Maryland, College Park.

- Stevens, R. E., O. D. May, Jr., and H. J. Logan. 1965. An interim report on the use of hormones to ovulate striped bass (*Roccus saxatilis*). Proceedings of the Annual Conference Southeastern Association of Game and Fish Commissioners 17:226-237.
- Stickney, R. R., editor. 1986. Culture of nonsalmonid freshwater fishes. CRC Press, Boca Raton, Florida.
- Stout, R. B., and T. F. Drda. 1986. Comparison of reciprocal and original cross sunshine bass for phase III growout. Florida Game and Fresh Water Fish Commission, Tallahassee.
- Strange, R. J. 1980. Acclimation temperature influences cortisol and glucose concentrations in stressed channel catfish. Transactions of the American Fisheries Society 109:298-303.
- Streisinger, G., C. Walker, N. Dower, D. Knauber and F. Singer. 1981. Production of clones of homozygous diploid zebra fish (*Brachydanio rerio*). Nature 291:293-296.
- Surber, E. W. 1958. Results of striped bass (*Roccus saxatilis*) introductions into freshwater impoundments. Proceedings of the Annual Conference Southeastern Association of Game and Fish Commissioners 11:273-276.
- Swartz, D. 1984. Marketing striped bass. Pages 233-254 in J. P. McCraren, editor. The aquaculture of striped bass: a proceedings. Maryland Sea Grant Publication UM-SG-MAP-84-01. University of Maryland, College Park.
- Srna, R. F., and A. Baggaley. 1975. Kinetic response of perturbed marine nitrification systems. Journal of the Water Pollution Control Federation 47:472-486.
- Tatum, B. L., J. D. Bayless, E. G. McCoy, and W. B. Smith. 1966. Preliminary experiments in the artificial propagation of striped bass, *Roccus saxatilis*. Proceedings of the Annual Conference Southeastern Association of Game and Fish Commissioners 19:374-389.
- Tave, D. 1986. Genetics for fish hatchery managers. AVI Publishing Company, Westport, Connecticut.
- Thompson, B. Z., R. J. Wattendorf, R. S. Hestand, and J. L. Underwood. 1987. Triploid grass carp production. Progressive Fish-Culturist 49:213-217.
- Todd, T. N. 1986. Occurrence of white bass-white perch hybrids in Lake Erie. Copeia 1986:196-199.
- Tomasso, J. R., K. B. Davis, and N. C. Parker. 1980. Plasma corticosteroid and electrolyte dynamics of hybrid striped bass (white bass x striped bass) during netting and hauling. Proceedings of the World Mariculture Society 11:303-310.

- Tomasso, J. R., K. B. Davis, and N. C. Parker. 1981. Plasma corticosteroid dynamics in channel catfish, *Ictalurus punctatus* (Rafinesque), during and after oxygen depletion. *Journal of Fish Biology* 18:519-526.
- Tuncer, H., R. M. Harrell, and E. D. Houde. 1990. Comparative energetics of striped bass (*Morone saxatilis*) and hybrid (*M. saxatilis* x *M. chrysops*) juveniles. *Aquaculture* 86:387-400.
- Turner, C. J. 1984. Striped bass culture at Marion Fish Hatchery. Pages 59-85 in J. P. McCraren, editor. *The aquaculture of striped bass: a proceedings*. Maryland Sea Grant Publication UM-SG-MAP-84-01. University of Maryland, College Park.
- U.S. Department of Agriculture. 1973. Restoring surface-mined land. Miscellaneous Publication 1082. U.S. Government Printing Office, Washington, D.C.
- U.S. Department of the Interior, Fish and Wildlife Service, and U.S. Department of Commerce, Bureau of the Census. 1982. 1980 national survey of fishing, hunting and wildlife-associated recreation. U.S. Government Printing Office, Washington, D.C.
- U.S. Environmental Protection Agency. 1976. Quality criteria for water. U.S. Environmental Protection Agency, Washington, D.C.
- Valenti, R. J., J. Aldred, and J. Liebell. 1976. Experimental marine cage culture of striped bass in northern waters. *Proceedings of the World Mariculture Society* 7:99-108.
- Van Olst, J. C., and J. M. Carlberg. 1990. Commercial culture of hybrid striped bass: status and potential. *Aquaculture Magazine* 16(1):49-59.
- Van Olst, J. C., J. M. Carlberg, M. J. Massingill, T. A. Hovanec, M. D. Cochran, and S. I. Doroshev. 1980. Methods for intensive culture of striped bass larvae at Central Valley's hatchery. Progress Report. California Fish and Game, University of California at Davis, and Aquaculture Systems International, Elk Grove, California.
- von Bayer, H. 1910. A method of measuring fish eggs. *U. S. Bureau of Fisheries Bulletin* 28(1908, Pt.2):1011-1014.
- Visscher, L., and W. Godby, compilers. 1987. Oxygen supplementation, a new technology in fish culture. U.S. Fish and Wildlife Service Information Bulletin 1, Denver, Colorado.
- Waldman, J. R. 1986. Diagnostic value of *Morone* dentition. *Transactions of the American Fisheries Society* 115:900-907.
- Ware, F. J. 1975. Progress with *Morone* hybrids in fresh water. *Proceedings of the Annual Conference Southeastern Association of Game and Fish Commissioners* 28:48-54.

- Ware, F. J., W. Fish, and K. Jones. 1976. Investigations of striped bass and *Morone* hybrids. Study I: Development and evaluation of striped bass and *Morone* hybrid fisheries for inland waters. Annual report F-32-2 for 1975-76. Florida Game and Fresh Water Fish Commission, Tallahassee.
- Watten, B. J., and L. T. Beck. 1985. Modeling gas transfer in a U-tube oxygen absorption system: effects of off-gas recycling. *Aquacultural Engineering* 4:271-297.
- Wattendorf, R. J. 1986. Rapid identification of triploid grass carp with a coulter counter and channelyzer. *Progressive Fish-Culturist* 48:125-132.
- Wattendorf, R. J., and P. L. Shafland. 1982. Observations on salinity tolerance of striped bass x white bass hybrids in aquaria. *Progressive Fish-Culturist* 44:148-149.
- Wawronowicz, L. J., and W. M. Lewis. 1979. Evaluation of the striped bass as a pond-reared food fish. *Progressive Fish-Culturist* 41:138-140.
- Weber, C. I., editor. 1973. Biological field and laboratory methods for measuring the quality of surface waters and effluents. EPA 670/4-73-001. U.S. Environmental Protection Agency, Cincinnati, Ohio.
- Wedemeyer, G. 1970. The role of stress in the disease resistance of fishes. Pages 30-35 in S. F. Snieszko, editor. A symposium on diseases of fishes and shellfishes. American Fisheries Society, Washington, D.C.
- Weithman, A. S. 1986. Economic benefits and costs associated with stocking fish. Pages 357-363 in R. H. Stroud, editor. Fish culture in fisheries management. Fish Culture Section and Fisheries Management Section, American Fisheries Society, Bethesda, Maryland.
- Wellborn, T. L., Jr. 1969. The toxicity of nine therapeutic and herbicidal compounds to striped bass. *Progressive Fish-Culturist* 31:27-32.
- Wellborn, T. L., Jr. 1971. Toxicity of some compounds to striped bass fingerlings. *Progressive Fish-Culturist* 33:32-36.
- Westers, H. 1976. Some principles of salmonid hatchery design. Michigan Department of Natural Resources Technical Report 76-1.
- Westers, H. 1983. Considerations in hatchery design for the prevention of diseases. Pages 29-35 in F. P. Meyer, J. W. Warren, and T. G. Carey, editors. A guide to integrated fish health management in the Great Lakes basin. Great Lakes Fishery Commission Special Publication 83-2, Ann Arbor, Michigan.

- Westers, H., and K. M. Pratt. 1977. Rational design of hatcheries for intensive salmonid culture, based on metabolic characteristics. *Progressive Fish-Culturist* 39:157-165.
- Wetzel, R. G. 1975. *Limnology*. W. B. Saunders, Philadelphia.
- Whitehurst, D. K., and C. N. Carwile. 1982. Kerr Reservoir striped bass study. Project Completion Report, Federal Aid in Fish Restoration, Project F-34-R. Virginia Commission of Game and Inland Fisheries, Richmond.
- Williams, H. M. 1971. Preliminary studies of certain aspects of the life history of the hybrid (striped bass x white bass) in two South Carolina reservoirs. *Proceedings of the Annual Conference Southeastern Association of Game and Fish Commissioners* 24:424-431.
- Williams, H. M. 1976. Characteristics for distinguishing white bass, striped bass and their hybrid (striped bass x white bass). *Proceedings of the Annual Conference Southeastern Association of Game and Fish Commissioners* 29:168-172.
- Williams, J. E., P. A. Sandifer, and J. M. Lindbergh. 1981. Net-pen culture of striped bass x white bass hybrids in estuarine waters of South Carolina: a pilot study. *Journal of the World Mariculture Society* 12(2):98-110.
- Wilson, M. S., and H. C. Yeatman. 1959. Free-living Copepoda. Pages 735-861 in H. B. Ward, G. C. Whipple, and W. T. Edmondson, editors. *Fresh-water biology*, 2nd edition. John Wiley and Sons, New York.
- Wirtanen, L. J., and R. H. Ray. 1971. Striped bass *Morone saxatilis* (Walbaum): 1970 report on the development of essential requirements for production. U.S. Fish and Wildlife Service, Atlanta, Georgia.
- Woiwode, J. G. 1989. The effects of temperature, photoperiod and ration size on the growth and thermal resistance of the hybrid striped bass x white bass. Doctoral dissertation. University of Minnesota, St. Paul.
- Woiwode, J. G., and I. R. Adelman. 1984. Growth, food conversion efficiency and survival of hybrid white bass x striped bass as a function of temperature. Pages 143-150 in J. P. McCraren, editor. *The aquaculture of striped bass: a proceedings*. Maryland Sea Grant Publication UM-SG-MAP-84-01. University of Maryland, College Park.
- Wolke, R. E., D. S. Wyand, and L. H. Khairallah. 1970. A light and electron microscope study of epitheliocystis disease in the gills of Connecticut striped bass (*Morone saxatilis*) and white perch (*Morone americanus*). *Journal of Comparative Pathology* 80:559-563.

- Wolters, W. R., G. S. Libey, and C. L. Chrisman. 1982. The effect of triploidy on the growth and gonad development of channel catfish. *Transactions of the American Fisheries Society* 111:102-105.
- Woods, L. C., III, J. H. Kerby, and M. T. Huish. 1983. Estuarine cage culture of hybrid striped bass. *Journal of the World Mariculture Society* 14:595-612.
- Woods, L. C., III, J. H. Kerby, and M. T. Huish. 1985a. Culture of hybrid striped bass to marketable size in circular tanks. *Progressive Fish-Culturist* 47:147-153.
- Woods, L. C., III, J. H. Kerby, M. T. Huish, G. M. Gafford, and W. L. Rickards. 1981. Circular tank for intensive culture of hybrid striped bass. *Progressive Fish-Culturist* 43:199-200.
- Woods, L. C., III, J. C. Lockwood, J. H. Kerby, and M. T. Huish. 1985b. Feeding ecology of hybrid striped bass (*Morone saxatilis* x *M. chrysops*) in culture ponds. *Journal of the World Mariculture Society* 16:71-81.
- Woods, L. C., III, J. G. Woiwode, M. A. McCarthy, D. D. Theisen, and R. O. Bennett. 1990. Non-induced spawning of captive striped bass in tanks. *Progressive Fish-Culturist* 52:201-202.
- Worth, S. G. 1884. Report upon the propagation of striped bass at Weldon, N. C., in the spring of 1884. *Bulletin of the United States Fish Commission* 4(15):225-230.
- Wright, J. C. 1965. Population dynamics and production of *Daphnia* in Canyon Ferry Reservoir, Montana. *Limnology and Oceanography* 10:583-590.
- Yeager, D. M. 1985. Ultrasonic telemetry of striped bass x white bass hybrids in the Escambia River, Florida. *Proceedings of the Annual Conference Southeastern Association of Fish and Wildlife Agencies* 36:62-73.
- Zeigler, T. R., L. C. Woods III, and J. Gabaudan. 1984. Striped bass feeds and feeding. Pages 151-175 in J. P. McCraren, editor. *The aquaculture of striped bass: a proceedings*. Maryland Sea Grant Publication UM-SG-MAP-84-01. University of Maryland, College Park.

APPENDIX A

Conversion Tables and Aquaculture Tips

Table A.1. Guide to recommended well casing sizes for various pumping rates.

Anticipated Well Yield (gpm)	Nominal Size of Pump Bowls (inches)	Smallest Size Well Casting (inches)*	Optimum Size of Well Casting (inches)
150 to 400	6	8 ID	10 ID
350 to 650	8	10 ID	12 ID
600 to 900	10	12 ID	14 OD
850 to 1,300	12	14 OD	16 OD
1,200 to 1,800	14	16 OD	20 OD
1,600 to 3,000	16	20 OD	24 OD

* ID refers to inside diameter and OD refers to outside diameter.

The above values are not limiting because variable factors are water level, yield of water bearing formation and pressure developed in well.

Table A.2. Approximate discharge rates from deep wells of various sizes.

Well Size (in inches)	Maximum Discharge (gpm)
4	90
6	400
8	600
10	1,000
12	2,000

Table A.3. Estimated average discharge rates for short drainpipes in fish ponds of various sizes with low head pressure.¹

Diameter of Pipe (Inches)	Approximate Discharge (gpm)
4	125
6	350
8	600
10	1,000
12	1,600
14	2,400

¹To estimate the drain time in days for a pond using various sizes of drainpipe, use the formula below:

$$\frac{\text{Acre-feet water} \times 325,851}{\text{Discharge gpm} \times 1440} = \text{Drain time in days}$$

Table A.4. Composition of some common inorganic fertilizers.

Fertilizer	Percentage ¹		
	N	P ₂ O ₅	K ₂ O
Ammonium nitrate	33-35	-	-
Ammonium sulfate	20-21	-	-
Calcium nitrate	15.5	-	-
Ammonium phosphates	11-16	20-48	-
Muriate of potash	-	-	50-62
Potassium nitrate	13	-	44
Potassium sulfate	-	-	50
Sodium nitrate	16	-	-
Superphosphate (ordinary)	-	18-20	-
Superphosphate (double/triple)	-	32-54	-
Urea	45	-	-

Refer to the information on the fertilizer bag or label to determine the grade for a specific fertilizer.

¹N refers to nitrogen; P₂O₅ refers to phosphorus; and K₂O refers to potassium.

Table A.5. Number of water samples required from ponds to estimate the averages of water quality variables with a 95% certainty that errors will not exceed the specified values.

Water Quality Variable	Number of Water Samples Per Determination
Dissolved Oxygen	
± 0.5 ppm	6
± 1.0 ppm	2
pH	
± 0.5 unit	1
± 1.0 unit	1
Temperature	
± 0.5°C	2
± 1.0°C	1
Total Hardness	
± 1.0 ppm	1
Secchi disk (underwater) visibility	
± 5 cm	7
± 10 cm	2

Table A.6. Solubility of oxygen in parts per million (ppm) in fresh water at various temperatures and at a pressure of 760 mm Hg (sea level).

Temperature		Oxygen Concentration (ppm)	Temperature		Oxygen Concentration (ppm)
°F	°C		°F	°C	
32	0	14.6	69.8	21	9.0
33.8	1	14.2	71.6	22	8.8
35.6	2	13.8	73.4	23	8.7
37.4	3	13.5	75.2	24	8.5
39.2	4	13.1	77	25	8.4
41	5	12.8	78.8	26	8.2
42.8	6	12.5	80.6	27	8.1
44.6	7	12.2	82.4	28	7.9
46.4	8	11.9	84.2	29	7.8
48.2	9	11.6	86	30	7.6
50	10	11.3	87.8	31	7.5
51.8	11	11.1	89.6	32	7.4
53.6	12	10.8	91.4	33	7.3
55.4	13	10.6	93.2	34	7.2
57.2	14	10.4	95.0	35	7.1
59	15	10.2	96.8	36	7.0
60.8	16	10.0	98.6	37	6.8
62.6	17	9.7	100.4	38	6.7
64.4	18	9.5	102.2	39	6.6
66.2	19	9.4	104.0	40	6.5
68	20	9.2			

Table A.7. Altitude correction factor for the solubility of oxygen in fresh water.

Atmospheric Pressure or Equivalent Altitude (mm HG)	= (Ft.)	Correction Factor
775	540	1.02
760	0	1.00
745	542	.98
730	1094	.96
714	1688	.94
699	2274	.92
684	2864	.90
669	3466	.88
654	4082	.86
638	4756	.84
623	5403	.82
608	6065	.80
593	6744	.78
578	7440	.76
562	8204	.74
547	8939	.72
532	9694	.70
517	10472	.68
502	11273	.66

Example: Solubility of oxygen at sea level (760 mm Hg) at 20°C is 9.2 ppm. The Solubility of oxygen at an altitude of 1,688 feet in 20°C water is 9.2 ppm x 0.94 (Correction Factor) = 8.65 ppm.

Table A.8. Solubility of oxygen in water exposed to water saturated air (ppm).

Temp °C	Salinity (ppt)								
	0	5	10	15	20	25	30	35	40
0	14.60	14.11	13.64	13.18	12.74	12.31	11.90	11.50	11.11
1	14.20	13.73	13.27	12.83	12.40	11.98	11.59	11.20	10.83
2	13.81	13.37	12.91	12.49	12.07	11.67	11.29	10.91	10.55
3	13.45	13.00	12.58	12.16	11.76	11.38	11.00	10.64	10.29
4	13.09	12.67	12.25	11.85	11.47	11.09	10.73	10.38	10.04
5	12.76	12.34	11.94	11.56	11.18	10.82	10.47	10.13	9.80
6	12.44	12.04	11.65	11.27	10.91	10.56	10.22	9.89	9.57
7	12.13	11.74	11.37	11.00	10.65	10.31	9.98	9.66	9.35
8	11.83	11.46	11.09	10.74	10.40	10.07	9.75	9.44	9.14
9	11.55	11.19	10.83	10.49	10.16	9.84	9.53	9.23	8.94
10	11.28	10.93	10.58	10.25	9.93	9.62	9.32	9.03	8.75
11	11.02	10.67	10.34	10.02	9.71	9.41	9.12	8.84	8.56
12	10.77	10.43	10.11	9.80	9.50	9.21	8.92	8.65	8.38
13	10.53	10.20	9.89	9.59	9.30	9.01	8.74	8.47	8.21
14	10.29	9.98	9.68	9.38	9.10	8.82	8.56	8.30	8.04
15	10.97	9.77	9.47	9.19	8.91	8.64	8.38	8.13	7.88
16	9.86	9.56	9.28	9.00	8.73	8.47	8.21	7.97	7.73
17	9.65	9.36	9.09	8.82	8.55	8.30	8.05	7.81	7.58
18	9.45	9.17	8.90	8.64	8.39	8.14	7.90	7.66	7.44
19	9.26	8.99	8.73	8.47	8.22	7.98	7.75	7.52	7.30
20	9.08	8.81	8.56	8.31	8.07	7.83	7.60	7.38	7.17
21	8.90	8.64	8.39	8.15	7.91	7.69	7.46	7.25	7.04
22	8.73	8.48	8.23	8.00	7.77	7.55	7.33	7.12	6.91
23	8.56	8.32	8.08	7.85	7.63	7.41	7.20	6.99	6.79
24	8.40	8.16	7.93	7.71	7.49	7.28	7.07	6.87	6.68
25	8.24	8.01	7.79	7.57	7.36	7.15	6.95	6.75	6.57
26	8.09	7.87	7.65	7.44	7.23	7.03	6.83	6.64	6.46
27	7.95	7.73	7.52	7.31	7.11	6.91	6.72	6.53	6.35
28	7.81	7.59	7.39	7.18	6.98	6.79	6.61	6.42	6.25
29	7.67	7.46	7.26	7.06	6.87	6.68	6.50	6.32	6.15
30	7.54	7.34	7.14	6.94	6.76	6.57	6.39	6.22	6.05
31	7.41	7.21	7.02	6.83	6.65	6.47	6.29	6.12	5.96
32	7.29	7.09	6.90	6.72	6.54	6.36	6.19	6.03	5.87
33	7.17	6.98	6.79	6.61	6.44	6.27	6.10	5.94	5.78
34	7.05	6.86	6.68	6.51	6.34	6.17	6.01	5.85	5.69
35	6.94	6.75	6.58	6.41	6.24	6.07	5.92	5.76	5.61
36	6.82	6.65	6.47	6.31	6.14	5.98	5.83	5.68	5.53
37	6.72	6.54	6.37	6.21	6.05	5.89	5.74	5.59	5.45
38	6.61	6.44	6.27	6.12	5.96	5.81	5.66	5.51	5.37
39	6.51	6.34	6.18	6.03	5.87	5.72	5.58	5.44	5.30
40	6.41	6.25	6.09	5.94	5.79	5.64	5.50	5.36	5.22

Table A.9. Hydrometer reading conversions at any temperature to specific gravity at 15°C.

Observed Hydrometer Reading	Temperature (°C)							
	0	5	10	15	20	25	30	35
0.9991	-3	-6	-5	0	8	18	32	47
1.0000	-4	-6	-5	0	8	19	32	47
1.0007	-4	-7	-5	0	8	19	32	48
1.0015	-5	-7	-5	0	8	19	33	48
1.0023	-5	-7	-5	0	8	19	33	48
1.0030	-6	-7	-5	0	8	19	33	48
1.0038	-6	-8	-6	0	8	20	33	49
1.0046	-6	-8	-6	0	9	20	34	49
1.0053	-6	-8	-6	0	9	20	34	49
1.0061	-7	-8	-6	0	9	20	34	50
1.0069	-8	-8	-6	0	9	20	34	50
1.0076	-8	-9	-6	0	9	20	35	50
1.0084	-8	-9	-6	0	9	20	35	50
1.0092	-9	-9	-6	0	9	21	35	51
1.0099	-9	-9	-6	0	9	21	35	51
1.0107	-10	-10	-6	0	9	21	36	51
1.0114	-10	-10	-6	0	9	21	36	51
1.0122	-10	-10	-7	0	10	21	36	52
1.0130	-11	-10	-7	0	10	22	36	52
1.0137	-11	-11	-7	0	10	22	36	52
1.0145	-12	-11	-7	0	10	22	37	53
1.0153	-12	-11	-7	0	10	22	37	53
1.0160	-12	-11	-7	0	10	22	37	53
1.0168	-12	-12	-7	0	10	22	37	53
1.0176	-13	-12	-7	0	10	23	38	54
1.0183	-13	-12	-7	0	10	23	38	54
1.0191	-14	-12	-8	0	10	23	38	54
1.0199	-14	-12	-8	0	10	23	38	54
1.0206	-14	-13	-8	0	10	23	38	55
1.0214	-14	-13	-8	0	10	23	38	55
1.0222	-15	-13	-8	0	11	23	39	55
1.0229	-15	-13	-8	0	11	24	39	55
1.0237	-16	-14	-8	0	11	24	39	55
1.0245	-16	-14	-8	0	11	24	39	56
1.0252	-16	-14	-8	0	11	24	39	56
1.0260	-17	-14	-8	0	11	24	40	56
1.0268	-17	-14	-9	0	11	24	40	56

Source: Spotte, Stephen. 1979. *Seawater Aquariums*, Wiley & Sons, New York.

Table A.10. Specific gravity and salinities.

Specific Gravity/Salinity (ppt)		Specific Gravity/Salinity (ppt)	
0.9991	0.0	1.0134	18.5
0.9995	0.5	1.0137	19.0
1.0000	1.0	1.0141	19.5
1.0003	1.5	1.0145	20.0
1.0007	2.0	1.0149	20.5
1.0011	2.5	1.0153	21.0
1.0015	3.0	1.0157	21.5
1.0019	3.5	1.0160	22.0
1.0023	4.0	1.0164	22.5
1.0026	4.5	1.0168	23.0
1.0030	5.0	1.0172	23.5
1.0034	5.5	1.0176	24.0
1.0038	6.0	1.0180	24.5
1.0042	6.5	1.0183	25.0
1.0046	7.0	1.0187	25.5
1.0049	7.5	1.0191	26.0
1.0053	8.0	1.0195	26.5
1.0057	8.5	1.0199	27.0
1.0061	9.0	1.0202	27.5
1.0065	9.5	1.0206	28.0
1.0069	10.0	1.0210	28.5
1.0072	10.5	1.0214	29.0
1.0076	11.0	1.0218	29.5
1.0080	11.5	1.0222	30.0
1.0084	12.0	1.0226	30.5
1.0088	12.5	1.0229	31.0
1.0092	13.0	1.0233	31.5
1.0095	13.5	1.0237	32.0
1.0099	14.0	1.0241	32.5
1.0103	14.5	1.0245	33.0
1.0107	15.0	1.0248	33.5
1.0111	15.5	1.0252	34.0
1.0114	16.0	1.0256	34.5
1.0118	16.5	1.0260	35.0
1.0122	17.0	1.0264	35.5
1.0126	17.5	1.0268	36.0
1.0130	18.0		

American Public Health Association, American Water Works Association, and Water Pollution Control Federation, 1975. *Standard Methods for the Examination of Water and Wastewater*, 14th Edition, American Public Health Association, Washington, D.C.

Table A.11. Temperature conversion chart (°C - °F).

°C	°F	°C	°F
0	32.0	21	69.8
1	33.8	22	71.6
2	35.6	23	73.4
3	37.4	24	75.2
4	39.2	25	77.0
5	41.0	26	78.8
6	42.8	27	80.6
7	44.6	28	82.4
8	46.4	29	84.2
9	48.2	30	86.0
10	50.0	31	87.8
11	51.8	32	89.6
12	53.6	33	91.4
13	55.4	34	93.2
14	57.2	35	95.0
15	59.0	36	96.8
16	60.8	37	98.6
17	62.6	38	100.4
18	64.4	39	102.2
19	66.2	40	104.0
20	68.0		

Table A.12. Temperature conversion chart (°F - °C).

°F	°C	°F	°C	°F	°C
32	0.0	55	12.8	78	25.6
33	0.6	56	13.3	79	26.1
34	1.1	57	13.9	80	26.7
35	1.7	58	14.4	81	27.2
36	2.2	59	15.0	82	27.8
37	2.8	60	15.6	83	28.3
38	3.3	61	16.1	84	28.9
39	3.9	62	16.7	85	29.4
40	4.4	63	17.2	86	30.0
41	5.0	64	17.8	87	30.6
42	5.6	65	18.3	88	31.1
43	6.1	66	18.9	89	31.7
44	6.7	67	19.4	90	32.2
45	7.2	68	20.0	91	32.8
46	7.8	69	20.6	92	33.3
47	8.3	70	21.1	93	33.9
48	8.9	71	21.7	94	34.4
49	9.4	72	22.2	95	35.0
50	10.0	73	22.8	96	35.6
51	10.6	74	23.3	97	36.1
52	11.1	75	23.9	98	36.7
53	11.7	76	24.4	99	37.2
54	12.2	77	25.0	100	37.8

Table A.13. Conversions for units of length.

From	To				
	Centimeter	Meter	Inch	Feet	Yard
Centimeter	1	0.01	0.0328	0.0328	0.0190
Meter	100	1	39.37	3.281	1.0936
Inch	2.540	0.054	1	0.0833	0.0278
Feet	30.48	0.3048	12	1	0.3333
Yard	91.44	0.9144	36	3	1

Table A.14. Conversions for units of weight.

From	To				
	Gram	Kilogram	Grain	Ounce	Pound
Gram	1	0.001	15.43	0.0353	0.0022
Kilogram	1000	1	1.54×10^4	35.27	2.205
Grain	0.0648	6.48×10^{-5}	1	0.0023	1.43×10^4
Ounce	28.35	0.0284	437.5	1	0.0625
Pound	453.6	0.4536	7000	16	1

Table A.15. Conversions for one unit of volume to another unit of volume.

From	To								
	cm ³	liter	m ³	in ³	ft ³	fl oz	fl pt	fl qt	gallon
cm ³	1	0.001	1×10 ⁻⁶	0.0610	3.53×10 ⁻⁵	0.0338	0.00211	0.00106	2.64×10 ⁻⁴
liter	1000	1	0.001	60.98	0.0353	33.81	2.113	1.057	0.02642
m ³	1×10 ⁶	1000	1	6.1×10 ⁴	5.31	3.38×10 ⁴	2113	1057	264.2
in ³	16.39	0.0164	1.64×10 ⁻⁵	1	5.79×10 ⁴	0.5541	0.0346	0.0173	0.0043
ft ³	2.83×10 ⁴	28.32	0.0283	1728	1	957.5	59.84	29.92	7.481
fl oz	29.57	0.0296	2.95×10 ⁻⁵	1.805	0.00104	1	0.0625	0.0313	0.0078
fl pt	473.2	0.4732	4.73×10 ⁻⁴	28.88	0.0167	16	1	0.5000	0.1250
fl qt	946.4	0.9463	9.46×10 ⁻⁴	57.75	0.0334	32	2	1	0.2500
gallon	3785	3.785	0.0038	231.0	0.1337	128	8	4	1

Table A.16. Conversion for parts per million, proportion and percent.

Parts per million	Proportion	Percent
0.1	1:10,000,000	0.00001
0.25	1:4,000,000	0.000025
1.0	1:1,000,000	0.0001
2.0	1:500,000	0.0002
3.0	1:333,333	0.0003
4.0	1:250,000	0.0004
5.0	1:200,000	0.0005
8.4	1:119,047	0.00084
10.0	1:100,000	0.001
15.0	1:66,667	0.0015
20.0	1:50,000	0.002
25.0	1:40,000	0.0025
50.0	1:20,000	0.005
100.0	1:10,000	0.01
150.0	1:6,667	0.015
167.0	1:6,000	0.0167
200.0	1:5,000	0.02
250.0	1:4,000	0.025
500.0	1:2,000	0.05
1,667.0	1:600	0.1667
5,000.0	1:200	0.5
6,667.0	1:150	0.6667
30,000.0	1:33	3.0

Table A.17. Weight of chemical that must be added to one unit volume of water to give one part per million (p.p.m.).

2.72 pounds per acre-foot	= 1 p.p.m.
1,233 grams per acre-foot	= 1 p.p.m.
0.0283 gram per cubic foot	= 1 p.p.m.
0.0000624 pound per cubic foot	= 1 p.p.m.
0.0038 gram per gallon	= 1 p.p.m.
0.0584 grain per gallon	= 1 p.p.m.
1 milligram per liter	= 1 p.p.m.
0.001 gram per liter	= 1 p.p.m.
8.34 pounds per million gallons of water	= 1 p.p.m.

Table A.18. Pounds of active chemical needed to give desired concentration in parts per million per specific volume in acre-feet.

Concentration desired, parts per million	Acre-feet							
	0.5	1	2	5	10	20	50	100
0.1	0.14	0.27	0.54	1.36	2.72	5.44	13.6	27.2
0.25	0.34	0.68	1.36	3.40	68.0	13.6	34.0	68.0
0.5	0.68	1.36	2.72	6.80	13.6	27.2	68.0	136.0
1.0	1.36	2.72	5.44	13.6	27.2	54.4	136.0	272.0
2.0	2.72	5.44	10.9	27.2	54.4	108.8	272.0	544.0
3.0	4.08	8.16	16.3	40.8	81.6	163.2	408.0	816.0
4.0	5.44	10.9	21.8	54.4	108.8	217.6	544.0	1088.0
5.0	6.75	13.6	27.2	68.0	136.0	272.0	680.0	1360.0
10.0	13.6	27.2	54.4	136.0	272.0	544.0	1360.0	2720.0

Table A.19. Grams of active chemical needed to give desired concentration in parts per million per specific volume in cubic feet.

Concentration, parts per million	Cubic feet								
	10	50	100	200	300	400	500	1000	2000
0.5	0.14	0.7	1.4	2.8	4.3	5.7	7.1	14.2	28.4
1	0.28	1.4	2.8	5.7	8.5	11.3	14.2	28.3	56.6
2	0.57	2.8	5.7	11.3	17.0	22.6	28.3	56.6	113.2
3	0.85	4.2	8.5	17.0	25.5	34.0	42.5	84.9	169.8
4	1.1	5.7	11.3	22.6	34.0	45.3	56.6	113.2	226.4
5	1.4	7.1	14.1	28.3	43.5	56.6	70.7	141.5	283.0
10	2.8	14.1	28.3	56.6	84.9	113.2	141.5	283.0	566.0
15	4.2	21.2	42.5	84.9	127.4	169.8	212.3	424.5	849.0
20	5.7	28.3	56.6	113.2	169.8	226.4	283.0	566.0	1132.0
25	7.1	35.4	70.8	141.5	212.3	283.0	353.8	707.5	1414.0

Table A.20. Grams of active chemical needed to give desired concentration in parts per million per specific volume in gallons.

Concentration, parts per million	Gallons									
	10	50	100	200	300	400	500	1000	2000	5000
0.5	0.02	0.10	0.19	0.38	0.57	0.76	0.95	1.90	3.80	9.50
1	0.04	0.19	0.38	0.76	1.14	1.52	1.90	3.80	7.60	19.00
2	0.08	0.38	0.76	1.52	2.28	3.04	3.80	7.60	15.20	38.00
3	0.11	0.57	1.14	2.28	3.42	4.56	5.70	11.40	22.80	57.00
4	0.15	0.76	1.52	3.04	4.56	6.08	7.60	15.20	30.40	76.00
5	0.19	0.95	1.90	3.80	5.70	7.60	9.50	19.00	38.00	95.00
10	0.38	1.90	3.80	7.60	11.40	15.20	19.00	38.00	76.00	190.00
15	0.57	2.85	5.70	11.40	17.10	22.80	28.50	57.00	114.00	285.00
20	0.76	3.80	7.60	15.20	22.80	30.40	38.00	76.00	152.00	380.00
25	0.95	4.75	9.50	19.00	28.50	38.00	47.50	95.00	190.00	475.00

Table A.21. Grams of active drug needed per 100 pounds of feed at various feeding levels and treatment rates.

Percent fed per pound of body weight	Grams active drug needed per 100 lb. fish per day					
	2.0	2.5	3.0	4.0	4.5	10.0
1.0	200	250	300	400	50	1,000
1.2	167	208	250	333	375	833
1.4	143	179	214	286	321	714
1.6	125	156	188	250	281	625
1.8	111	139	167	222	250	556
2.0	100	125	150	200	225	500
2.2	91	114	136	182	205	455
2.4	83	104	125	167	188	417
2.6	77	96	115	154	173	385
2.8	71	89	107	143	161	357
3.0	67	83	100	133	150	333
3.2	63	78	94	125	141	313
3.4	59	74	88	118	132	294
3.6	56	69	83	111	125	278
3.8	53	66	79	105	118	263
4.0	50	63	75	100	113	250
4.2	48	60	71	95	107	238
4.4	45	57	68	91	102	227
4.6	43	54	65	87	98	217
5.0	40	50	60	80	90	200
5.5	36	45	55	73	82	182
6.0	33	42	50	67	75	167

APPENDIX B

The equipment and suppliers listed in this section are commonly used in striped bass culture, and are intended as suggestions only. The editors, authors, Striped Bass Committee, and the sponsors do not endorse any of the suggested trade names, manufacturers, or vendors. If the readers are interested in a more detailed list of vendors, it is suggested they subscribe to one or several of the various trade magazines currently available.

Aerators and Blowers

Air-O-Lator Corporation
8100 Paseo Street
Kansas City, MO 64131
816-363-4242
FAX: 816-363-2322

AREA, Inc.
P. O. Box 1303
Homestead, FL 33090
305-248-4205
FAX: 305-248-1756

The Power House, Inc.
2682 W. Patapsco Avenue
Baltimore, MD 21122
301-525-1111
FAX: 301-525-2851

Aquatic Eco-Systems
2056 Apopka Boulevard
Apopka, FL 32703
407-886-3939
FAX: 407-886-6787

House Manufacturing Co.
Highway 1, P. O. Box 214
Cherry Valley, AR 72324
501-588-3307
FAX: 501-588-3517

Air Diffusers

AirSep Corporation
84 Aero Drive
Buffalo, NY 14225
716-626-0202
FAX: 716-626-0028

Aquatic Eco-Systems
2056 Apopka Boulevard
Apopka, FL 32703
407-886-3939
FAX: 407-886-6787

AREA, Inc.
P. O. Box 1303
Homestead, FL 33090
305-248-4205
FAX: 305-248-1756

Micro-Por, Inc.
P. O. Box 12218
Wichita, KS 67277
316-685-9120
FAX: 316-685-4994

Argent Chemical Labs
8702 152nd Avenue NE
Redmond, WA 98052
206-885-3777
FAX: 206-885-2112

Fritz Chemical Co.
Aquaculture Division
P. O. Drawer 17040
Dallas, TX 75217
FAX: 214-289-1791

Agitators

Anderson Bait Distributors
P. O. Drawer 290
Highway 70 West
Lonoke, AR 72086
501-676-3166

Nylon Net Company
615 E. Bodley, P. O. Box 592
Memphis, TN 38101
800-238-7529
FAX: 901-774-8130

Memphis Net & Twine Co.
2481 Matthews Avenue
Memphis, TN 38108-0331
901-458-2656
FAX: 901-458-1601

Air Line Tubing

Nolt's Ponds, Inc.
3708-12 Quarry Road
Silver Spring, PA 17575
800-233-0300

VWR Scientific Sales
P. O. Box 20158
Atlanta, GA 30325
404-351-3872

Aquaria Supplies

ACRY-TEC Aquarium Sales & Service
7352 Trade Street
San Diego, CA 92121
619-271-0045
FAX: 619-271-0454

4410-B West Victory Blvd
Burbank, CA 91505
818-841-0097
FAX: 818-841-1369

AREA, Inc.
P. O. Box 1303
Homestead, FL 33090
305-248-4205
FAX: 305-248-1756

Nolt's Ponds, Inc.
3708-12 Quarry Road
Silver Spring, PA 17575
800-233-0300

Fritz Chemical Co.
Aquaculture Division
P. O. Drawer 17040
Dallas, TX 75217
214-289-1791

Aquatic Weed Control

Applied Biochemists, Inc.
5300 W. County Line Road
Mequon, WI 53092
800-558-5106
FAX: 414-242-5432

Aquashade, Inc.
P. O. Box 198
Eldred, NY 12732
914-557-8077
FAX: 914-557-8015

Crescent Research Chemicals
4331 E. Western Star Boulevard
Phoenix, AZ 85044
602-893-9234

Argent Chemical Labs
8702 152nd Avenue NE
Redmond, WA 98052
206-885-3777
FAX: 206-885-2112

Bags, Plastic

J. V. Manufacturing Corporation
50 East 10th Court
Hialeah, FL 33010
305-885-4666

Nolt's Ponds, Inc.
3708-12 Quarry Road
Silver Spring, PA 17575
800-233-0300

Bins, Feed

Chore-Time Equipment
P. O. Box 2000
Milford, IN 46542
219-658-4101
FAX: 219-658-4171

Bird Control Equipment

Av-Alarm Corporation
675-D Conger Street
Eugene, OR 97402
503-342-1271
FAX: 503-342-1283

Inter Net, Inc.
2730 Nevada Avenue, N.
Minneapolis, MN 55427
800-328-8456
FAX: 612-541-9690

Boxes, Shipping

J. V. Manufacturing Corporation
50 East 10th Court
Hialeah, FL 33010
305-885-4666

Fibertek, Inc.
P. O. Box 951
Connellsville, PA 15425
412-626-1200
FAX: 412-626-0150

Chemicals and Drugs

Argent Chemical Labs
8702 152nd Avenue NE
Redmond, WA 98052
206-885-3777
FAX: 206-885-2112

Fisher Scientific Co.
P. O. Box 829
Norcross, GA 30071
404-449-5050

Fritz Chemical Co.
P. O. Drawer 17040
Dallas, TX 75217
214-289-1791

VWR Scientific Sales
P. O. Box 20158
Atlanta, GA 30325
404-351-3872

Dip Nets, Seines

Anderson Bait Distributors
P. O. Drawer 290
Highway 70
Lonoke, AR 72086
501-676-3166

Duraframe Dip Net
Rt. 2, Box 166
West Viola, WI 54664
608-538-3140

Fritz Chemical Co.
P. O. Drawer 17040
Dallas, TX 75217
214-289-1791

Memphis Net & Twine Co.
2481 Matthews Avenue
Memphis, TN 38108-0331
901-458-2656
FAX: 901-458-1601

Nylon Net Company
615 E. Bodley, P. O. Box 592
Memphis, TN 38101
800-238-7529
FAX: 901-774-8130

Sterling Net Company
18 Label Street
Montclair, NJ 07042
201-783-9800
FAX: 201-783-9808

Electrofishing Equipment

Coffelt Electronics Co., Inc
3910 South Windermere Street
Englewood, CO 80110
303-761-3505
FAX: 303-762-1382

Smith-Root, Inc.
14014 Salmon Creek Avenue
Vancouver, WA 98686
206-573-0202
FAX: 503-286-1931

Feeders

Aquatic Eco-Systems
2056 Apopka Boulevard
Apopka, FL 32703
407-886-3939
FAX: 407-886-6787

Aquafarms Canada, Ltd.
R R 1
Feversham, ON NOC 1CO
Canada
519-922-2817
FAX: 519-922-2991

Babington Enterprises
Rt. 1, Box 263
Hagerman, ID 83332
208-837-4860

Chore-Time Equipment
P. O. Box 2000
Milford, IN 46542
219-658-4101
FAX: 219-658-4171

Lehman H. Feeder & Plow
Rt. 3, Box 5
Corpus Christi, TX 78415
512-855-0049

Indianola Metal Co.
3309 Highway 82 West
Indianola, MS 38751
601-887-2269

Neilsen Metal Industries
3501 Portland Road NE
Salem, OR 97303
503-585-0040
FAX: 503-362-3814

T. Skretting A. S.
P. O. Box 319
Stavanger 4001
Norway
04-586-000

Sort-Rite International, Inc.
P. O. Box 1805
Harlingen, TX 78551
512-423-2427
FAX: 512-423-2543

Sweeney Enterprises, Inc.
HCR 7, Box 2452
Boerne, TX 78006
512-537-4631

Zeigler Brothers, Inc.
P. O. Box 95
Gardners Station Road
Gardners, PA 17324
717-677-6181
FAX: 717-677-6826

Fish Tag Equipment

J. L. Darling Corporation
2212 Port of Tacoma Road
Tacoma, WA 98421
206-383-1714
FAX: 206-383-1722

Floy Tag Manufacturing
4616 Union Bay Place NE
Seattle, WA 98105
800-843-1172
FAX: 206-524-8260

BioSonics, Inc.
4520 Union Bay Place NE
Seattle, WA 98105
206-527-0905

Generators

Homelite Corporation
P. O. Box 7047
Charlotte, NC 28217
704-588-3200

Coffelt Electronics Co.
3910 South Windermere St
Englewood, CO 80110
303-761-3505
FAX: 303-762-1382

Smith-Root, Inc.
14014 NE Salmon Creek Avenue
Vancouver, WA 98686
206-573-0202

Graders

Memphis Net & Twine Co.
2481 Matthews Avenue
Memphis, TN 38108-0331
901-458-2656
FAX: 901-458-1601

Neilsen Metal Industries
3501 Portland Road NE
Salem, OR 97303
503-585-0040
FAX: 503-362-3814

Zeigler Brothers, Inc.
P. O. Box 95
Gardners Station Road
Gardners, PA 17324
717-677-6181
FAX: 717-677-6826

Fish Food

Murray Elevators
Silver Cup Fish Feeds
118 W 4800 So.
P. O. Box 7428
Murray, UT 84107
800-521-9092
FAX: 801-266-7126

Zeigler Brothers, Inc.
P. O. Box 95
Gardners Station Road
Gardners, PA 17324
717-677-6181
FAX: 717-677-6826

Aquafauna Bio-Marine, Inc.
P. O. Box 5
Hawthorne, CA 90250
213-973-5275
FAX: 213-676-9387

Brine Shrimp

Argent Chemical Labs
8702 152nd Avenue NE
Redmond, WA 98052
206-885-3777
FAX: 206-885-2112

Sanders Brine Shrimp Co.
3850 South 540 West
Ogden, UT 84405
801-393-5027
FAX: 801-621-3825

Aquafauna Bio-Marine, Inc.
P. O. Box 5
Hawthorne, CA 90250
213-973-5275
FAX: 213-676-9387

San Francisco Bay Brand
8239 Enterprise Drive
Newark, CA 94560
415-792-7200
FAX: 415-792-5360

Hatching Jars

Midland Plastics, Inc.
P. O. Box 423
3605 N. 126th Street
Brookfield, WI 53005
414-781-6520
FAX: 414-781-5438

Hatching Tanks

Red Ewald, Inc.
P. O. Box 519
Highway 181 South
Karnes City, TX 78118
512-780-3304
FAX: 512-780-4272

Rowland Fiberglass, Inc.
560 6th Street
P. O. Box 971
Ingleside, TX 78362
512-776-7753
FAX: 512-776-5400

Aquafarms Canada, Ltd.
R R 1
Feversham, ON NOC 1CO
Canada
519-922-2817

Solar Components
P. O. Box 237
Manchester, NH 03105
603-668-8186
FAX: 603-627-3110

Oil Absorbency Cloths

J. V. Manufacturing Corporation
50 East 10th Court
Hialeah, FL 33010
305-885-4666

Safeware Inc.
3812 West Street
Landover, MD 20785
301-322-2800
FAX: 301-773-6943

Plankton Nets

Aquafauna Bio-Marine, Inc.
P. O. Box 5
Hawthorne, CA 90250
213-973-5275
FAX: 213-676-9387

Wildco Supply Company
301 Cass Street
Saginaw, MI 48602
517-799-8100

Pond Liners

Permalon - Reef Industries
P. O. Box 750250
Houston, TX 77275-0250
713-943-0070

Liner Systems
8611 Bulkboard Drive
Alexandria, VA 22308
703-360-7777

Palco Lining
Box 526
2624 Hamilton Boulevard
South Plainfield, NJ 07080
201-753-6262

Perforated Metals

Ferguson Perforating & Wire
130-140 Earnest Street
Providence, RI 02905
401-941-8876

Pumps

W. W. Grainger
3825 Airport Highway
Birmingham, AL 35222
205-591-4222

Pacer Pump Company
One Lark Lane
Leola, PA 17540
717-656-0477
FAX: 717-656-0477

Aquafauna Bio-Marine, Inc.
P. O. Box 5
Hawthorne, CA 90250
213-973-5275
FAX: 213-676-9387

House Manufacturing
Highway 1
P. O. Box 214
Cherry Valley, AR 72324
501-588-3307
FAX: 501-588-3517

Aquatic Eco-Systems
2056 Apopka Boulevard
Apopka, FL 32703
407-886-3939
FAX: 407-886-6787

AREA, Inc.
P. O. Box 1303
Homestead, FL 33090
305-248-4205
FAX: 305-248-1756

Scales, Balances

Anderson Bait Distributors
P. O. Drawer 290
Highway 70 West
Lonoke, AR 72086
501-676-3166

Fritz Chemical Co.
Aquaculture Division
P. O. Drawer 17040
Dallas, TX 75217
214-289-1791

Arkansas Fish & Farm Supply
115 South Center Street
Lonoke, AR 72086
501-676-6564

Sort-Rite International
P. O. Box 1805
Harlingen, TX 78551
512-423-2427
FAX: 512-423-2543

Fisher Scientific Company
P. O. Box 829
Norcross, GA 30071
404-449-5050

Transport Tanks

Anderson Bait Distributors
P. O. Drawer 290
Highway 70 West
Lonoke, AR 72086
501-676-3166

Peterson Fiberglass
P. O. Box 158
300 Stariha Drive
Shell Lake, WI 54871
715-468-2306
Fax: 715-468-7923

Rowland Fiberglass, Inc.
560 6th Street
P. O. Box 971
Ingleside, TX 78362
512-776-7753
FAX: 512-776-5400

Saran, Screens, Nitex

National Filter Media Corporation
629 North 400 West
Salt Lake City, UT 84110
801-363-6736

Domestic Manufacturing
Highway 11 & Cunningham
P.O. Box 3548
Kingston, NC 28501
919-527-0042

Water Quality Test Kits, Meters

Hach Company
P.O.Box 389
Loveland, CO 80539
800-227-4224
FAX: 303-669-2923

Taylor Technologies
31 Loveton Circle
Sparks, MD 21152
301-472-4340
FAX: 301-771-4291

Leeds & Northrup Company
Sumneytown Pike MD 392
North Wales, PA 19454
215-699-2000
FAX: 215-699-3702

Zeigler Brothers, Inc.
P. O. Box 95
Gardners Station Road
Gardners, PA 17324
717-677-6181
FAX: 717-677-6826

Aquafauna Bio-Marine, Inc.
P. O. Box 5
Hawthorne, CA 90250
213-973-5275
FAX: 213-676-9387

Ryan Instruments, Inc.
8801 148th Avenue NE
P. O. Box 599
Redmond, WA 98073-0599
800-999-7926
FAX: 206-883-3766

LaMotte Chemical Products
Rt. 213N, P. O. Box 329
Chestertown, MD 21620
301-778-3100
FAX: 301-778-6394

YSI, Inc.
1725 Brannum Lane
Yellow Springs, OH 45387
513-767-7241
FAX: 513-767-9353

Hydrolab Corporation
P. O. Box 50116
Austin, TX 78763
512-255-8841
FAX: 512-255-3106

Orion Research, Inc.
529 Main Street
Boston, MA 02129
800-225-1480

Royce Instruments
13555 Gentilly Road
New Orleans, LA 70129
504-254-8888
FAX: 504-254-8855

